



RoHS compliant

FEATURES

- Terminal layout for simplifying PC board pattern design
- Capable of 25A high-capacity load switching with compact size
- Plastic sealed type

TYPICAL APPLICATIONS

- Power windows
- Auto door lock
- Power sunroof
- Electrically powered mirrors
- Powered seats
- Lift gates
- Slide door closers, etc. (for DC motor forward/reverse control circuits)

ORDERING INFORMATION

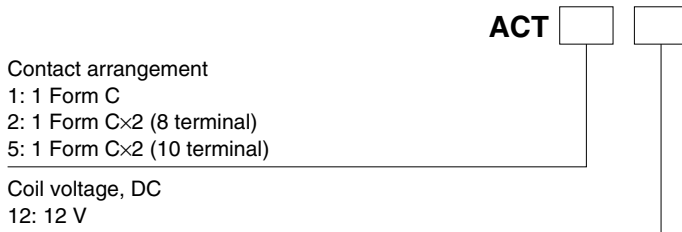

TYPES

Contact arrangement	Coil voltage	Part No.
1 Form C	12 V DC	ACT112
1 Form C × 2 (8 terminals type)		ACT212
1 Form C × 2 (10 terminals type)		ACT512

Standard packing; 1 Form C: Carton (tube) 30pcs. Case 1,500pcs.
 1 Form C × 2: Carton (tube) 30pcs. Case 900pcs.

RATING

1. Coil data

Nominal coil voltage	Pick-up voltage (at 20°C 68°F)	Drop-out voltage (at 20°C 68°F)	Nominal operating current [±10%] (at 20°C 68°F)	Coil resistance [±10%] (at 20°C 68°F)	Nominal operating power (at 20°C 68°F)	Usable voltage range
12V DC	Max. 7.2 V DC (Initial)	Min. 1.0 V DC (Initial)	66.7 mA	180Ω	800 mW	10 to 16V DC

Note: Other pick-up voltage types are also available. Please contact us for details.

CT (ACT)

2. Specifications

Characteristics	Item	Specifications	
Contact	Arrangement	1 Form C × 2, 1 Form C	
	Contact resistance (Initial)	N.O.: Typ 7mΩ, N.C.: Typ 10mΩ (By voltage drop 6V DC 1A)	
	Contact material	Ag alloy (Cadmium free)	
Rating	Nominal switching capacity (resistive load)	N.O.: 20 A 14V DC, N.C.: 10 A 14V DC	
	Max. carrying current (14V DC)*3	N.O.: 25 A for 1 hour, 35 A for 2 minutes at 20°C 68°F 20 A for 1 hour, 30 A for 2 minutes at 85°C 185°F	
	Nominal operating power	800 mW	
	Min. switching capacity (resistive load)*1	1 A 14V DC	
Electrical characteristics	Insulation resistance (Initial)	Min. 100 MΩ (at 500V DC, Measurement at same location as "Breakdown voltage" section.)	
	Breakdown voltage (Initial)	Between open contacts	500 Vrms for 1 min. (Detection current: 10mA)
		Between contacts and coil	500 Vrms for 1 min. (Detection current: 10mA)
	Operate time (at nominal voltage)	Max. 10ms (at 20°C 68°F, excluding contact bounce time) (Initial)	
	Release time (at nominal voltage)	Max. 10ms (at 20°C 68°F, excluding contact bounce time) (Initial)	
Mechanical characteristics	Shock resistance	Functional	Min. 100 m/s ² {10G} (Half-wave pulse of sine wave: 11ms; detection time: 10μs)
		Destructive	Min. 1,000 m/s ² {100G} (Half-wave pulse of sine wave: 6ms)
	Vibration resistance	Functional	10 Hz to 100 Hz, Min. 44.1 m/s ² {4.5G} (Detection time: 10μs)
		Destructive	10 Hz to 500 Hz, Min. 44.1 m/s ² {4.5G}, Time of vibration for each direction; X, Y direction: 2 hours, Z direction: 4 hours
Expected life	Mechanical	Min. 10 ⁷ (at 120 cpm)	
	Electrical	<Resistive load> Min. 10 ⁵ (at nominal switching capacity, operating frequency: 1s ON, 9s OFF) <Motor load> N.O. side: Min. 2 × 10 ⁵ (at Inrush 25A, Steady 5A 14 V DC), Min. 10 ⁵ (at 25A 14 V DC motor lock condition) N.C. side: Min. 2 × 10 ⁵ (at brake current 20A 14 V DC) (operating frequency: 0.5s ON, 9.5s OFF)	
Conditions	Conditions for operation, transport and storage*2	Ambient temperature: -40°C to +85°C -40°F to +185°F, Humidity: 5% R.H. to 85% R.H. (Not freezing and condensing at low temperature)	
	Max. operating speed	6 cpm (at nominal switching capacity)	
Mass		Twin type: approx. 8 g .28 oz, 1 Form C type: approx. 4 g .14 oz	

Notes: *1. This value can change due to the switching frequency, environmental conditions, and desired reliability level, therefore it is recommended to check this with the actual load.

*2. The upper operation ambient temperature limit is the maximum temperature that can satisfy the coil temperature rise value. Please refer to "Usage ambient condition" in CAUTIONS FOR USE OF AUTOMOTIVE RELAYS.

Please inquire if you will be using the relay in a high temperature atmosphere (110°C 230°F).

*3. Depends on connection conditions. Also, this does not guarantee repeated switching. We recommend that you confirm operation under actual conditions.

* If the relay is used continuously for long periods of time with coils on both sides in an energized condition, breakdown might occur due to abnormal heating depending on the carrying condition. Therefore, please inquire when using with a circuit that causes an energized condition on both sides simultaneously.

REFERENCE DATA

1-(1). Coil temperature rise (at room temperature)

Sample: ACT212, 3pcs.

Contact carrying current: 0A, 10A, 20A

Ambient temperature: Room temperature

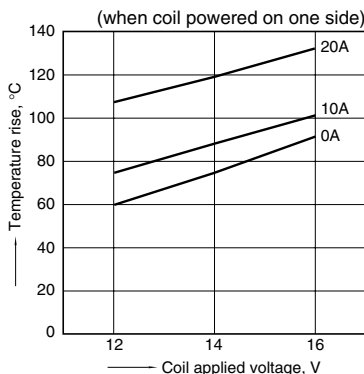

1-(2). Coil temperature rise (at 85°C 185°F)

Sample: ACT212, 3pcs.

Contact carrying current: 0A, 10A, 20A

Ambient temperature: 85°C 185°F

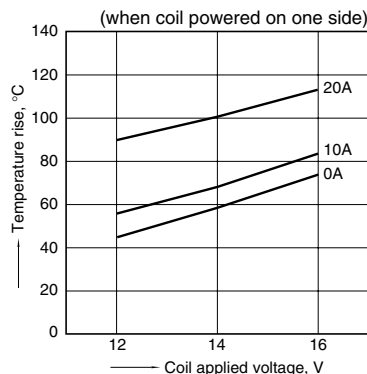

2. Max. switching capability (Resistive load, initial)

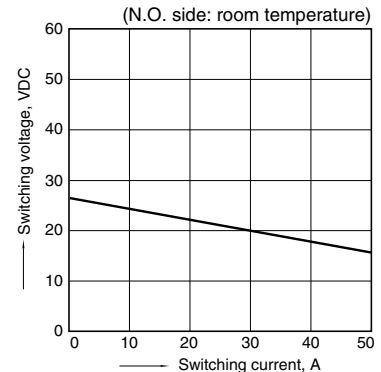

3. Ambient temperature and operating voltage range

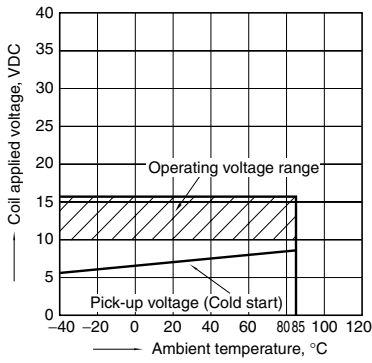

4. Distribution of pick-up and drop-out voltage
Sample: ACT212, 40pcs.

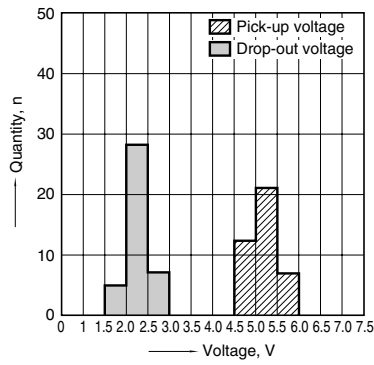

5. Distribution of operate and release time
Sample: ACT212, 40pcs.

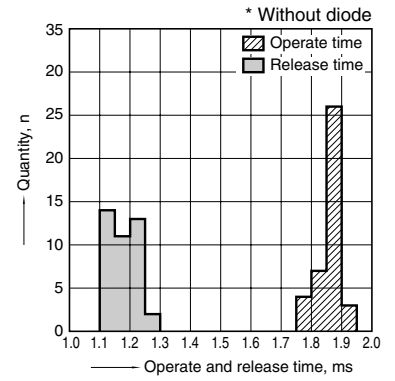

6-(1). Electrical life test (Motor free)

Sample: ACT212, 3pcs.
Load: Inrush 25A, steady 5A
Brake current: 13A 14V DC,
Power window motor actual load (free condition)
Operating frequency: ON 0.5s, OFF 9.5s
Ambient temperature: Room temperature
Circuit:

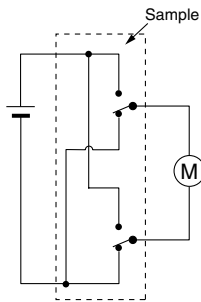

Change of pick-up and drop-out voltage

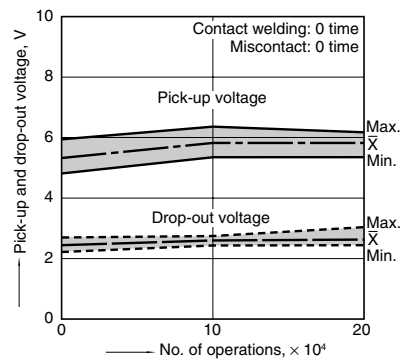

Change of contact resistance

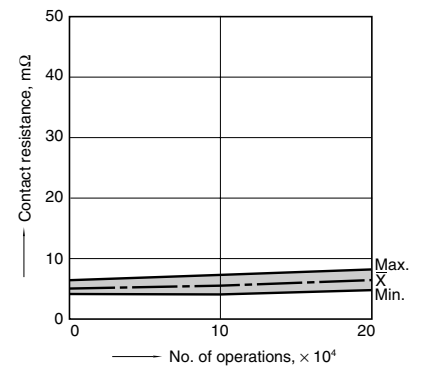

Load current waveform

Inrush current: 25A, Steady current: 6A
Brake current: 13A

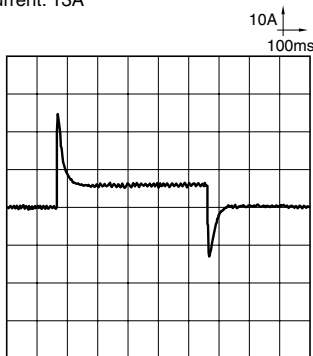

CT (ACT)

6-(2). Electrical life test (Motor lock)

Sample: ACT212, 3pcs.
 Load: 25A 14V DC
 Power window motor actual load (lock condition)
 Switching frequency: ON 0.5s, OFF 9.5s
 Ambient temperature: Room temperature
 Circuit:

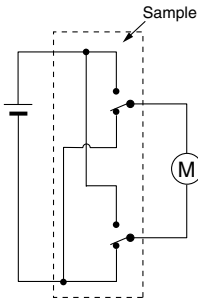

Change of pick-up and drop-out voltage

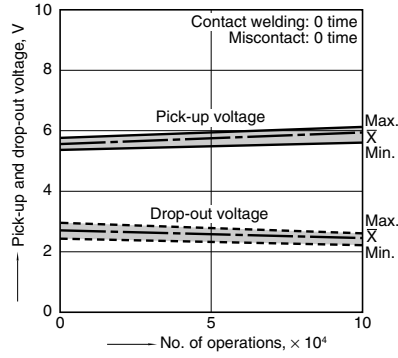

Change of contact resistance

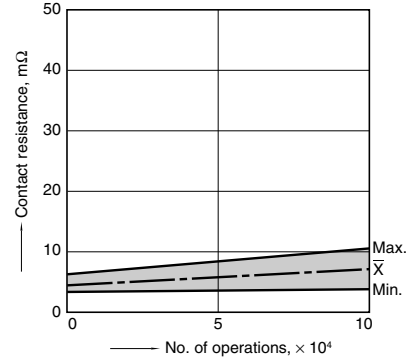

Load current waveform

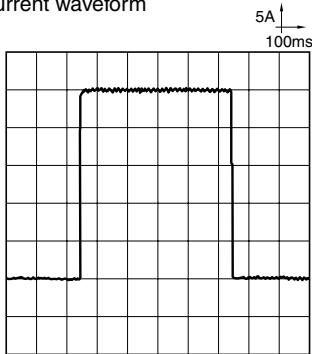

6-(3). Electrical life test (Motor lock)

Sample: ACT212, 3pcs.
 Load: 20A 14V DC,
 door lock motor actual load (Lock condition)
 Switching frequency: ON 0.3s, OFF 19.7s
 Ambient temperature: Room temperature
 Circuit:

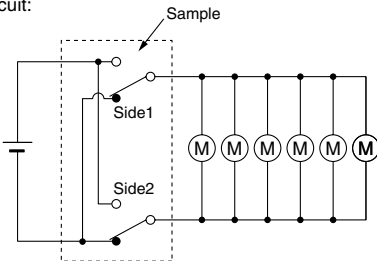

Change of pick-up and drop-out voltage

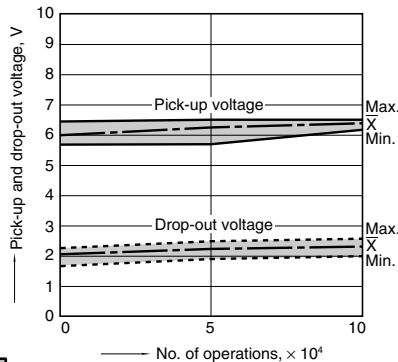

Change of contact resistance

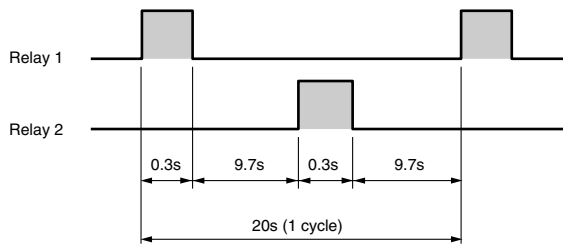
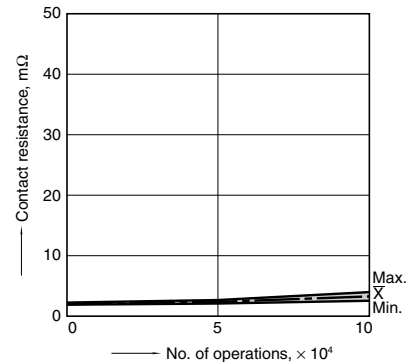

Load current waveform

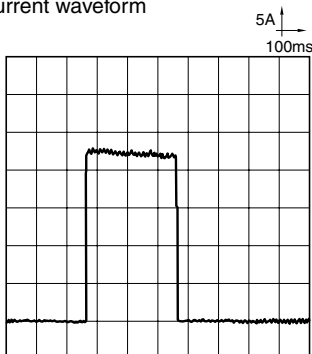

DIMENSIONS (mm inch)

The CAD data of the products with a **CAD Data** mark can be downloaded from: <http://industrial.panasonic.com/ac/e/>

1. Twin type (8 terminals)

External dimensions

PC board pattern (Bottom view)

CAD Data

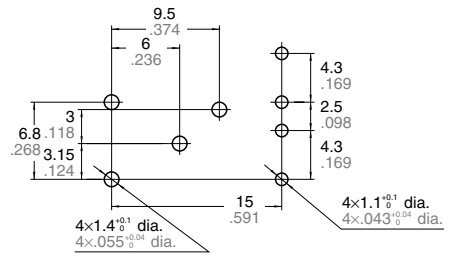
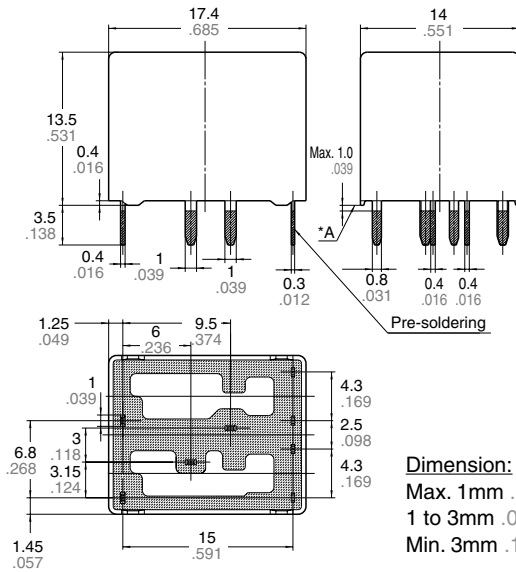

Tolerance: $\pm 0.1 \pm 0.04$

Schematic (Bottom view)

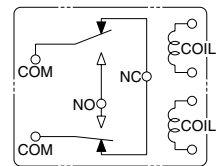

Dimension:
 Max. 1mm .039 inch: $\pm 0.1 \pm 0.04$
 1 to 3mm .039 to .118 inch: $\pm 0.2 \pm 0.08$
 Min. 3mm .118 inch: $\pm 0.3 \pm 0.12$

* Dimensions (thickness and width) of terminal is measured before pre-soldering.
 Intervals between terminals is measured at A surface level.

2. Twin type (10 terminals)

External dimensions

PC board pattern (Bottom view)

CAD Data

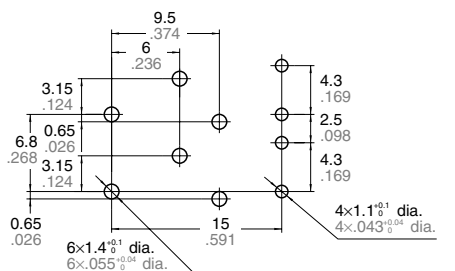
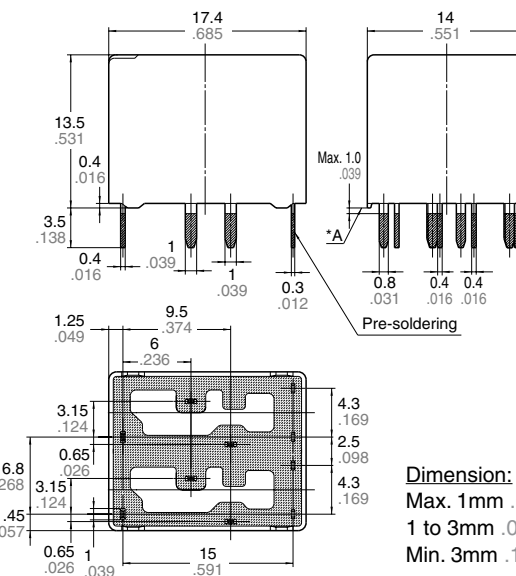

Tolerance: $\pm 0.1 \pm 0.04$

Schematic (Bottom view)

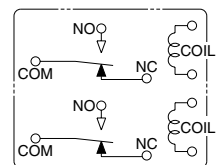

Dimension:
 Max. 1mm .039 inch: $\pm 0.1 \pm 0.04$
 1 to 3mm .039 to .118 inch: $\pm 0.2 \pm 0.08$
 Min. 3mm .118 inch: $\pm 0.3 \pm 0.12$

* Dimensions (thickness and width) of terminal is measured before pre-soldering.
 Intervals between terminals is measured at A surface level.

CT (ACT)

3. Slim 1c type

CAD Data



External dimensions

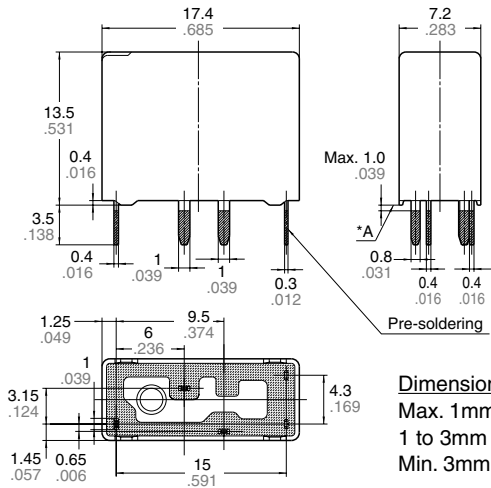

PC board pattern (Bottom view)

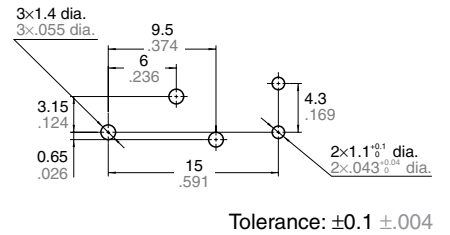

Schematic (Bottom view)

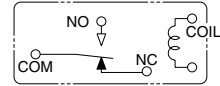

* Dimensions (thickness and width) of terminal is measured before pre-soldering.
Intervals between terminals is measured at A surface level.

EXAMPLE OF CIRCUIT

Forward/reverse control circuits of DC motor for power windows

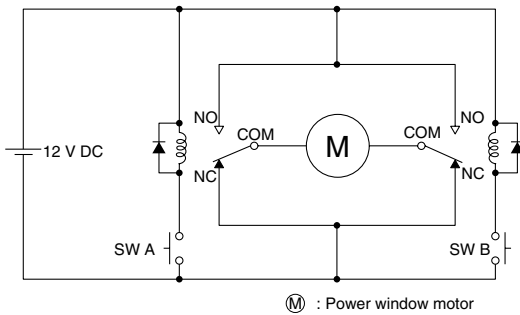

For general cautions for use, please refer to the “CAUTIONS FOR USE OF AUTOMOTIVE RELAYS”