

# BAV756S; BAW56 series

High-speed switching diodes

Rev. 05 — 26 November 2007

Product data sheet

## 1. Product profile

### 1.1 General description

High-speed switching diodes, encapsulated in small Surface-Mounted Device (SMD) plastic packages.

Table 1. Product overview

Type number	Package			Package configuration	Configuration
	NXP	JEITA	JEDEC		
BAV756S	SOT363	SC-88	-	very small	quadruple common anode/common cathode
BAW56	SOT23	-	TO-236AB	small	dual common anode
BAW56M	SOT883	SC-101	-	leadless ultra small	dual common anode
BAW56S	SOT363	SC-88	-	very small	quadruple common anode/common anode
BAW56T	SOT416	SC-75	-	ultra small	dual common anode
BAW56W	SOT323	SC-70	-	very small	dual common anode

### 1.2 Features

- High switching speed:  $t_{rr} \leq 4$  ns
- Low leakage current
- Small SMD plastic packages
- Low capacitance:  $C_d \leq 2$  pF
- Reverse voltage:  $V_R \leq 90$  V

### 1.3 Applications

- High-speed switching
- General-purpose switching

### 1.4 Quick reference data

Table 2. Quick reference data

Symbol	Parameter	Conditions	Min	Typ	Max	Unit
<b>Per diode</b>						
$I_R$	reverse current	$V_R = 80$ V	-	-	0.5	$\mu$ A
$V_R$	reverse voltage		-	-	90	V
$t_{rr}$	reverse recovery time		[1]	-	4	ns

[1] When switched from  $I_F = 10$  mA to  $I_R = 10$  mA;  $R_L = 100$   $\Omega$ ; measured at  $I_R = 1$  mA.

**2. Pinning information**

**Table 3. Pinning**

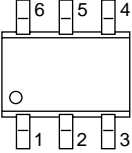
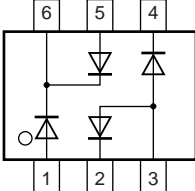
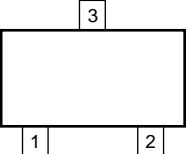
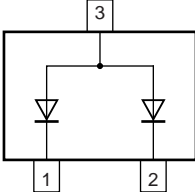
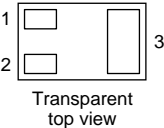
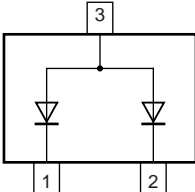
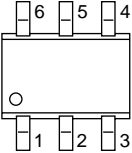
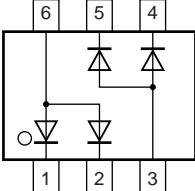
Pin	Description	Simplified outline	Symbol
<b>BAV756S</b>			
1	anode (diode 1)		
2	cathode (diode 2)		
3	common anode (diode 2 and diode 3)		
4	cathode (diode 3)		
5	anode (diode 4)		
6	common cathode (diode 1 and diode 4)		
<b>BAW56; BAW56T; BAW56W</b>			
1	cathode (diode 1)		
2	cathode (diode 2)		
3	common anode		
<b>BAW56M</b>			
1	cathode (diode 1)	 <p>Transparent top view</p>	
2	cathode (diode 2)		
3	common anode		
<b>BAW56S</b>			
1	cathode (diode 1)		
2	cathode (diode 2)		
3	common anode (diode 3 and diode 4)		
4	cathode (diode 3)		
5	cathode (diode 4)		
6	common anode (diode 1 and diode 2)		

### 3. Ordering information

Table 4. Ordering information

Type number	Package		Version
	Name	Description	
BAV756S	SC-88	plastic surface-mounted package; 6 leads	SOT363
BAW56	-	plastic surface-mounted package; 3 leads	SOT23
BAW56M	SC-101	leadless ultra small plastic package; 3 solder lands; body 1.0 × 0.6 × 0.5 mm	SOT883
BAW56S	SC-88	plastic surface-mounted package; 6 leads	SOT363
BAW56T	SC-75	plastic surface-mounted package; 3 leads	SOT416
BAW56W	SC-70	plastic surface-mounted package; 3 leads	SOT323

### 4. Marking

Table 5. Marking codes

Type number	Marking code <sup>[1]</sup>
BAV756S	A7*
BAW56	A1*
BAW56M	S5
BAW56S	A1*
BAW56T	A1
BAW56W	A1*

- [1] \* = -: made in Hong Kong  
 \* = p: made in Hong Kong  
 \* = t: made in Malaysia  
 \* = W: made in China

### 5. Limiting values

Table 6. Limiting values

In accordance with the Absolute Maximum Rating System (IEC 60134).

Symbol	Parameter	Conditions	Min	Max	Unit
<b>Per diode</b>					
$V_{RRM}$	repetitive peak reverse voltage		-	90	V
$V_R$	reverse voltage		-	90	V
$I_F$	forward current				
	BAV756S	$T_s = 60\text{ °C}$	-	250	mA
	BAW56	$T_{amb} \leq 25\text{ °C}$	-	215	mA
	BAW56M	$T_{amb} \leq 25\text{ °C}$	-	150	mA
	BAW56S	$T_s = 60\text{ °C}$	-	250	mA
	BAW56T	$T_s = 90\text{ °C}$	-	150	mA
	BAW56W	$T_{amb} \leq 25\text{ °C}$	-	150	mA

**Table 6. Limiting values ...continued**

In accordance with the Absolute Maximum Rating System (IEC 60134).

Symbol	Parameter	Conditions	Min	Max	Unit
$I_{FRM}$	repetitive peak forward current		-	500	mA
$I_{FSM}$	non-repetitive peak forward current	square wave	[1]		
		$t_p = 1 \mu s$	-	4	A
		$t_p = 1 ms$	-	1	A
		$t_p = 1 s$	-	0.5	A
$P_{tot}$	total power dissipation		[2]		
	BAV756S	$T_s = 60 \text{ }^\circ\text{C}$	-	350	mW
	BAW56	$T_{amb} \leq 25 \text{ }^\circ\text{C}$	-	250	mW
	BAW56M	$T_{amb} \leq 25 \text{ }^\circ\text{C}$	[3]	250	mW
	BAW56S	$T_s = 60 \text{ }^\circ\text{C}$	-	350	mW
	BAW56T	$T_s = 90 \text{ }^\circ\text{C}$	[4]	170	mW
	BAW56W	$T_{amb} \leq 25 \text{ }^\circ\text{C}$	-	200	mW
<b>Per device</b>					
$I_F$	forward current				
	BAV756S	$T_s = 60 \text{ }^\circ\text{C}$	-	100	mA
	BAW56	$T_{amb} \leq 25 \text{ }^\circ\text{C}$	-	125	mA
	BAW56M	$T_{amb} \leq 25 \text{ }^\circ\text{C}$	-	75	mA
	BAW56S	$T_s = 60 \text{ }^\circ\text{C}$	-	100	mA
	BAW56T	$T_s = 90 \text{ }^\circ\text{C}$	-	75	mA
	BAW56W	$T_{amb} \leq 25 \text{ }^\circ\text{C}$	-	130	mA
$T_j$	junction temperature		-	150	$^\circ\text{C}$
$T_{amb}$	ambient temperature		-65	+150	$^\circ\text{C}$
$T_{stg}$	storage temperature		-65	+150	$^\circ\text{C}$

[1]  $T_j = 25 \text{ }^\circ\text{C}$  prior to surge.

[2] Device mounted on an FR4 Printed-Circuit Board (PCB), single-sided copper, tin-plated and standard footprint.

[3] Reflow soldering is the only recommended soldering method.

[4] Single diode loaded.

## 6. Thermal characteristics

**Table 7. Thermal characteristics**

Symbol	Parameter	Conditions	Min	Typ	Max	Unit
<b>Per diode</b>						
$R_{th(j-a)}$	thermal resistance from junction to ambient	in free air	[1]			
	BAW56		-	-	500	K/W
	BAW56M		[2]	-	500	K/W
	BAW56W		-	-	625	K/W

**Table 7. Thermal characteristics ...continued**

Symbol	Parameter	Conditions	Min	Typ	Max	Unit
$R_{th(j-sp)}$	thermal resistance from junction to solder point					
	BAV756S		-	-	255	K/W
	BAW56		-	-	360	K/W
	BAW56S		-	-	255	K/W
	BAW56T		-	-	350	K/W
	BAW56W		-	-	300	K/W

[1] Device mounted on an FR4 PCB, single-sided copper, tin-plated and standard footprint.

[2] Reflow soldering is the only recommended soldering method.

## 7. Characteristics

**Table 8. Characteristics**

$T_{amb} = 25\text{ }^{\circ}\text{C}$  unless otherwise specified.

Symbol	Parameter	Conditions	Min	Typ	Max	Unit
<b>Per diode</b>						
$V_F$	forward voltage					[1]
		$I_F = 1\text{ mA}$	-	-	715	mV
		$I_F = 10\text{ mA}$	-	-	855	mV
		$I_F = 50\text{ mA}$	-	-	1	V
		$I_F = 150\text{ mA}$	-	-	1.25	V
$I_R$	reverse current	$V_R = 25\text{ V}$	-	-	30	nA
		$V_R = 80\text{ V}$	-	-	0.5	$\mu\text{A}$
		$V_R = 25\text{ V}; T_j = 150\text{ }^{\circ}\text{C}$	-	-	30	$\mu\text{A}$
		$V_R = 80\text{ V}; T_j = 150\text{ }^{\circ}\text{C}$	-	-	150	$\mu\text{A}$
$C_d$	diode capacitance	$V_R = 0\text{ V}; f = 1\text{ MHz}$	-	-	2	pF
$t_{rr}$	reverse recovery time		[2]	-	4	ns
$V_{FR}$	forward recovery voltage		[3]	-	1.75	V

[1] Pulse test:  $t_p \leq 300\text{ }\mu\text{s}; \delta \leq 0.02$ .

[2] When switched from  $I_F = 10\text{ mA}$  to  $I_R = 10\text{ mA}; R_L = 100\text{ }\Omega$ ; measured at  $I_R = 1\text{ mA}$ .

[3] When switched from  $I_F = 10\text{ mA}; t_r = 20\text{ ns}$ .

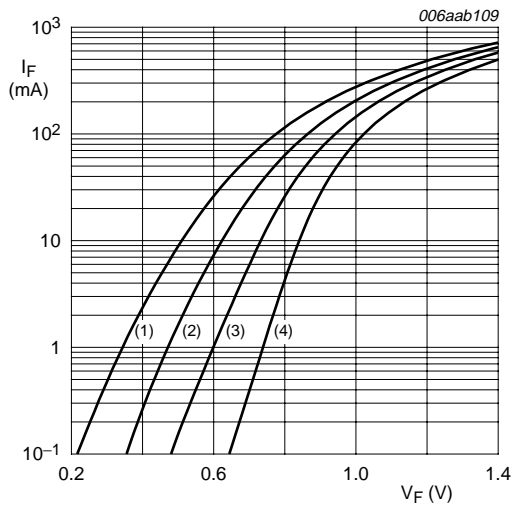

- (1)  $T_{\text{amb}} = 150^\circ\text{C}$
- (2)  $T_{\text{amb}} = 85^\circ\text{C}$
- (3)  $T_{\text{amb}} = 25^\circ\text{C}$
- (4)  $T_{\text{amb}} = -40^\circ\text{C}$

Fig 1. Forward current as a function of forward voltage; typical values

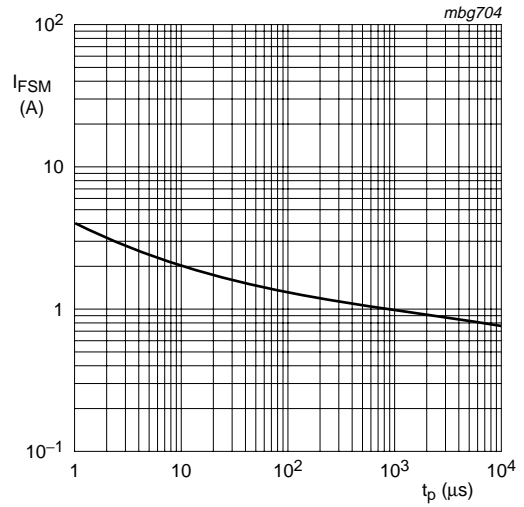

Based on square wave currents.  
 $T_j = 25^\circ\text{C}$ ; prior to surge

Fig 2. Non-repetitive peak forward current as a function of pulse duration; maximum values

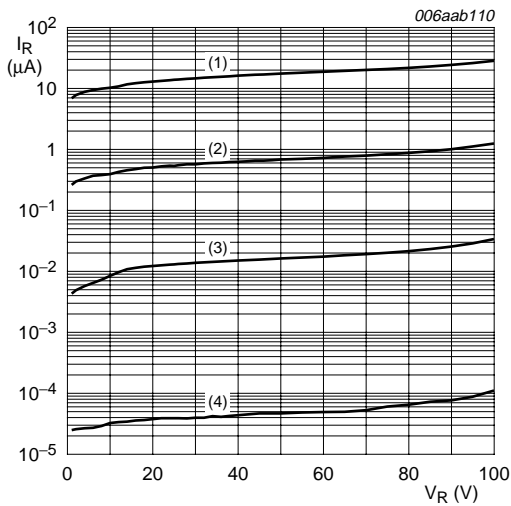

- (1)  $T_{\text{amb}} = 150^\circ\text{C}$
- (2)  $T_{\text{amb}} = 85^\circ\text{C}$
- (3)  $T_{\text{amb}} = 25^\circ\text{C}$
- (4)  $T_{\text{amb}} = -40^\circ\text{C}$

Fig 3. Reverse current as a function of reverse voltage; typical values

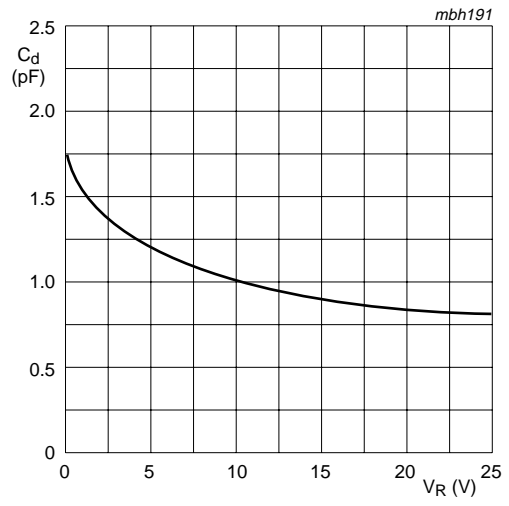

$f = 1\text{ MHz}$ ;  $T_{\text{amb}} = 25^\circ\text{C}$

Fig 4. Diode capacitance as a function of reverse voltage; typical values

8. Test information

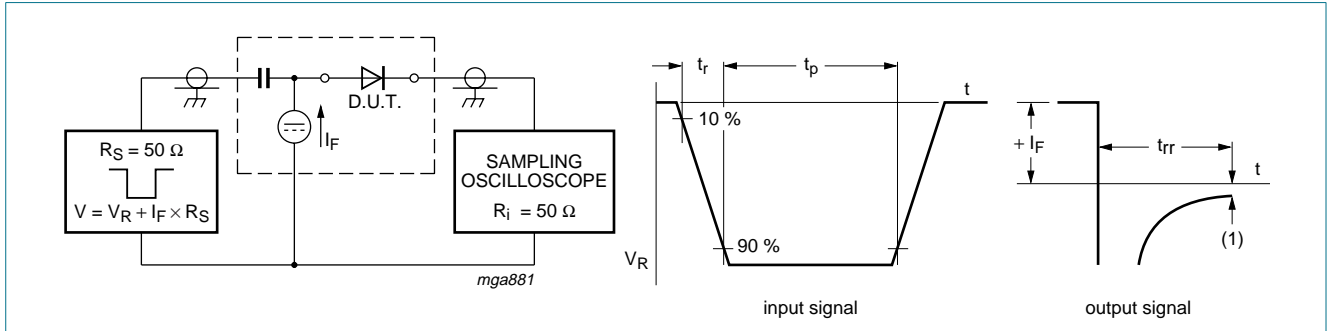

(1)  $I_R = 1 \text{ mA}$

Input signal: reverse pulse rise time  $t_r = 0.6 \text{ ns}$ ; reverse voltage pulse duration  $t_p = 100 \text{ ns}$ ; duty cycle  $\delta = 0.05$

Oscilloscope: rise time  $t_r = 0.35 \text{ ns}$

Fig 5. Reverse recovery time test circuit and waveforms

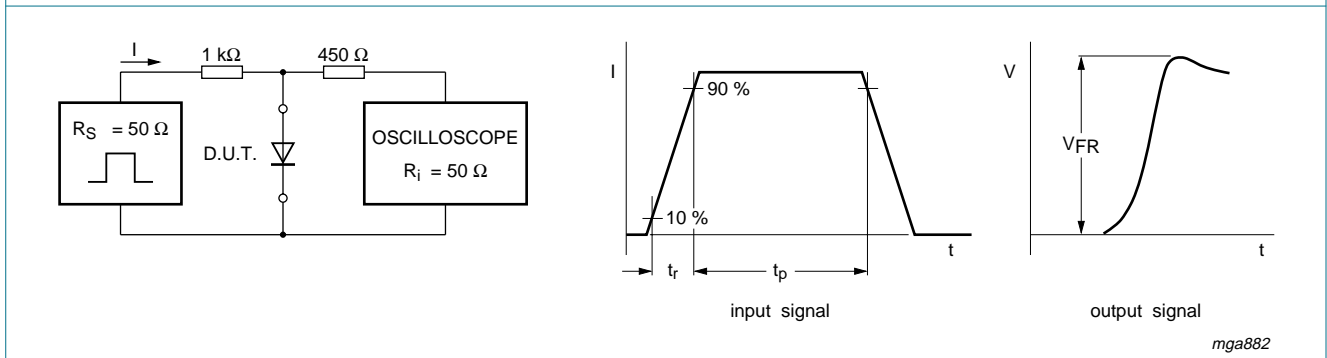

Input signal: forward pulse rise time  $t_r = 20 \text{ ns}$ ; forward current pulse duration  $t_p \geq 100 \text{ ns}$ ; duty cycle  $\delta \leq 0.005$

Fig 6. Forward recovery voltage test circuit and waveforms

**9. Package outline**

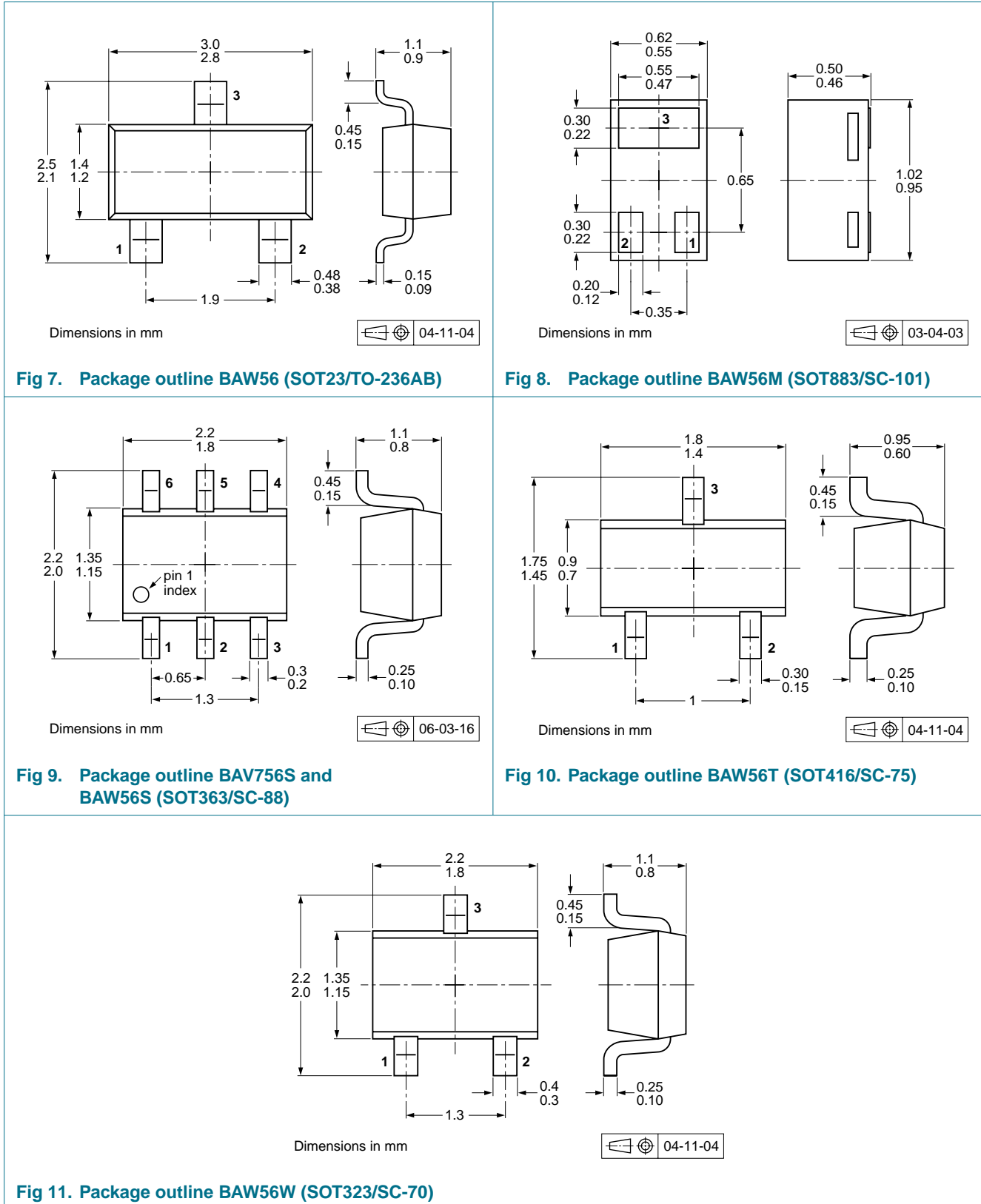



## 10. Packing information

**Table 9. Packing methods**

The indicated -xxx are the last three digits of the 12NC ordering code.<sup>[1]</sup>

Type number	Package	Description	Packing quantity	
			3000	10000
BAV756S	SOT363	4 mm pitch, 8 mm tape and reel; T1	[2] -115	-135
		4 mm pitch, 8 mm tape and reel; T2	[3] -125	-165
BAW56	SOT23	4 mm pitch, 8 mm tape and reel	-215	-235
BAW56M	SOT883	2 mm pitch, 8 mm tape and reel	-	-315
BAW56S	SOT363	4 mm pitch, 8 mm tape and reel; T1	[2] -115	-135
		4 mm pitch, 8 mm tape and reel; T2	[3] -125	-165
BAW56T	SOT416	4 mm pitch, 8 mm tape and reel	-115	-135
BAW56W	SOT323	4 mm pitch, 8 mm tape and reel	-115	-135

[1] For further information and the availability of packing methods, see [Section 14](#).

[2] T1: normal taping

[3] T2: reverse taping

## 11. Soldering

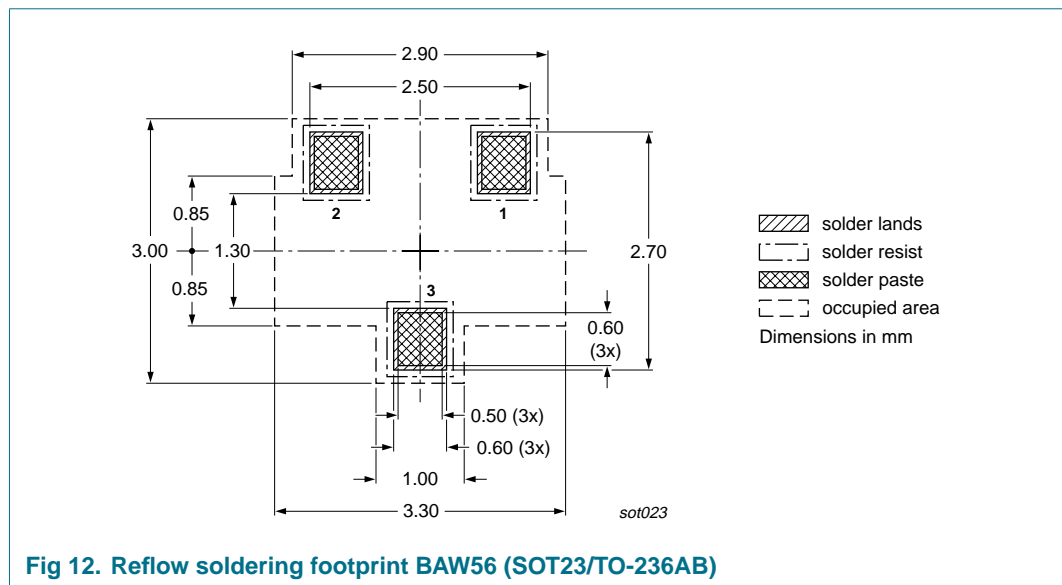

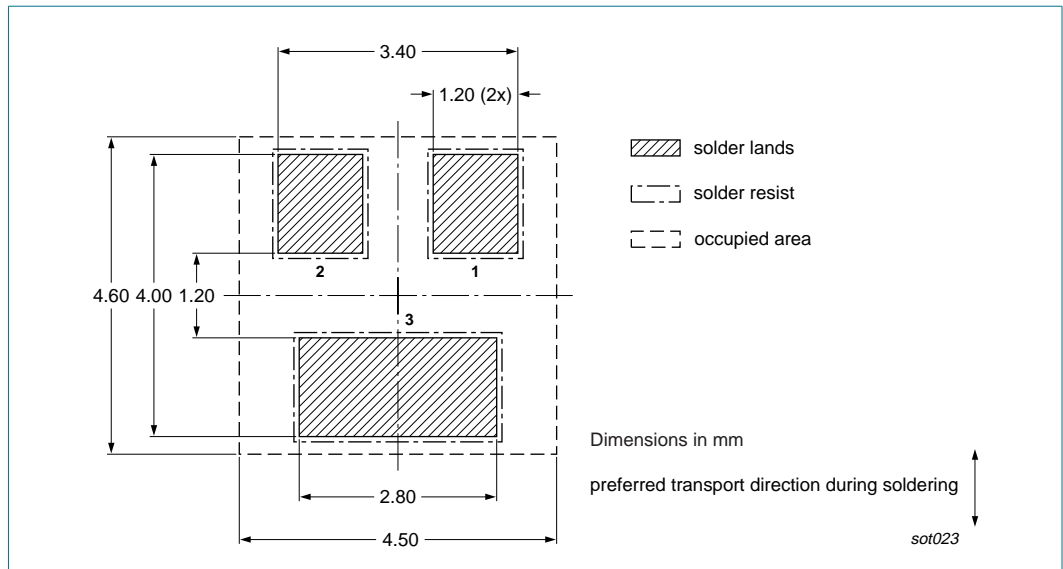

**Fig 13. Wave soldering footprint BAW56 (SOT23/TO-236AB)**

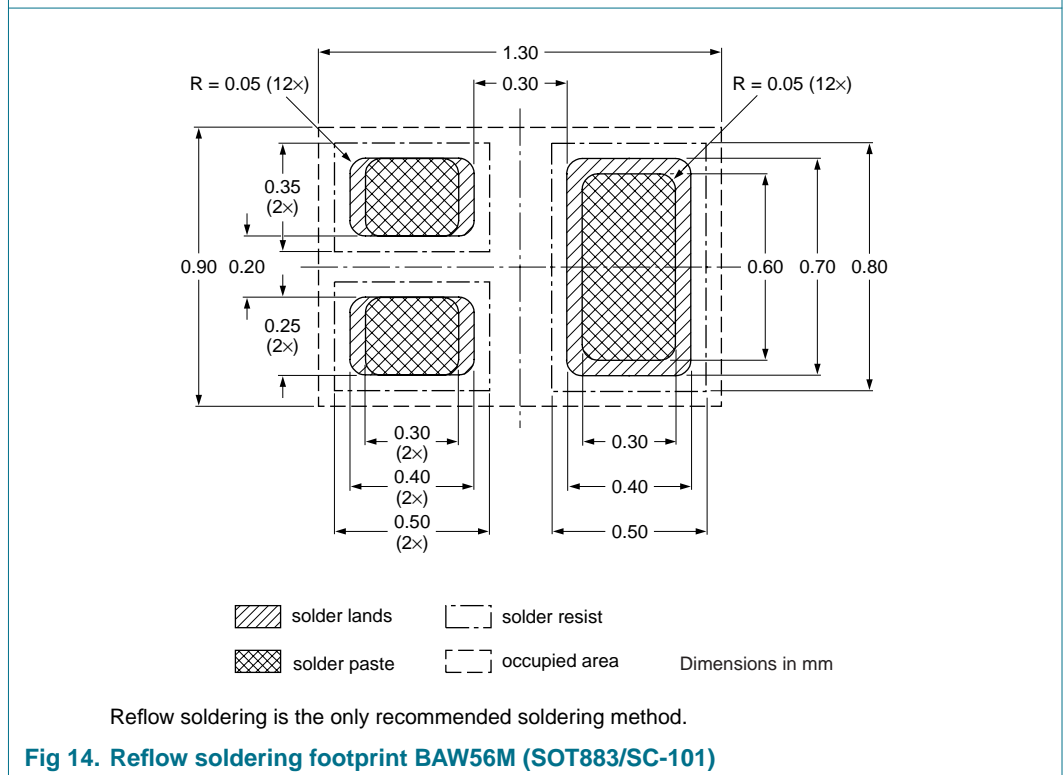

**Fig 14. Reflow soldering footprint BAW56M (SOT883/SC-101)**

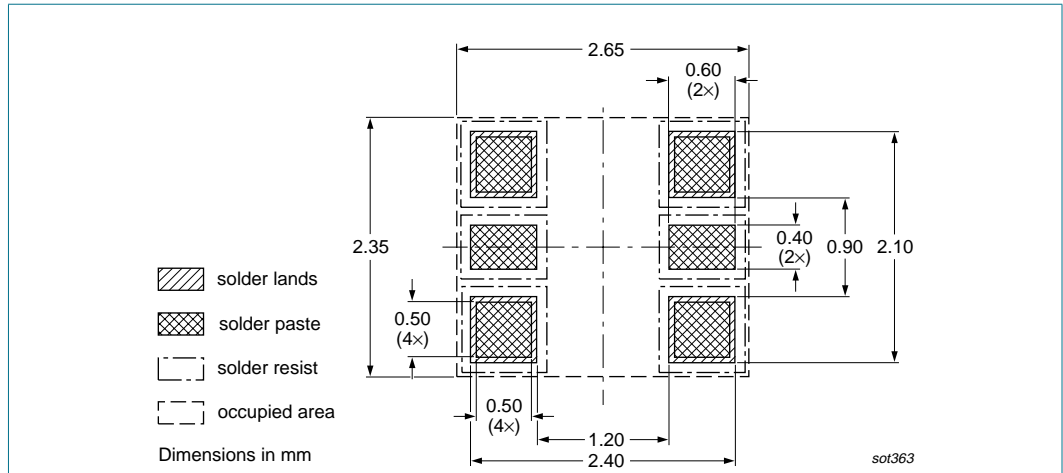

Fig 15. Reflow soldering footprint BAV756S and BAW56S (SOT363/SC-88)

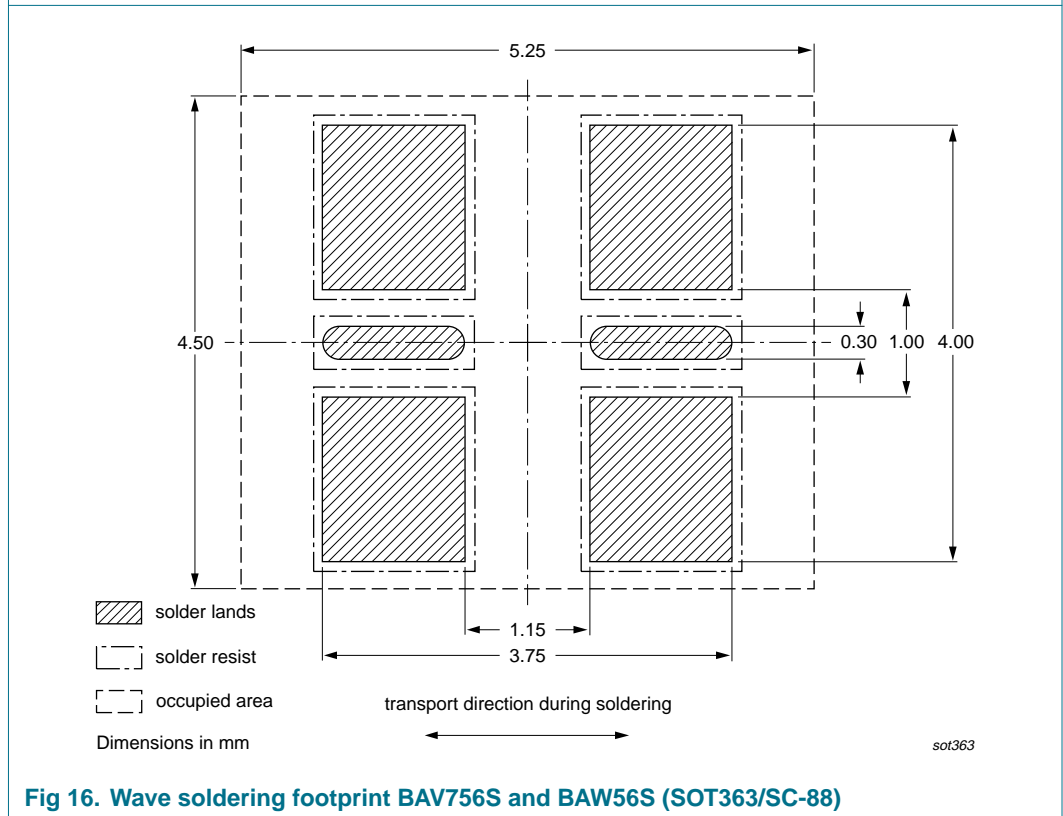

Fig 16. Wave soldering footprint BAV756S and BAW56S (SOT363/SC-88)

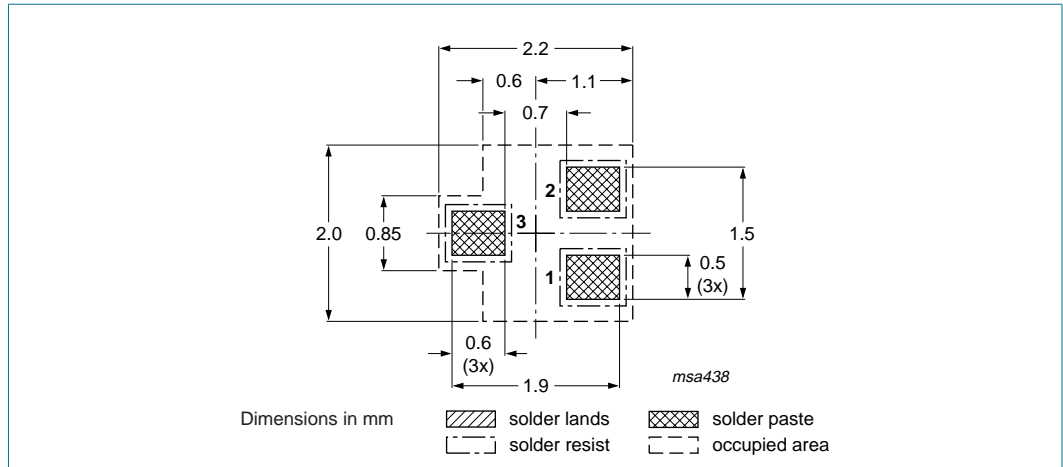

Fig 17. Reflow soldering footprint BAW56T (SOT416/SC-75)

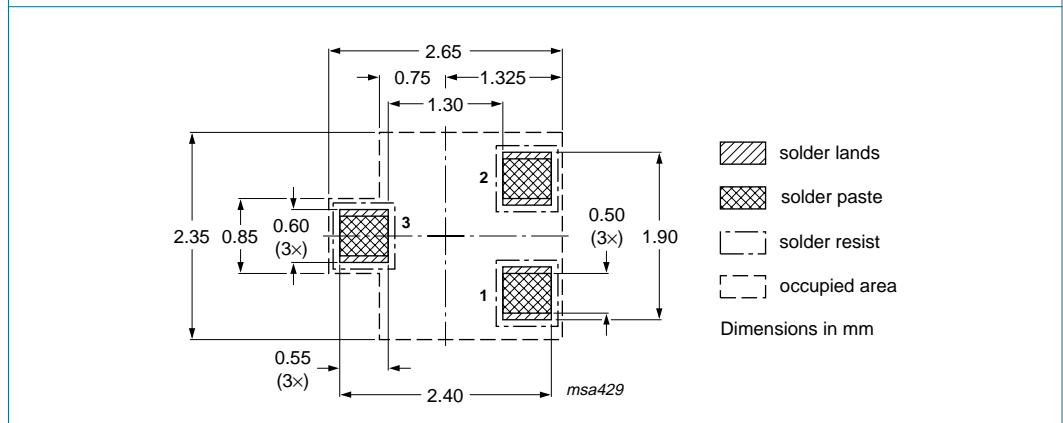

Fig 18. Reflow soldering footprint BAW56W (SOT323/SC-70)

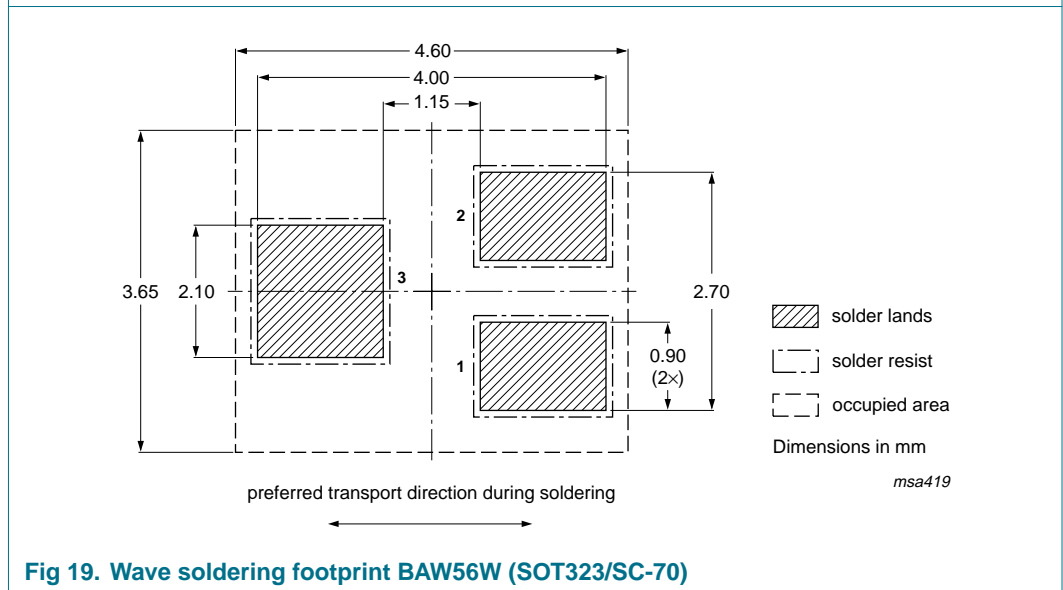

Fig 19. Wave soldering footprint BAW56W (SOT323/SC-70)

## 12. Revision history

**Table 10. Revision history**

Document ID	Release date	Data sheet status	Change notice	Supersedes
BAV756S_BAW56_SER_5	20071126	Product data sheet	-	BAV756S_2 BAW56_4 BAW56S_2 BAW56T_2 BAW56W_4
<p>Modifications:</p> <ul style="list-style-type: none"> <li>• The format of this data sheet has been redesigned to comply with the new identity guidelines of NXP Semiconductors.</li> <li>• Legal texts have been adapted to the new company name where appropriate.</li> <li>• Type number BAW56M added</li> <li>• <a href="#">Section 1.1 “General description”</a>: amended</li> <li>• <a href="#">Table 1 “Product overview”</a>: added</li> <li>• <a href="#">Table 2 “Quick reference data”</a>: added</li> <li>• <a href="#">Table 6 “Limiting values”</a>: for BAV756S, BAW56, BAW56S, BAW56T and BAW56W change of <math>V_{RRM}</math> maximum value from 85 V to 90 V</li> <li>• <a href="#">Table 6 “Limiting values”</a>: for BAV756S, BAW56, BAW56S, BAW56T and BAW56W change of <math>V_R</math> maximum value from 75 V to 90 V</li> <li>• <a href="#">Table 8 “Characteristics”</a>: for BAV756S, BAW56, BAW56S, BAW56T and BAW56W change of <math>I_R</math> condition <math>V_R</math> from 75 V to 80 V for <math>T_j = 25\text{ °C}</math></li> <li>• <a href="#">Table 8 “Characteristics”</a>: for BAV756S change of <math>I_R</math> maximum value from 2.5 <math>\mu\text{A}</math> to 0.5 <math>\mu\text{A}</math> for <math>T_j = 25\text{ °C}</math></li> <li>• <a href="#">Table 8 “Characteristics”</a>: for BAW56, BAW56S, BAW56T and BAW56W change of <math>I_R</math> maximum value from 1 <math>\mu\text{A}</math> to 0.5 <math>\mu\text{A}</math> for <math>T_j = 25\text{ °C}</math></li> <li>• <a href="#">Table 8 “Characteristics”</a>: for BAV756S, BAW56, BAW56S, BAW56T and BAW56W change of <math>I_R</math> condition <math>V_R</math> from 75 V to 80 V for <math>T_j = 150\text{ °C}</math></li> <li>• <a href="#">Table 8 “Characteristics”</a>: for BAV756S change of <math>I_R</math> maximum value from 60 <math>\mu\text{A}</math> to 30 <math>\mu\text{A}</math> for <math>I_R</math> condition <math>V_R = 25\text{ V}</math>; <math>T_j = 150\text{ °C}</math></li> <li>• <a href="#">Table 8 “Characteristics”</a>: for BAV756S change of <math>I_R</math> maximum value from 100 <math>\mu\text{A}</math> to 150 <math>\mu\text{A}</math> for <math>T_j = 150\text{ °C}</math></li> <li>• <a href="#">Table 8 “Characteristics”</a>: for BAW56, BAW56S, BAW56T and BAW56W change of <math>I_R</math> maximum value from 50 <math>\mu\text{A}</math> to 150 <math>\mu\text{A}</math> for <math>T_j = 150\text{ °C}</math></li> <li>• <a href="#">Section 8 “Test information”</a>: added</li> <li>• <a href="#">Section 10 “Packing information”</a>: added</li> <li>• <a href="#">Section 11 “Soldering”</a>: added</li> <li>• <a href="#">Section 13 “Legal information”</a>: updated</li> </ul>				
BAV756S_2	19971021	Product specification	-	BAV756S_1
BAW56_4	20030325	Product specification	-	BAW56_3
BAW56S_2	19971021	Product specification	-	BAW56S_1
BAW56T_2	19971219	Product specification	-	-
BAW56W_4	19990511	Product specification	-	BAW56W_3

## 13. Legal information

### 13.1 Data sheet status

Document status <sup>[1][2]</sup>	Product status <sup>[3]</sup>	Definition
Objective [short] data sheet	Development	This document contains data from the objective specification for product development.
Preliminary [short] data sheet	Qualification	This document contains data from the preliminary specification.
Product [short] data sheet	Production	This document contains the product specification.

[1] Please consult the most recently issued document before initiating or completing a design.

[2] The term 'short data sheet' is explained in section "Definitions".

[3] The product status of device(s) described in this document may have changed since this document was published and may differ in case of multiple devices. The latest product status information is available on the Internet at URL <http://www.nxp.com>.

### 13.2 Definitions

**Draft** — The document is a draft version only. The content is still under internal review and subject to formal approval, which may result in modifications or additions. NXP Semiconductors does not give any representations or warranties as to the accuracy or completeness of information included herein and shall have no liability for the consequences of use of such information.

**Short data sheet** — A short data sheet is an extract from a full data sheet with the same product type number(s) and title. A short data sheet is intended for quick reference only and should not be relied upon to contain detailed and full information. For detailed and full information see the relevant full data sheet, which is available on request via the local NXP Semiconductors sales office. In case of any inconsistency or conflict with the short data sheet, the full data sheet shall prevail.

### 13.3 Disclaimers

**General** — Information in this document is believed to be accurate and reliable. However, NXP Semiconductors does not give any representations or warranties, expressed or implied, as to the accuracy or completeness of such information and shall have no liability for the consequences of use of such information.

**Right to make changes** — NXP Semiconductors reserves the right to make changes to information published in this document, including without limitation specifications and product descriptions, at any time and without notice. This document supersedes and replaces all information supplied prior to the publication hereof.

**Suitability for use** — NXP Semiconductors products are not designed, authorized or warranted to be suitable for use in medical, military, aircraft, space or life support equipment, nor in applications where failure or

malfunction of an NXP Semiconductors product can reasonably be expected to result in personal injury, death or severe property or environmental damage. NXP Semiconductors accepts no liability for inclusion and/or use of NXP Semiconductors products in such equipment or applications and therefore such inclusion and/or use is at the customer's own risk.

**Applications** — Applications that are described herein for any of these products are for illustrative purposes only. NXP Semiconductors makes no representation or warranty that such applications will be suitable for the specified use without further testing or modification.

**Limiting values** — Stress above one or more limiting values (as defined in the Absolute Maximum Ratings System of IEC 60134) may cause permanent damage to the device. Limiting values are stress ratings only and operation of the device at these or any other conditions above those given in the Characteristics sections of this document is not implied. Exposure to limiting values for extended periods may affect device reliability.

**Terms and conditions of sale** — NXP Semiconductors products are sold subject to the general terms and conditions of commercial sale, as published at <http://www.nxp.com/profile/terms>, including those pertaining to warranty, intellectual property rights infringement and limitation of liability, unless explicitly otherwise agreed to in writing by NXP Semiconductors. In case of any inconsistency or conflict between information in this document and such terms and conditions, the latter will prevail.

**No offer to sell or license** — Nothing in this document may be interpreted or construed as an offer to sell products that is open for acceptance or the grant, conveyance or implication of any license under any copyrights, patents or other industrial or intellectual property rights.

### 13.4 Trademarks

Notice: All referenced brands, product names, service names and trademarks are the property of their respective owners.

## 14. Contact information

For additional information, please visit: <http://www.nxp.com>

For sales office addresses, send an email to: [salesaddresses@nxp.com](mailto:salesaddresses@nxp.com)

## 15. Contents

<b>1</b>	<b>Product profile</b> .....	<b>1</b>
1.1	General description .....	1
1.2	Features .....	1
1.3	Applications .....	1
1.4	Quick reference data .....	1
<b>2</b>	<b>Pinning information</b> .....	<b>2</b>
<b>3</b>	<b>Ordering information</b> .....	<b>3</b>
<b>4</b>	<b>Marking</b> .....	<b>3</b>
<b>5</b>	<b>Limiting values</b> .....	<b>3</b>
<b>6</b>	<b>Thermal characteristics</b> .....	<b>4</b>
<b>7</b>	<b>Characteristics</b> .....	<b>5</b>
<b>8</b>	<b>Test information</b> .....	<b>7</b>
<b>9</b>	<b>Package outline</b> .....	<b>8</b>
<b>10</b>	<b>Packing information</b> .....	<b>9</b>
<b>11</b>	<b>Soldering</b> .....	<b>9</b>
<b>12</b>	<b>Revision history</b> .....	<b>13</b>
<b>13</b>	<b>Legal information</b> .....	<b>14</b>
13.1	Data sheet status .....	14
13.2	Definitions .....	14
13.3	Disclaimers .....	14
13.4	Trademarks .....	14
<b>14</b>	<b>Contact information</b> .....	<b>14</b>
<b>15</b>	<b>Contents</b> .....	<b>15</b>

Please be aware that important notices concerning this document and the product(s) described herein, have been included in section 'Legal information'.



© NXP B.V. 2007.

All rights reserved.

For more information, please visit: <http://www.nxp.com>

For sales office addresses, please send an email to: [salesaddresses@nxp.com](mailto:salesaddresses@nxp.com)

Date of release: 26 November 2007

Document identifier: BAV756S\_BAW56\_SER\_5