

# International IOR Rectifier

## 150EBU04

### Ultrafast Soft Recovery Diode

#### Features

- Ultrafast Recovery
- 175°C Operating Junction Temperature
- Screw Mounting Only
- Lead-Free Plating

#### Benefits

- Reduced RFI and EMI
- Higher Frequency Operation
- Reduced Snubbing
- Reduced Parts Count

$$t_{rr} = 60\text{ns}$$

$$I_{F(AV)} = 150\text{Amp}$$

$$V_R = 400\text{V}$$

#### Description/ Applications

These diodes are optimized to reduce losses and EMI/ RFI in high frequency power conditioning systems. The softness of the recovery eliminates the need for a snubber in most applications. These devices are ideally suited for HF welding, power converters and other applications where switching losses are not significant portion of the total losses.

#### Absolute Maximum Ratings

Parameters	Max	Units
$V_R$ Cathode to Anode Voltage	400	V
$I_{F(AV)}$ Continuous Forward Current, $T_C = 104^\circ\text{C}$	150	A
$I_{FSM}$ Single Pulse Forward Current, $T_C = 25^\circ\text{C}$	1500	
$I_{FRM} \text{ } \textcircled{1}$ Maximum Repetitive Forward Current	300	
$T_J, T_{STG}$ Operating Junction and Storage Temperatures	- 55 to 175	$^\circ\text{C}$

$\textcircled{1}$  Square Wave, 20kHz

#### Case Styles

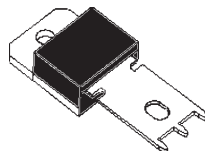

Pow $I$ Rtab

**Electrical Characteristics @ T<sub>J</sub> = 25°C (unless otherwise specified)**

Parameters	Min	Typ	Max	Units	Test Conditions
V <sub>BR</sub> , V <sub>r</sub> Breakdown Voltage, Blocking Voltage	400	-	-	V	I <sub>R</sub> = 200μA
V <sub>F</sub> Forward Voltage	-	1.07	1.3	V	I <sub>F</sub> = 150A
	-	0.9	1.1	V	I <sub>F</sub> = 150A, T <sub>J</sub> = 175°C
	-	0.96	1.17	V	I <sub>F</sub> = 150A, T <sub>J</sub> = 125°C
I <sub>R</sub> Reverse Leakage Current	-	-	50	μA	V <sub>R</sub> = V <sub>R</sub> Rated
	-	-	4	mA	T <sub>J</sub> = 150°C, V <sub>R</sub> = V <sub>R</sub> Rated
C <sub>T</sub> Junction Capacitance	-	100	-	pF	V <sub>R</sub> = 400V
L <sub>S</sub> Series Inductance	-	3.5	-	nH	Measured lead to lead 5mm from package body

**Dynamic Recovery Characteristics @ T<sub>J</sub> = 25°C (unless otherwise specified)**

Parameters	Min	Typ	Max	Units	Test Conditions	
t <sub>rr</sub> Reverse Recovery Time	-	-	60	ns	I <sub>F</sub> = 1.0A, di <sub>F</sub> /dt = 200A/μs, V <sub>R</sub> = 30V I <sub>F</sub> = 150A V <sub>R</sub> = 200V di <sub>F</sub> /dt = 200A/μs	
	-	93	-			T <sub>J</sub> = 25°C
	-	172	-			T <sub>J</sub> = 125°C
I <sub>R</sub> Peak Recovery Current	-	11	-	A	T <sub>J</sub> = 25°C T <sub>J</sub> = 125°C	
	-	20	-			
Q <sub>rr</sub> Reverse Recovery Charge	-	490	-	nC	T <sub>J</sub> = 25°C T <sub>J</sub> = 125°C	
	-	-	1740			

**Thermal - Mechanical Characteristics**

Parameters	Min	Typ	Max	Units
R <sub>thJC</sub> Thermal Resistance, Junction to Case			0.35	K/W
R <sub>thCS</sub> ② Thermal Resistance, Case to Heatsink		0.2		
Wt Weight			5.02	g
			0.18	(oz)
T Mounting Torque	1.2		2.4	N * m
	10		20	lbf.in

② Mounting Surface, Flat, Smooth and Greased

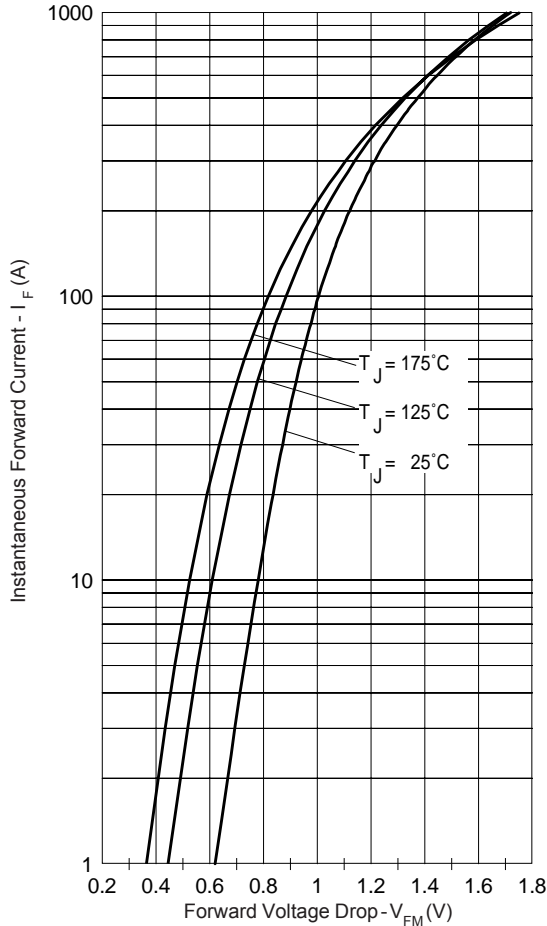

Fig. 1 - Typical Forward Voltage Drop Characteristics

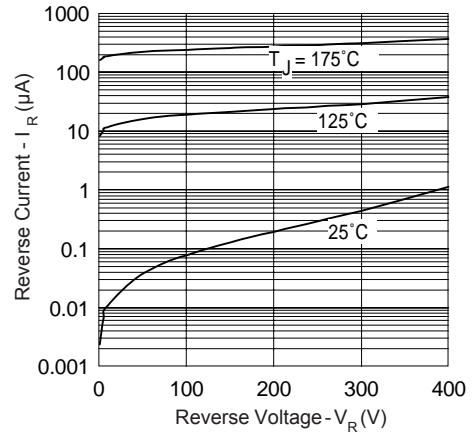

Fig. 2 - Typical Values Of Reverse Current Vs. Reverse Voltage

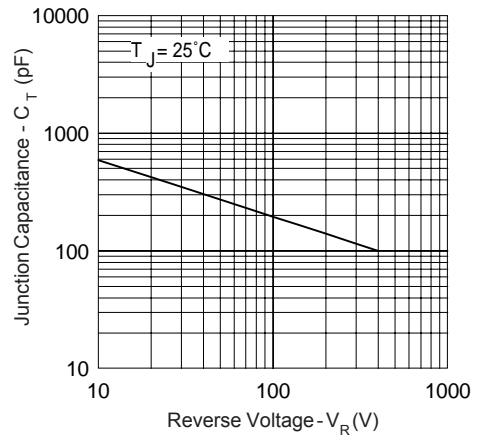

Fig. 3 - Typical Junction Capacitance Vs. Reverse Voltage

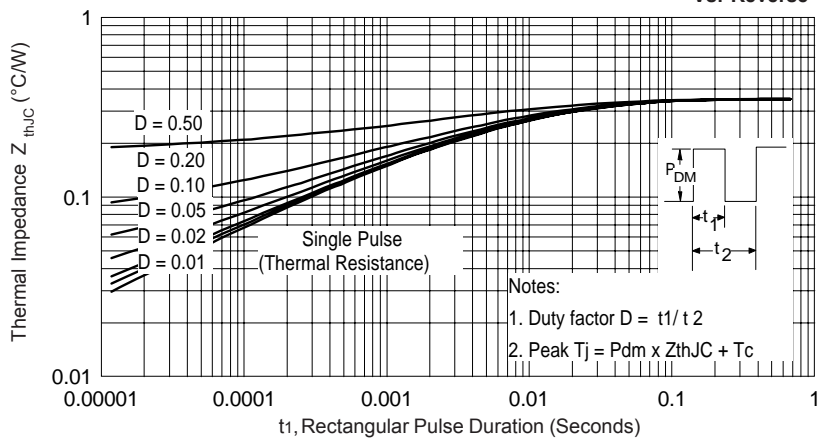

Fig. 4 - Max. Thermal Impedance  $Z_{thJC}$  Characteristics

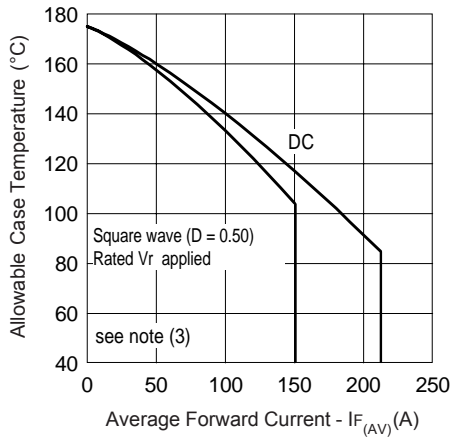

Fig. 5 - Max. Allowable Case Temperature Vs. Average Forward Current

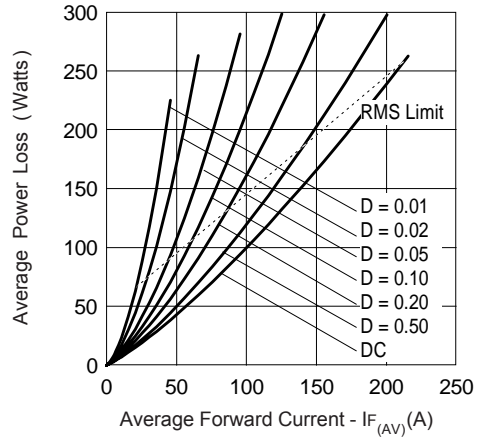

Fig. 6 - Forward Power Loss Characteristics

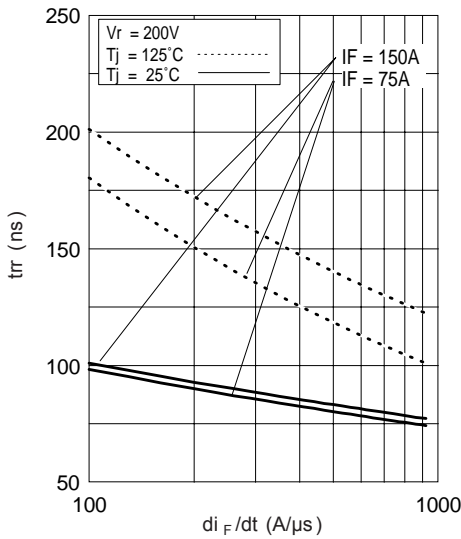

Fig. 7 - Typical Reverse Recovery time vs.  $di_F/dt$

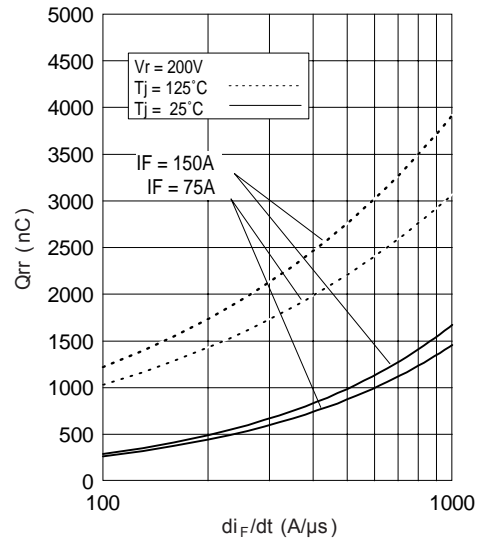

Fig. 8 - Typical Stored Charge vs.  $di_F/dt$

(3) Formula used:  $T_c = T_j - (Pd + Pd_{REV}) \times R_{thJC}$ ;

$Pd$  = Forward Power Loss =  $I_{F(AV)} \times V_{FM} @ (I_{F(AV)} / D)$  (see Fig. 6);

$Pd_{REV}$  = Inverse Power Loss =  $V_{R1} \times I_R (1 - D)$ ;  $I_R @ V_{R1}$  = rated  $V_R$

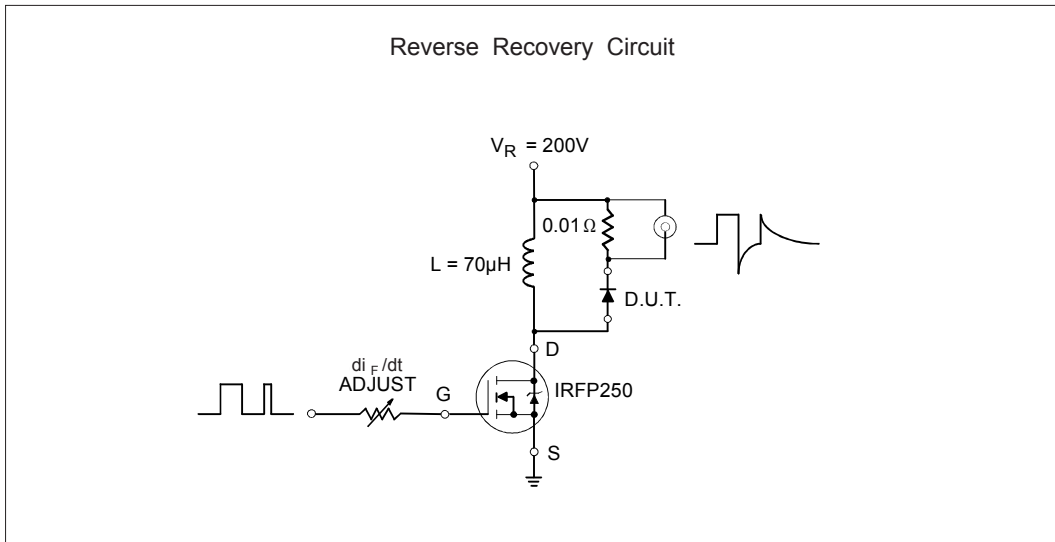

Fig. 9- Reverse Recovery Parameter Test Circuit

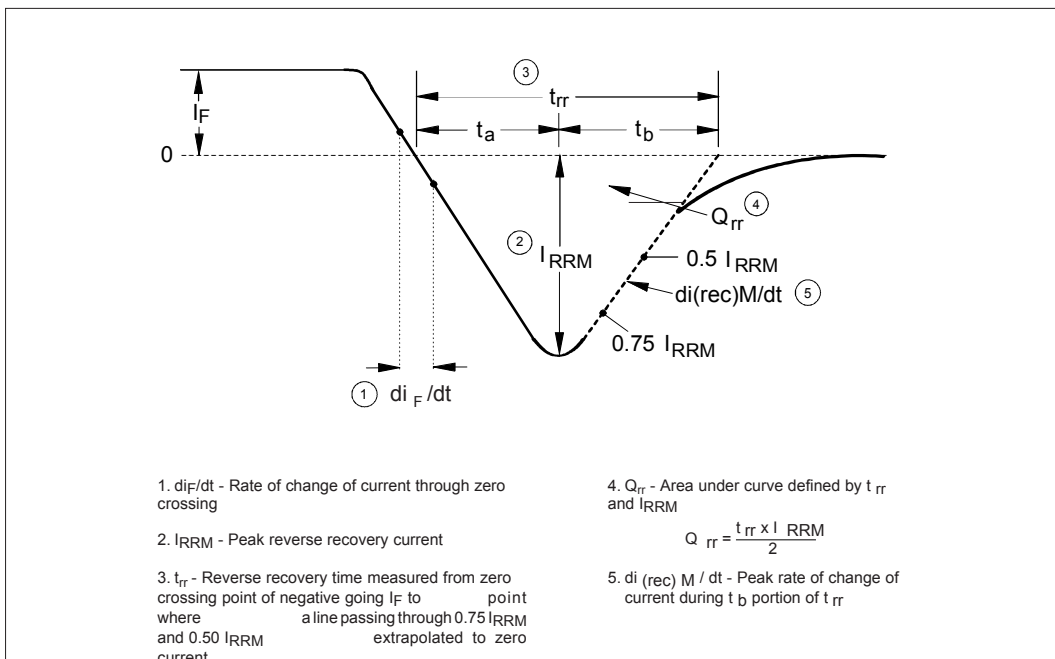
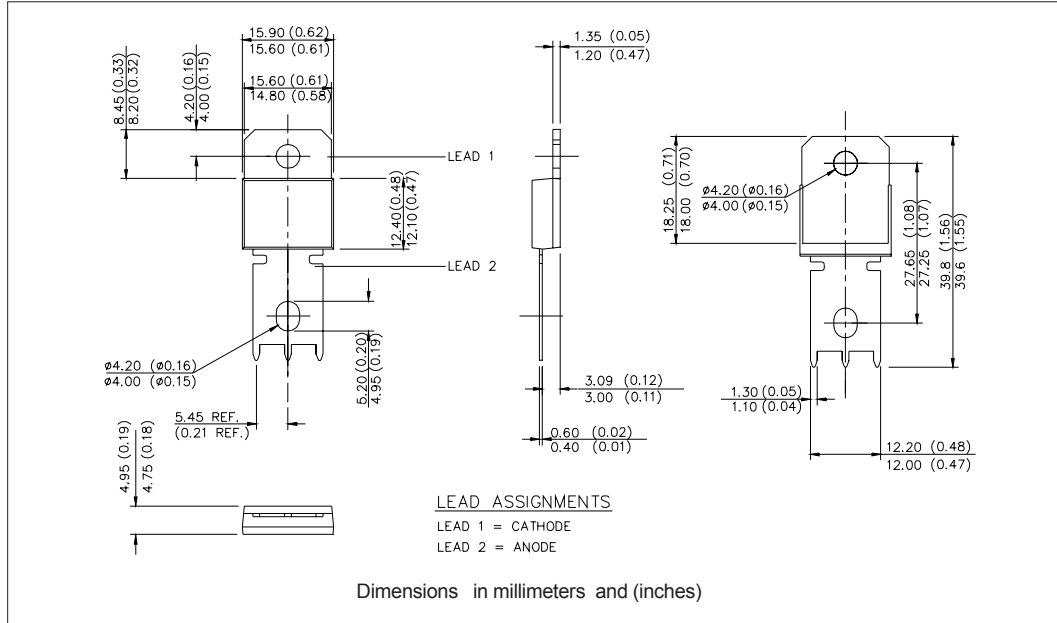

Fig. 10 - Reverse Recovery Waveform and Definitions

Outline Table



Ordering Information Table

Device Code	
<b>150</b>	<b>E B U 04</b>
①	② ③ ④ ⑤
<b>1</b>	- Current Rating (150 = 150A)
<b>2</b>	- Single Diode
<b>3</b>	- PowIRtab (Ultrafast/ Hyperfast only)
<b>4</b>	- Ultrafast Recovery
<b>5</b>	- Voltage Rating (04 = 400V)

Data and specifications subject to change without notice.  
This product has been designed and qualified for Industrial Level and Lead-Free.  
Qualification Standards can be found on IR's Web site.