

TRIL

MAIN FEATURES

- 16A switching capabilities.
- 1 & 2 pole configurations.
- 5KV/10mm dielectric coil to contacts.
- Low height of 15.7mm.
- Sealed & Unsealed types available.
- UL & cUL recognized.



APPLICATIONS

- Microwave Oven; Facsimile; Refrigerator, Air Conditioner, Stereo Equipment; Copiers, TV Set, Monitor, Vending Machine, Temperature Controller, etc.

ORDERING INFORMATION

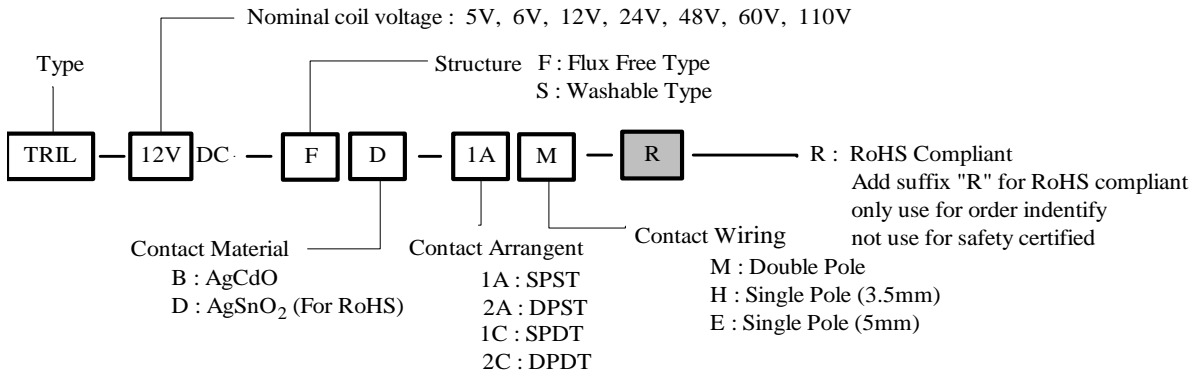

DIMENSION (unit:mm)

DRILLING (unit:mm)

WIRING DIAGRAM

5mm 2 Pole

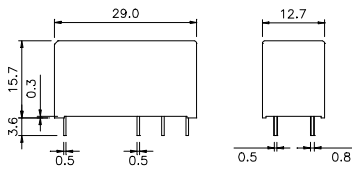

PC Board Layout

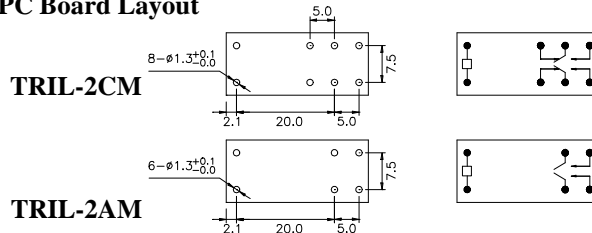

3.5mm 1 Pole

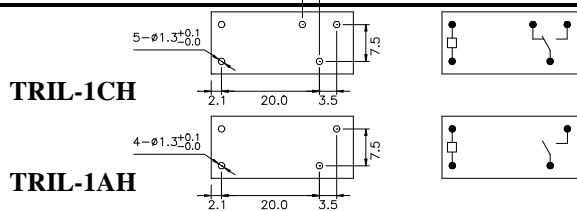
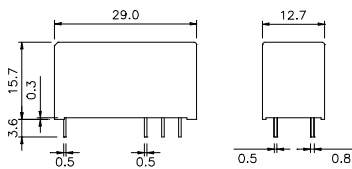

5mm 1 Pole

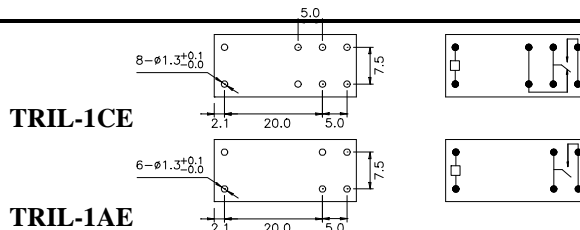
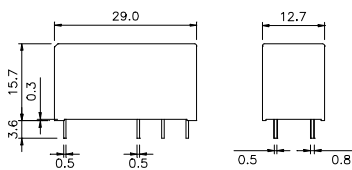

COIL DATA CHART (AT20°C)

Coil Sensitivity	Coil Voltage Code	Nominal Voltage (VDC)	Nominal Current (mA)	Coil Resistance (Ω) \pm 10%	Power Consumption (W)	Pull-In Voltage (VDC)	Drop-Out Voltage (VDC)	Max-Allowable Voltage (VDC)
TRIL	005	5	80.6	62	abt. 0.4W	70% Max.	10% Min.	110% Max.
	006	6	66.7	90				
	012	12	33.3	360				
	024	24	16.7	1440				
	048	48	8.3	5760 \pm 15%				
	060	60	8.0	7500 \pm 15%				
	110	110	4.3	25200 \pm 15%				

CONTACT RATING

Item	Type	SPST (1A) , SPDT (1C)	DPST (2A) , DPDT (2C)	
		TRIL-E	TRIL-H	TRIL-M
Contact Capacity Resistive Load (cos Φ =1)		16A 250VAC	12A 250VAC	8A 250VAC
Rated Carrying Current		16A	12A	8A
Max. Allowable Voltage		250VAC / 125VDC		
Max. Allowable Current		16A	12A	8A
Max. Allowable Power Force		4000VA/480 W	3000VA/360 W	2000VA/240W
Contact Material		Ag Alloy		

PERFORMANCE (at initial value)

Item	Type	TRIL
Contact Resistance		50m Ω Max (measured at 1A 6VDC).
Operation Time		7msec Max.
Release Time		3msec Max.
Dielectric Strength		
Between coil & contacts		5000VAC, 1min
Between open contacts		1000VAC, 1min
Between Contact sets		2500VAC, 1min
Insulation Resistance		1000 M Ω Min. (500VDC)
Operating Ambient Temperature		-40°C to +70°C
Operating Humidity		35% to 85% RH
Vibration Resistance		30 to 150HZ Double Amplitude 1.5mm
Shock Resistance		100 m/s ²
Life Expectancy		
Mechanically		1 \times 10 ⁷ ops. Min. (7200 OPS/Hour)
Electrically		1 \times 10 ⁵ ops. Min. (360 OPS/Hour)
Weight		abt. 13.5grs.
UL & cUL		E156406

REFERENCE DATA

1 Pole 12/16A

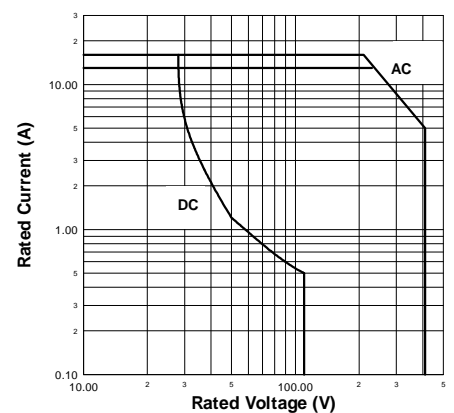

2 Pole 8A

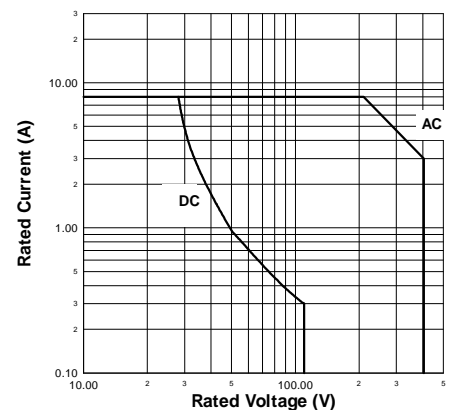

This datasheet for reference and subject to change without notice. Please double check final specification with Tai-Shing.