



20TQ...
20TQ...S

SCHOTTKY RECTIFIER

20 Amp

$I_{F(AV)} = 19\text{Amp}$
 $V_R = 35/ 45\text{V}$

Major Ratings and Characteristics



Characteristics	Values	Units
$I_{F(AV)}$ Rectangular waveform	20	A
V_{RRM} range	35/45	V
I_{FSM} @tp = 5 μ s sine	1800	A
V_F @20 Apk, $T_J = 125^\circ\text{C}$	0.51	V
T_J range	-55 to 150	$^\circ\text{C}$

Description/ Features

The 20TQ Schottky rectifier series has been optimized for very low forward voltage drop, with moderate leakage. The proprietary barrier technology allows for reliable operation up to 150° C junction temperature. Typical applications are in switching power supplies, converters, free-wheeling diodes, and reverse battery protection.

- 150° C T_J operation
- High purity, high temperature epoxy encapsulation for enhanced mechanical strength and moisture resistance
- Low forward voltage drop
- High frequency operation
- Guard ring for enhanced ruggedness and long term reliability

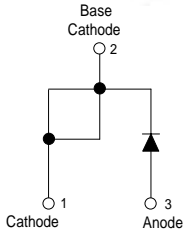
Case Styles

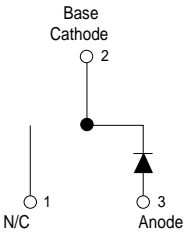
<p>20TQ...</p>  <p>Base Cathode 2</p>  <p>1 Cathode 3 Anode</p> <p>TO-220AC</p>	<p>20TQ... S</p>  <p>Base Cathode 2</p>  <p>1 N/C 3 Anode</p> <p>D²PAK</p>
-------------------------------------------------------------------------------------------------------------------------------------------------------------------------------------------------------------------------------------------------------------------	---------------------------------------------------------------------------------------------------------------------------------------------------------------------------------------------------------------------------------------------------------------------------

Voltage Ratings

Part number	20TQ035	20TQ040	20TQ045
V_R Max. DC Reverse Voltage (V)	35	40	45
V_{RWM} Max. Working Peak Reverse Voltage (V)			

Absolute Maximum Ratings

Parameters	20TQ	Units	Conditions
$I_{F(AV)}$ Max. Average Forward Current * See Fig. 5	20	A	50% duty cycle @ $T_C = 116^\circ\text{C}$, rectangular wave form
I_{FSM} Max. Peak One Cycle Non-Repetitive Surge Current * See Fig. 7	1800	A	5 μs Sine or 3 μs Rect. pulse
	400		10ms Sine or 6ms Rect. pulse
E_{AS} Non-Repetitive Avalanche Energy	27	mJ	$T_J = 25^\circ\text{C}$, $I_{AS} = 4$ Amps, $L = 3.4$ mH
I_{AR} Repetitive Avalanche Current	4	A	Current decaying linearly to zero in 1 μsec Frequency limited by T_J , max. $V_A = 1.5 \times V_R$ typical

Electrical Specifications

Parameters	20TQ	Units	Conditions
V_{FM} Max. Forward Voltage Drop (1) * See Fig. 1	0.57	V	@ 20A
	0.73	V	@ 40A
	0.51	V	@ 20A
	0.67	V	@ 40A
I_{RM} Max. Reverse Leakage Current (1) * See Fig. 2	2.7	mA	$T_J = 25^\circ\text{C}$
	105	mA	$T_J = 125^\circ\text{C}$
C_T Max. Junction Capacitance	1400	pF	$V_R = 5V_{DC}$ (test signal range 100Khz to 1Mhz) 25°C
L_S Typical Series Inductance	8.0	nH	Measured lead to lead 5mm from package body
dv/dt Max. Voltage Rate of Change (Rated V_R)	10000	V/ μs	

(1) Pulse Width < 300 μs , Duty Cycle < 2%

Thermal-Mechanical Specifications

Parameters	20TQ	Units	Conditions
T_J Max. Junction Temperature Range	-55 to 150	$^\circ\text{C}$	
T_{stg} Max. Storage Temperature Range	-55 to 150	$^\circ\text{C}$	
R_{thJC} Max. Thermal Resistance Junction to Case	1.50	$^\circ\text{C}/\text{W}$	DC operation * See Fig. 4
R_{thCS} Typical Thermal Resistance, Case to Heatsink	0.50	$^\circ\text{C}/\text{W}$	Mounting surface, smooth and greased
wt Approximate Weight	2 (0.07)		g (oz.)
T Mounting Torque	Min. 6 (5)	Kg-cm (lbf-in)	
	Max. 12 (10)		
Marking Device	20TQ045	Case Style TO-220	
	20TQ045S	Case Style D ² Pak	

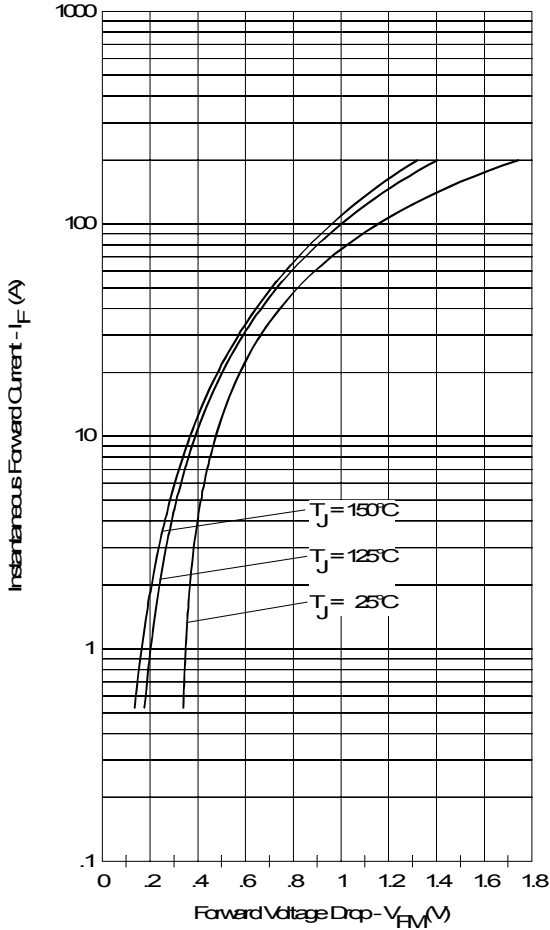

Fig. 1 - Maximum Forward Voltage Drop Characteristics

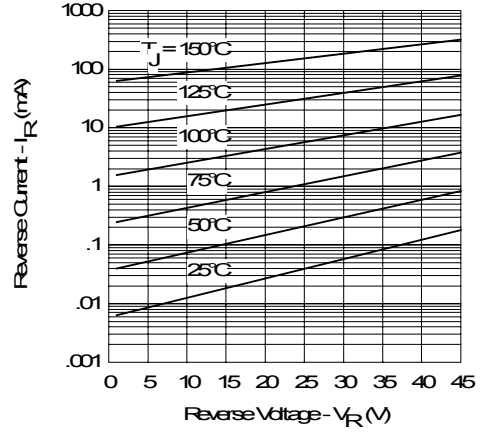

Fig. 2 - Typical Values of Reverse Current Vs. Reverse Voltage

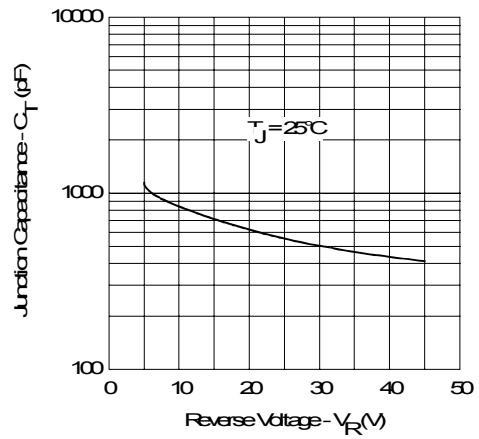

Fig. 3 - Typical Junction Capacitance Vs. Reverse Voltage

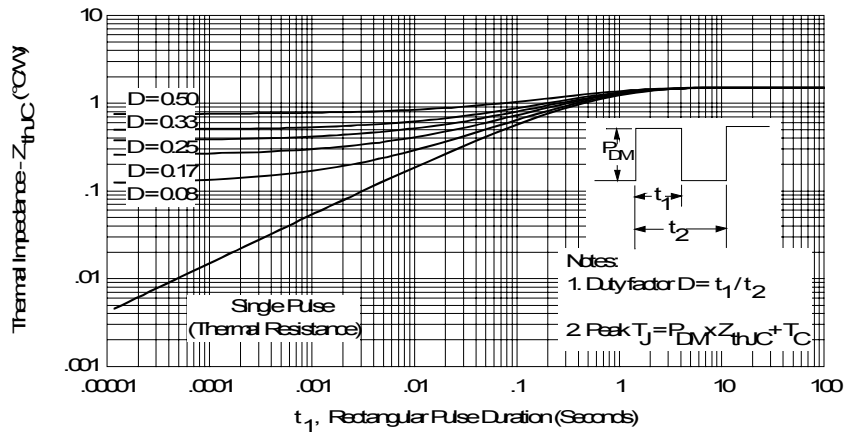

Fig. 4 - Maximum Thermal Impedance Z_{thJC} Characteristics

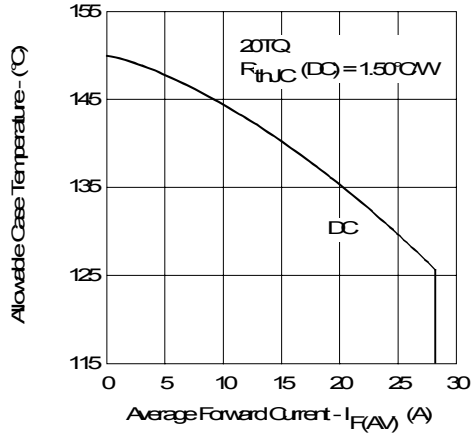

Fig. 5 - Maximum Allowable Case Temperature Vs. Average Forward Current

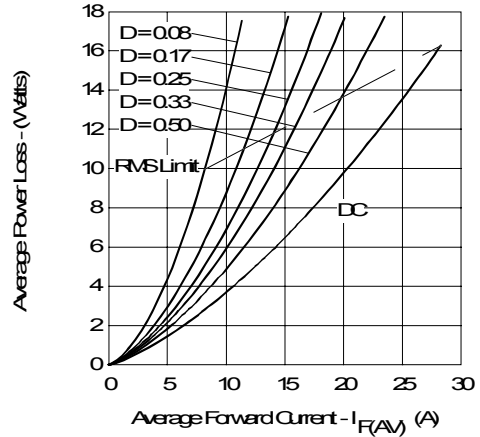

Fig. 6 - Forward Power Loss Characteristics

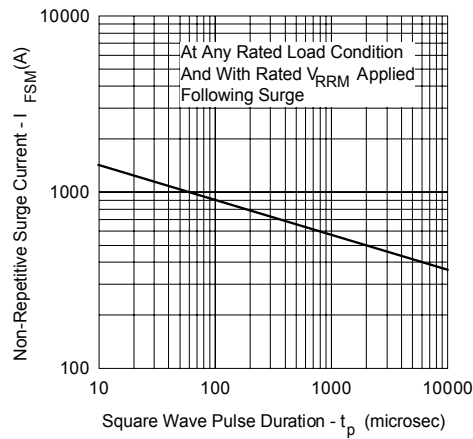

Fig. 7 - Maximum Non-Repetitive Surge Current

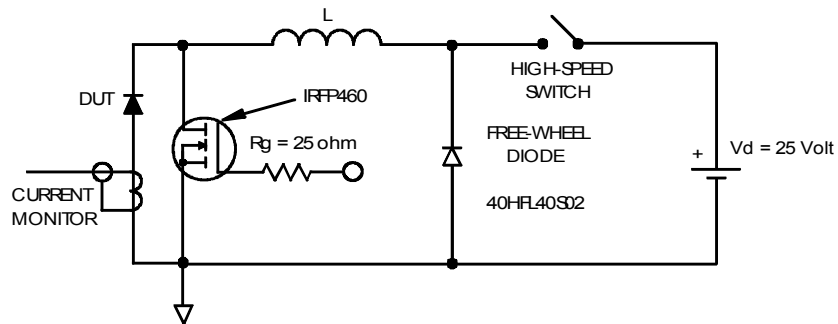
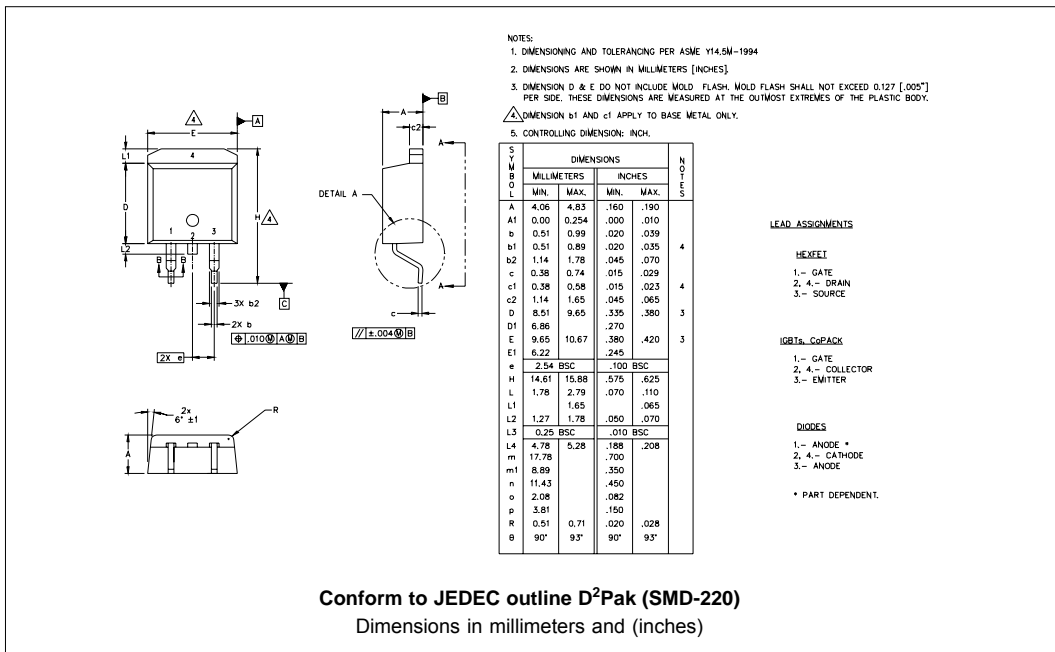
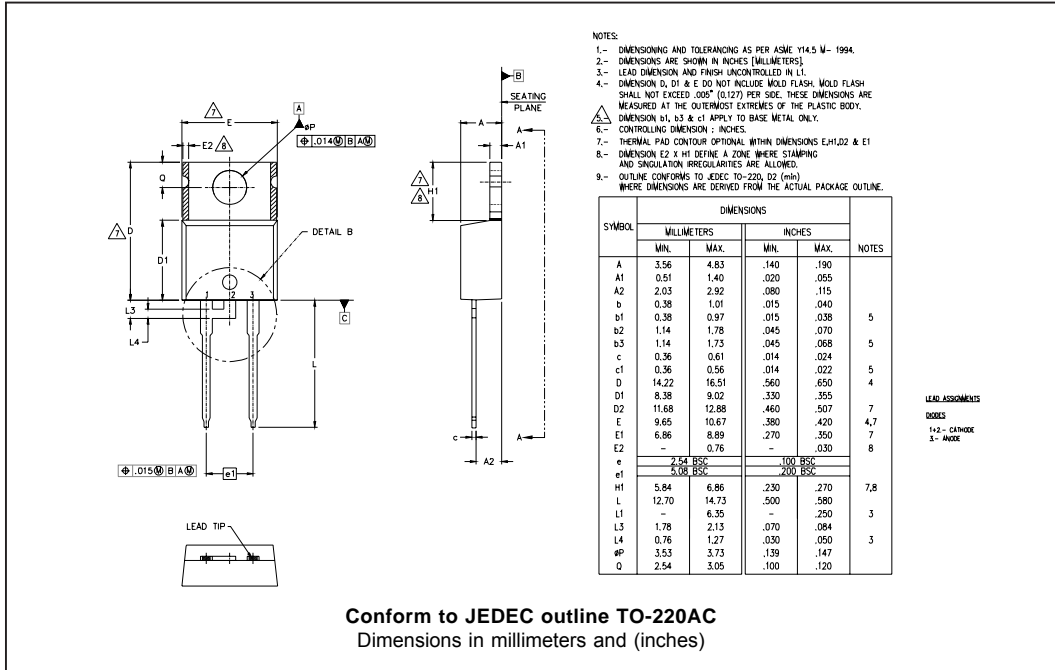

Fig. 8 - Unclamped Inductive Test Circuit

Outline Table



Part Marking Information

TO-220AC

EXAMPLE: THIS IS A 20TQ045
LOT CODE 1789
ASSEMBLED ON WW 19, 2001
IN THE ASSEMBLY LINE "C"

INTERNATIONAL RECTIFIER LOGO
ASSEMBLY LOT CODE
PART NUMBER
DATE CODE
YEAR 1 = 2001
WEEK 19
LINE C

D²Pak

EXAMPLE: THIS IS A 20TQ045S
LOT CODE 8024
ASSEMBLED ON WW 02, 2000

INTERNATIONAL RECTIFIER LOGO
ASSEMBLY LOT CODE
PART NUMBER
DATE CODE
YEAR 0 = 2000
WEEK 02
LINE C

Tape & Reel Information

SECTION Y-Y

NOTES:

- 1.0 10 SPROCKET HOLE PITH CUMULATIVE TOLERANCE ±.02
- 2.0 CAMBER NOT TO EXCEED 1mm in 100mm
- 3.0 MATERIAL: CONDUCTIVE BLACK STYRENIC ALLOY
- 4.0 Ko MEASURED FROM A PLANE ON THE INSIDE BOTTOM OF THE POCKET TO THE TOP SURFACE OF THE CARRIER
- 5.0 MEASURED FROM CENTRELINE OF SPROCKET HOLE TO CENTRELINE OF POCKET
- 6.0 VENDOR: (OPTIONAL)
- 7.0 MUST ALSO MEET REQUIREMENTS OF EIA STANDAR #EIA-481A TAPING OF SURFACE MOUNT COMPONENTS FOR AUTOMATIC PLACEMENT
- 8.0 SURFACE RESISTIVITY OF MOLDED MATL. MUST MEASURE LESS OR EQUAL TO 10⁶ OHMS PER SQUARE. MEASURED IN ACCORDANCE TO PROCEDURE GIVEN IN ASTM D-257 & ASTM D-991
- 9.0 TOTAL LENGTH PER REEL MUST BE 45 METERS
- 10.0 © CRITICAL

Ao	10.50	+/- 0.1
Bo	15.80	+/- 0.1
B2	10.25	+/- 0.1
Ko	4.90	+/- 0.1
F	11.50	+/- 0.1
P1	16.00	+/- 0.1
W	24.00	+/- 0.3

Dimensions in millimeters and (inches)

Ordering Information Table

Device Code					
20	T	Q	045	S	-
(1)	(2)	(3)	(4)	(5)	(6)

<p>1 - Current Rating (20 = 20A)</p> <p>2 - Package T = TO-220</p> <p>3 - Schottky "Q" Series</p> <p>4 - Voltage Ratings</p> <p>5 - • none = TO-220 • S = D²Pak</p> <p>6 - • none = Standard Production • PbF = Lead-Free</p>	<table border="1"> <tr> <td>035 = 35V</td> </tr> <tr> <td>040 = 40V</td> </tr> <tr> <td>045 = 45V</td> </tr> </table>	035 = 35V	040 = 40V	045 = 45V
035 = 35V				
040 = 40V				
045 = 45V				

Tube Standard Pack Quantity : 50 pieces

Data and specifications subject to change without notice.
 This product has been designed and qualified for Industrial Level.
 Qualification Standards can be found on IR's Web site.