

# MMBT2222LT1, MMBT2222ALT1

MMBT2222ALT1 is a Preferred Device

## General Purpose Transistors

NPN Silicon



ON Semiconductor™

<http://onsemi.com>

### MAXIMUM RATINGS

Rating	Symbol	Value	Unit
Collector–Emitter Voltage MMBT2222LT1 MMBT2222ALT1	$V_{CEO}$	30 40	Vdc
Collector–Base Voltage MMBT2222LT1 MMBT2222ALT1	$V_{CBO}$	60 75	Vdc
Emitter–Base Voltage MMBT2222LT1 MMBT2222ALT1	$V_{EBO}$	5.0 6.0	Vdc
Collector Current – Continuous	$I_C$	600	mAdc

### THERMAL CHARACTERISTICS

Characteristic	Symbol	Max	Unit
Total Device Dissipation FR–5 Board (Note 1) $T_A = 25^\circ\text{C}$ Derate above $25^\circ\text{C}$	$P_D$	225	mW
Thermal Resistance Junction to Ambient	$R_{\theta JA}$	556	$^\circ\text{C}/\text{W}$
Total Device Dissipation Alumina Substrate (Note 2) $T_A = 25^\circ\text{C}$ Derate above $25^\circ\text{C}$	$P_D$	300	mW
Thermal Resistance Junction to Ambient	$R_{\theta JA}$	417	$^\circ\text{C}/\text{W}$
Junction and Storage Temperature Range	$T_J, T_{stg}$	–55 to +150	$^\circ\text{C}$

- FR–5 =  $1.0 \times 0.75 \times 0.062$  in.
- Alumina =  $0.4 \times 0.3 \times 0.024$  in. 99.5% alumina.

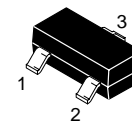
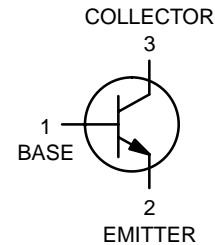

SOT–23  
CASE 318  
STYLE 6

### MARKING DIAGRAM

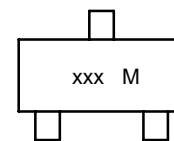

xxx = Specific Device Code  
(M1B = MMBT2222LT1,  
1P = MMBT2222ALT1)  
M = Date Code

### ORDERING INFORMATION

Device	Package	Shipping
MMBT2222LT1	SOT–23	3000/Tape & Reel
MMBT2222ALT1	SOT–23	3000/Tape & Reel
MMBT2222LT3	SOT–23	10,000/Tape & Reel
MMBT2222ALT3	SOT–23	10,000/Tape & Reel

Preferred devices are recommended choices for future use and best overall value.

# MMBT2222LT1, MMBT2222ALT1

## ELECTRICAL CHARACTERISTICS ( $T_A = 25^\circ\text{C}$ unless otherwise noted)

Characteristic		Symbol	Min	Max	Unit
<b>OFF CHARACTERISTICS</b>					
Collector–Emitter Breakdown Voltage ( $I_C = 10\text{ mAdc}$ , $I_B = 0$ )	MMBT2222 MMBT2222A	$V_{(BR)CEO}$	30 40	– –	Vdc
Collector–Base Breakdown Voltage ( $I_C = 10\text{ }\mu\text{Adc}$ , $I_E = 0$ )	MMBT2222 MMBT2222A	$V_{(BR)CBO}$	60 75	– –	Vdc
Emitter–Base Breakdown Voltage ( $I_E = 10\text{ }\mu\text{Adc}$ , $I_C = 0$ )	MMBT2222 MMBT2222A	$V_{(BR)EBO}$	5.0 6.0	– –	Vdc
Collector Cutoff Current ( $V_{CE} = 60\text{ Vdc}$ , $V_{EB(off)} = 3.0\text{ Vdc}$ )	MMBT2222A	$I_{CEX}$	–	10	nAdc
Collector Cutoff Current ( $V_{CB} = 50\text{ Vdc}$ , $I_E = 0$ )	MMBT2222	$I_{CBO}$	–	0.01	$\mu\text{Adc}$
( $V_{CB} = 60\text{ Vdc}$ , $I_E = 0$ )	MMBT2222A		–	0.01	
( $V_{CB} = 50\text{ Vdc}$ , $I_E = 0$ , $T_A = 125^\circ\text{C}$ )	MMBT2222		–	10	
( $V_{CB} = 60\text{ Vdc}$ , $I_E = 0$ , $T_A = 125^\circ\text{C}$ )	MMBT2222A		–	10	
Emitter Cutoff Current ( $V_{EB} = 3.0\text{ Vdc}$ , $I_C = 0$ )	MMBT2222A	$I_{EBO}$	–	100	nAdc
Base Cutoff Current ( $V_{CE} = 60\text{ Vdc}$ , $V_{EB(off)} = 3.0\text{ Vdc}$ )	MMBT2222A	$I_{BL}$	–	20	nAdc

## ON CHARACTERISTICS

DC Current Gain ( $I_C = 0.1\text{ mAdc}$ , $V_{CE} = 10\text{ Vdc}$ ) ( $I_C = 1.0\text{ mAdc}$ , $V_{CE} = 10\text{ Vdc}$ ) ( $I_C = 10\text{ mAdc}$ , $V_{CE} = 10\text{ Vdc}$ ) ( $I_C = 10\text{ mAdc}$ , $V_{CE} = 10\text{ Vdc}$ , $T_A = -55^\circ\text{C}$ ) ( $I_C = 150\text{ mAdc}$ , $V_{CE} = 10\text{ Vdc}$ ) (Note 1.) ( $I_C = 150\text{ mAdc}$ , $V_{CE} = 1.0\text{ Vdc}$ ) (Note 1.) ( $I_C = 500\text{ mAdc}$ , $V_{CE} = 10\text{ Vdc}$ ) (Note 1.)	MMBT2222A only      MMBT2222 MMBT2222A	$h_{FE}$	35 50 75 35 100 50 30 40	– – – – 300 – – –	–
Collector–Emitter Saturation Voltage (Note 1.) ( $I_C = 150\text{ mAdc}$ , $I_B = 15\text{ mAdc}$ )  ( $I_C = 500\text{ mAdc}$ , $I_B = 50\text{ mAdc}$ )	MMBT2222 MMBT2222A  MMBT2222 MMBT2222A	$V_{CE(sat)}$	– – – –	0.4 0.3 1.6 1.0	Vdc
Base–Emitter Saturation Voltage (Note 1.) ( $I_C = 150\text{ mAdc}$ , $I_B = 15\text{ mAdc}$ )  ( $I_C = 500\text{ mAdc}$ , $I_B = 50\text{ mAdc}$ )	MMBT2222 MMBT2222A  MMBT2222 MMBT2222A	$V_{BE(sat)}$	– 0.6 – –	1.3 1.2 2.6 2.0	Vdc

1. Pulse Test: Pulse Width  $\leq 300\text{ }\mu\text{s}$ , Duty Cycle  $\leq 2.0\%$ .

# MMBT2222LT1, MMBT2222ALT1

## SMALL-SIGNAL CHARACTERISTICS

Current-Gain – Bandwidth Product (Note 2.) ( $I_C = 20 \text{ mA}$ , $V_{CE} = 20 \text{ Vdc}$ , $f = 100 \text{ MHz}$ )	MMBT2222 MMBT2222A	$f_T$	250 300	– –	MHz
Output Capacitance ( $V_{CB} = 10 \text{ Vdc}$ , $I_E = 0$ , $f = 1.0 \text{ MHz}$ )		$C_{obo}$	–	8.0	pF
Input Capacitance ( $V_{EB} = 0.5 \text{ Vdc}$ , $I_C = 0$ , $f = 1.0 \text{ MHz}$ )	MMBT2222 MMBT2222A	$C_{ibo}$	– –	30 25	pF
Input Impedance ( $I_C = 1.0 \text{ mA}$ , $V_{CE} = 10 \text{ Vdc}$ , $f = 1.0 \text{ kHz}$ ) ( $I_C = 10 \text{ mA}$ , $V_{CE} = 10 \text{ Vdc}$ , $f = 1.0 \text{ kHz}$ )	MMBT2222A MMBT2222A	$h_{ie}$	2.0 0.25	8.0 1.25	$k\Omega$
Voltage Feedback Ratio ( $I_C = 1.0 \text{ mA}$ , $V_{CE} = 10 \text{ Vdc}$ , $f = 1.0 \text{ kHz}$ ) ( $I_C = 10 \text{ mA}$ , $V_{CE} = 10 \text{ Vdc}$ , $f = 1.0 \text{ kHz}$ )	MMBT2222A MMBT2222A	$h_{re}$	– –	8.0 4.0	$\times 10^{-4}$
Small-Signal Current Gain ( $I_C = 1.0 \text{ mA}$ , $V_{CE} = 10 \text{ Vdc}$ , $f = 1.0 \text{ kHz}$ ) ( $I_C = 10 \text{ mA}$ , $V_{CE} = 10 \text{ Vdc}$ , $f = 1.0 \text{ kHz}$ )	MMBT2222A MMBT2222A	$h_{fe}$	50 75	300 375	–
Output Admittance ( $I_C = 1.0 \text{ mA}$ , $V_{CE} = 10 \text{ Vdc}$ , $f = 1.0 \text{ kHz}$ ) ( $I_C = 10 \text{ mA}$ , $V_{CE} = 10 \text{ Vdc}$ , $f = 1.0 \text{ kHz}$ )	MMBT2222A MMBT2222A	$h_{oe}$	5.0 25	35 200	$\mu\text{mhos}$
Collector Base Time Constant ( $I_E = 20 \text{ mA}$ , $V_{CB} = 20 \text{ Vdc}$ , $f = 31.8 \text{ MHz}$ )	MMBT2222A	$r_b, C_c$	–	150	ps
Noise Figure ( $I_C = 100 \mu\text{A}$ , $V_{CE} = 10 \text{ Vdc}$ , $R_S = 1.0 \text{ k}\Omega$ , $f = 1.0 \text{ kHz}$ )	MMBT2222A	NF	–	4.0	dB

## SWITCHING CHARACTERISTICS (MMBT2222A only)

Delay Time	$(V_{CC} = 30 \text{ Vdc}$ , $V_{BE(\text{off})} = -0.5 \text{ Vdc}$ , $I_C = 150 \text{ mA}$ , $I_{B1} = 15 \text{ mA}$ )	$t_d$	–	10	ns
Rise Time		$t_r$	–	25	
Storage Time	$(V_{CC} = 30 \text{ Vdc}$ , $I_C = 150 \text{ mA}$ , $I_{B1} = I_{B2} = 15 \text{ mA}$ )	$t_s$	–	225	ns
Fall Time		$t_f$	–	60	

2.  $f_T$  is defined as the frequency at which  $|h_{fe}|$  extrapolates to unity.

## SWITCHING TIME EQUIVALENT TEST CIRCUITS

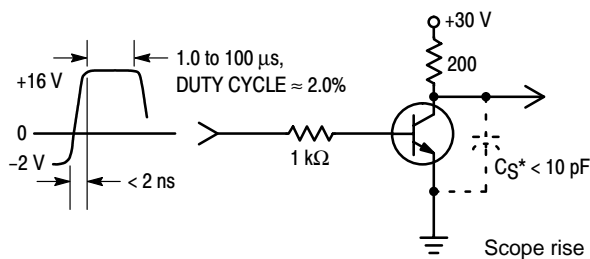

Figure 1. Turn-On Time

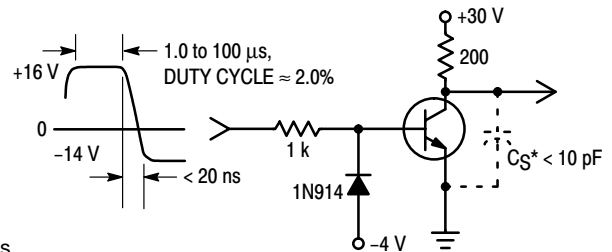

Figure 2. Turn-Off Time

# MMBT2222LT1, MMBT2222ALT1

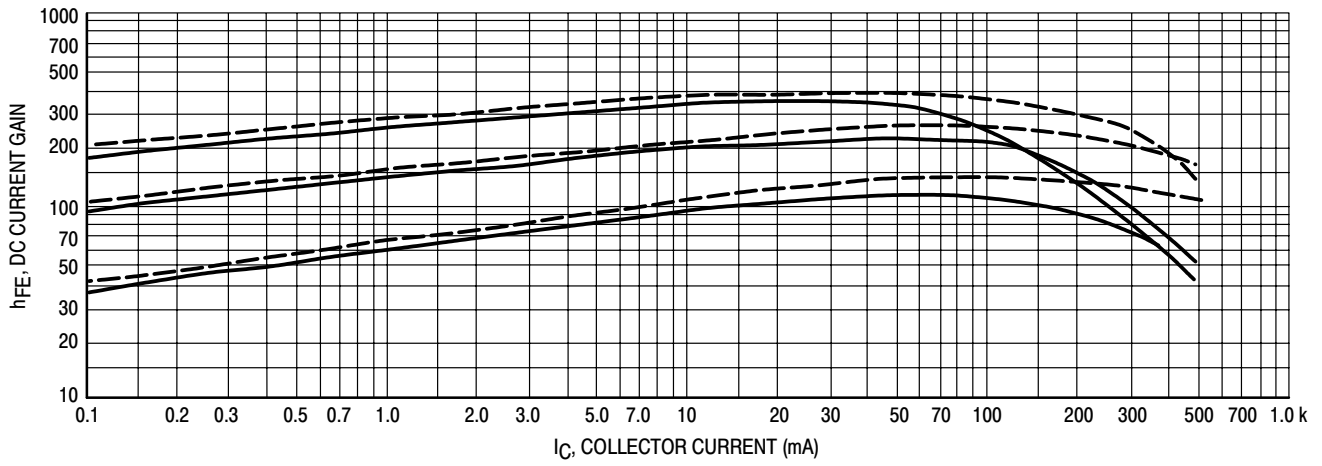

Figure 3. DC Current Gain

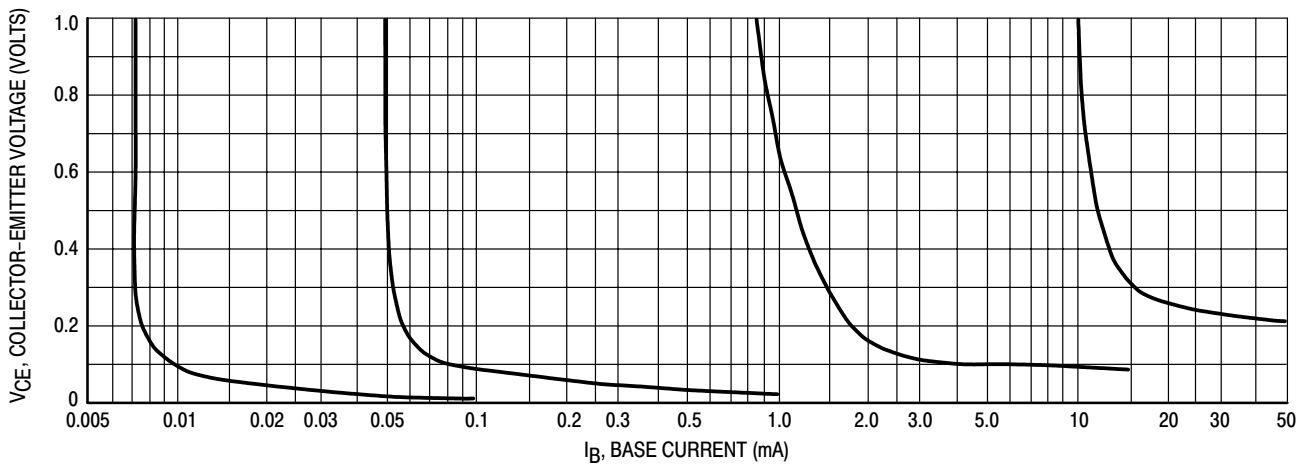

Figure 4. Collector Saturation Region

# MMBT2222LT1, MMBT2222ALT1

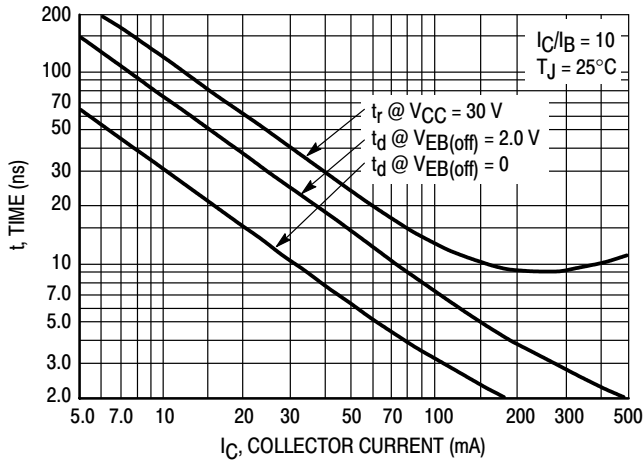

Figure 5. Turn-On Time

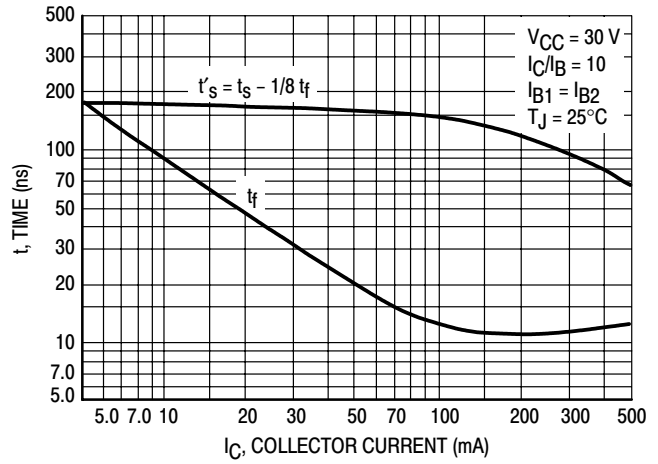

Figure 6. Turn-Off Time

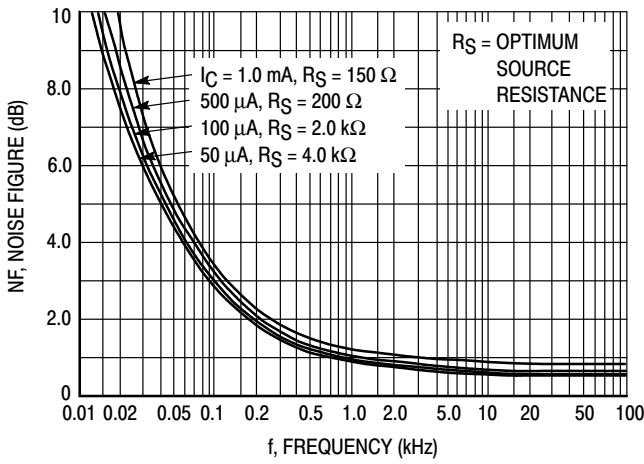

Figure 7. Frequency Effects

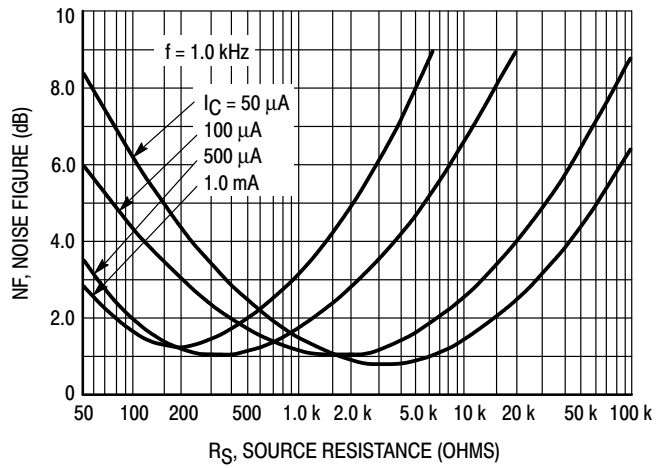

Figure 8. Source Resistance Effects

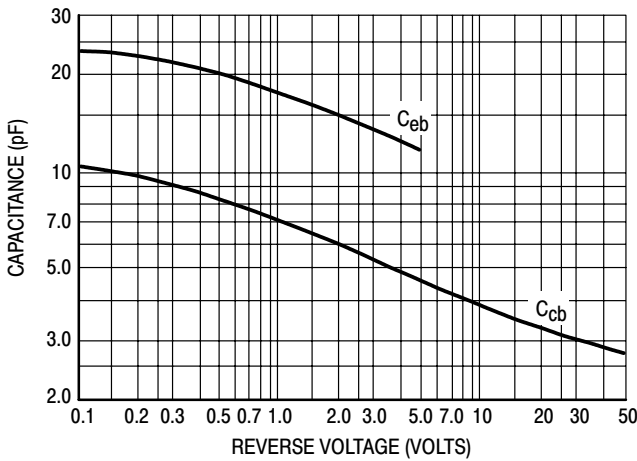

Figure 9. Capacitances

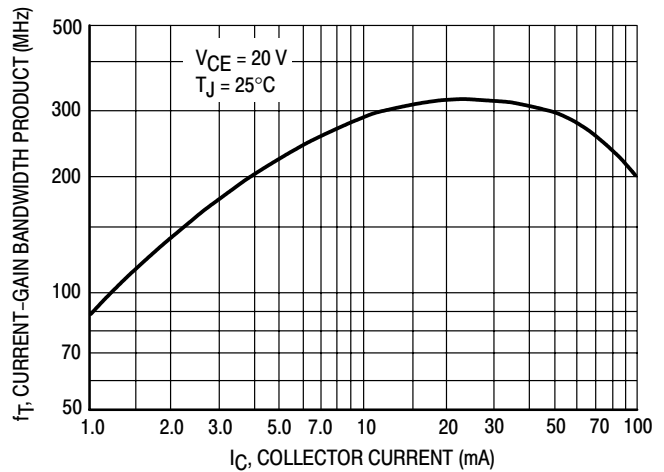

Figure 10. Current-Gain Bandwidth Product

# MMBT2222LT1, MMBT2222ALT1

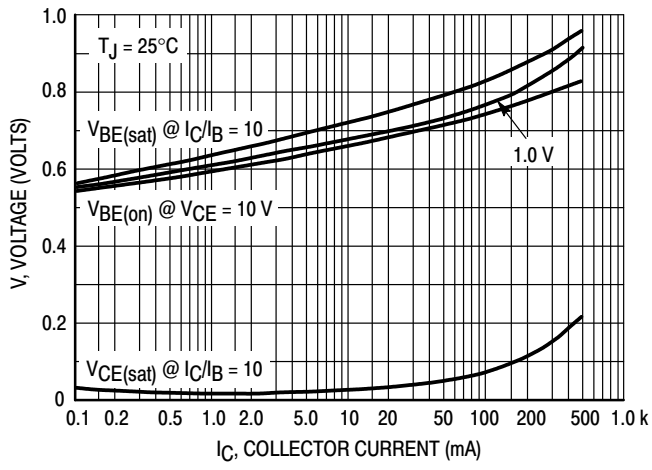

Figure 11. "On" Voltages

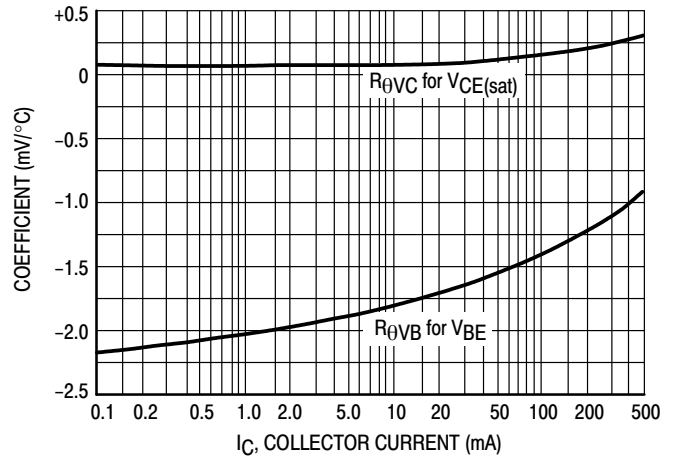

Figure 12. Temperature Coefficients

**INFORMATION FOR USING THE SOT-23 SURFACE MOUNT PACKAGE**

**MINIMUM RECOMMENDED FOOTPRINT FOR SURFACE MOUNTED APPLICATIONS**

Surface mount board layout is a critical portion of the total design. The footprint for the semiconductor packages must be the correct size to insure proper solder connection

interface between the board and the package. With the correct pad geometry, the packages will self align when subjected to a solder reflow process.

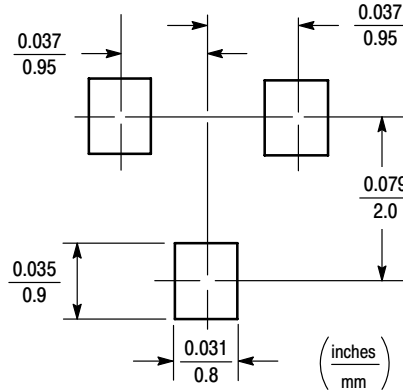

**SOT-23**

**SOT-23 POWER DISSIPATION**

The power dissipation of the SOT-23 is a function of the pad size. This can vary from the minimum pad size for soldering to a pad size given for maximum power dissipation. Power dissipation for a surface mount device is determined by  $T_{J(max)}$ , the maximum rated junction temperature of the die,  $R_{\theta JA}$ , the thermal resistance from the device junction to ambient, and the operating temperature,  $T_A$ . Using the values provided on the data sheet for the SOT-23 package,  $P_D$  can be calculated as follows:

$$P_D = \frac{T_{J(max)} - T_A}{R_{\theta JA}}$$

The values for the equation are found in the maximum ratings table on the data sheet. Substituting these values into the equation for an ambient temperature  $T_A$  of 25°C, one can calculate the power dissipation of the device which in this case is 225 milliwatts.

$$P_D = \frac{150^\circ\text{C} - 25^\circ\text{C}}{556^\circ\text{C/W}} = 225 \text{ milliwatts}$$

The 556°C/W for the SOT-23 package assumes the use of the recommended footprint on a glass epoxy printed circuit board to achieve a power dissipation of 225 milliwatts. There are other alternatives to achieving higher power dissipation from the SOT-23 package. Another alternative would be to use a ceramic substrate or an aluminum core board such as Thermal Clad™. Using a board material such as Thermal Clad, an aluminum core board, the power dissipation can be doubled using the same footprint.

**SOLDERING PRECAUTIONS**

The melting temperature of solder is higher than the rated temperature of the device. When the entire device is heated to a high temperature, failure to complete soldering within a short time could result in device failure. Therefore, the following items should always be observed in order to minimize the thermal stress to which the devices are subjected.

- Always preheat the device.
- The delta temperature between the preheat and soldering should be 100°C or less.\*
- When preheating and soldering, the temperature of the leads and the case must not exceed the maximum temperature ratings as shown on the data sheet. When using infrared heating with the reflow soldering method, the difference shall be a maximum of 10°C.
- The soldering temperature and time shall not exceed 260°C for more than 10 seconds.
- When shifting from preheating to soldering, the maximum temperature gradient shall be 5°C or less.
- After soldering has been completed, the device should be allowed to cool naturally for at least three minutes. Gradual cooling should be used as the use of forced cooling will increase the temperature gradient and result in latent failure due to mechanical stress.
- Mechanical stress or shock should not be applied during cooling.

\* Soldering a device without preheating can cause excessive thermal shock and stress which can result in damage to the device.

# MMBT2222LT1, MMBT2222ALT1

## PACKAGE DIMENSIONS

### SOT-23 (TO-236) CASE 318-08 ISSUE AF

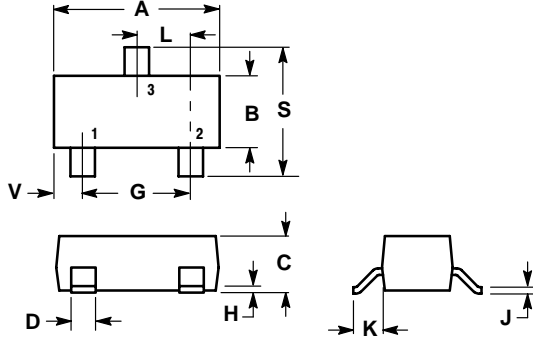

#### NOTES:

1. DIMENSIONING AND TOLERANCING PER ANSI Y14.5M, 1982.
2. CONTROLLING DIMENSION: INCH.
3. MAXIMUM LEAD THICKNESS INCLUDES LEAD FINISH THICKNESS. MINIMUM LEAD THICKNESS IS THE MINIMUM THICKNESS OF BASE MATERIAL.

DIM	INCHES		MILLIMETERS	
	MIN	MAX	MIN	MAX
A	0.1102	0.1197	2.80	3.04
B	0.0472	0.0551	1.20	1.40
C	0.0350	0.0440	0.89	1.11
D	0.0150	0.0200	0.37	0.50
G	0.0701	0.0807	1.78	2.04
H	0.0005	0.0040	0.013	0.100
J	0.0034	0.0070	0.085	0.177
K	0.0140	0.0285	0.35	0.69
L	0.0350	0.0401	0.89	1.02
S	0.0830	0.1039	2.10	2.64
V	0.0177	0.0236	0.45	0.60

#### STYLE 6:

1. BASE
2. EMITTER
3. COLLECTOR

Thermal Clad is a registered trademark of the Bergquist Company

**ON Semiconductor** and  are trademarks of Semiconductor Components Industries, LLC (SCILLC). SCILLC reserves the right to make changes without further notice to any products herein. SCILLC makes no warranty, representation or guarantee regarding the suitability of its products for any particular purpose, nor does SCILLC assume any liability arising out of the application or use of any product or circuit, and specifically disclaims any and all liability, including without limitation special, consequential or incidental damages. "Typical" parameters which may be provided in SCILLC data sheets and/or specifications can and do vary in different applications and actual performance may vary over time. All operating parameters, including "Typicals" must be validated for each customer application by customer's technical experts. SCILLC does not convey any license under its patent rights nor the rights of others. SCILLC products are not designed, intended, or authorized for use as components in systems intended for surgical implant into the body, or other applications intended to support or sustain life, or for any other application in which the failure of the SCILLC product could create a situation where personal injury or death may occur. Should Buyer purchase or use SCILLC products for any such unintended or unauthorized application, Buyer shall indemnify and hold SCILLC and its officers, employees, subsidiaries, affiliates, and distributors harmless against all claims, costs, damages, and expenses, and reasonable attorney fees arising out of, directly or indirectly, any claim of personal injury or death associated with such unintended or unauthorized use, even if such claim alleges that SCILLC was negligent regarding the design or manufacture of the part. SCILLC is an Equal Opportunity/Affirmative Action Employer.

## PUBLICATION ORDERING INFORMATION

#### Literature Fulfillment:

Literature Distribution Center for ON Semiconductor  
P.O. Box 5163, Denver, Colorado 80217 USA  
Phone: 303-675-2175 or 800-344-3860 Toll Free USA/Canada  
Fax: 303-675-2176 or 800-344-3867 Toll Free USA/Canada  
Email: ONlit@hibbertco.com

**N. American Technical Support:** 800-282-9855 Toll Free USA/Canada

**JAPAN:** ON Semiconductor, Japan Customer Focus Center  
4-32-1 Nishi-Gotanda, Shinagawa-ku, Tokyo, Japan 141-0031  
Phone: 81-3-5740-2700  
Email: r14525@onsemi.com

**ON Semiconductor Website:** <http://onsemi.com>

For additional information, please contact your local Sales Representative.