

LA4663

Two-Channel 16-W BTL General-Purpose Audio Power Amplifier

Overview

The LA4663 is a BTL 2-channel power amplifier IC that was developed for ease of use in general audio applications. In addition to providing improvements in a wide range of electrical characteristics, the LA4663 aims for improved listenability and an excellent cost-performance ratio.

Applications

Radio/cassette players with built-in CD/MD players, microcomponent stereo systems, active speakers, electronic musical instruments, and other audio devices.

Features

- Wide operating supply voltage range (V_{CCop}): 5.5 to 22 V (Certain conditions may apply.)
- High ripple rejection ratio: 60 dB (typical)
- Power: 16 W \times 2 ($V_{CC} = 15$ V/6 Ω), 13 W \times 2 ($V_{CC} = 12$ V/4 Ω), 6.5 W \times 2 ($V_{CC} = 9$ V/4 Ω)
- Built-in signal muting circuit (AC muting) reduces the number of external components and provides muting with minimal switching noise.
- Startup circuit with a start time of 0.6 to 0.7 seconds. The LA4663 provides distortion-free startup, since output is only generated after the supply voltage reaches the midpoint at power on.

(The startup time can be modified in end products by using this circuit in conjunction with the muting circuit described above.)

- Full complement of built-in protection circuits (protection from shorting to ground, shorting to V_{CC} , load shorting, and overheating)
- High audio quality, minimal impulse noise

Package Dimensions

unit: mm

3113A-SIP14HZ

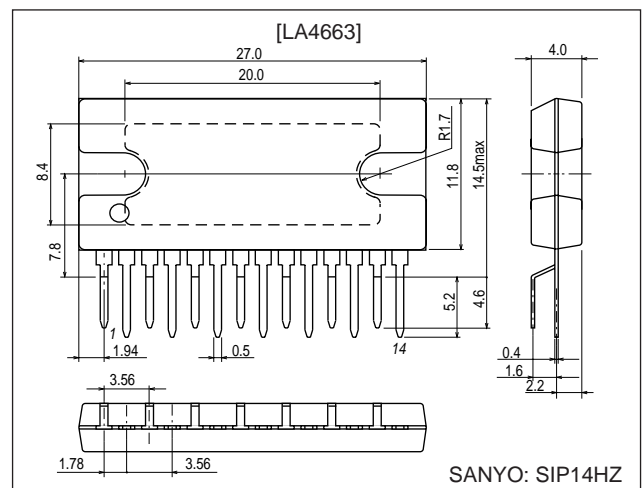

Specifications

Maximum Ratings at $T_a = 25^\circ\text{C}$

Parameter	Symbol	Conditions	Ratings	Unit
Maximum supply voltage	V_{CC} max	No signal	24	V
Maximum output current	I_O peak	Per channel	3.5	A
Allowable power dissipation	P_d max	With an arbitrarily large heat sink	37.5	W
Operating temperature	T_{opr}		-20 to +75	$^\circ\text{C}$
Storage temperature	T_{stg}		-40 to +150	$^\circ\text{C}$

■ Any and all SANYO products described or contained herein do not have specifications that can handle applications that require extremely high levels of reliability, such as life-support systems, aircraft's control systems, or other applications whose failure can be reasonably expected to result in serious physical and/or material damage. Consult with your SANYO representative nearest you before using any SANYO products described or contained herein in such applications.

■ SANYO assumes no responsibility for equipment failures that result from using products at values that exceed, even momentarily, rated values (such as maximum ratings, operating condition ranges, or other parameters) listed in products specifications of any and all SANYO products described or contained herein.

SANYO Electric Co., Ltd. Semiconductor Company

TOKYO OFFICE Tokyo Bldg., 1-10, 1 Chome, Ueno, Taito-ku, TOKYO, 110-8534 JAPAN

Operating Conditions *1 at Ta = 25°C

Parameter	Symbol	Conditions	Ratings	Unit
Recommended supply voltage	V _{CC}		12, 15	V
Recommended load resistance range	R _L op		4 to 8	Ω
Allowable operating supply voltage range *2	V _{CC} op	When R _L = 8 Ω	5.5 to 21	V
		When R _L = 6 Ω	5.5 to 20	V
		When R _L = 5 Ω	5.5 to 17	V
		When R _L = 4 Ω	5.5 to 15	V

Note *:1. When used with V_{CC}, R_L, and output level ranges such that Pd max for the heat sink actually used is not exceeded.

2. When both channels are operating with I_O peak values that exceed 2 A per channel.

If the I_O peak value does not exceed 2 A per channel, a range of 5.5 to 22 V is allowed for any allowable R_L (for ranges where Pd max is not exceeded).

Operating Characteristics at Ta = 25°C, V_{CC} = 15 V, R_L = 4 Ω, f = 1 kHz, Rg = 600 Ω

Parameter	Symbol	Conditions	Ratings			Unit
			min	typ	max	
Quiescent current	I _{CCO}	Rg = 0, R _L = open	60	100	180	mA
Standby current	I _{st}	When standby is off and with no power supply capacitor		1	10	μA
Voltage gain	V _G	V _O = 0 dBm	38	40	42	dB
Total harmonic distortion	THD	P _O = 1 W, Filter = FLAT		0.07	0.4	%
Output power	P _{O1}	V _{CC} = 15 V, THD = 10%, R _L = 4 Ω	16	20		W
	P _{O2}	V _{CC} = 12 V, THD = 10%, R _L = 4 Ω		13		W
	P _{O3}	V _{CC} = 12 V, THD = 10%, R _L = 6 Ω		10		W
Output offset voltage	V _N offset	Rg = 0	-300		+300	mV
Output noise voltage	V _{NO}	Rg = 0, BPF = 20 Hz to 20 kHz		0.2	0.5	mV
Ripple rejection ratio	SVRR	Rg = 0, V _R = 0 dBm, f _R = 100 Hz	50	60		dB
Channel separation	CH sep	Rg = 10 kΩ, V _O = 0 dBm	50	60		dB
Input resistance	R _i		14	20	26	kΩ
Standby pin applied voltage	V _{ST}	Amplifier on (the pin 5 voltage)	2.5		10	V
Muting pin applied voltage	V _M	Muting on (the pin 6 voltage)	1.5		3	V
Muting attenuation	ATT _M	Muting on (V _O = 1 V rms), BPF = 20 Hz to 20 kHz	70	80		dB

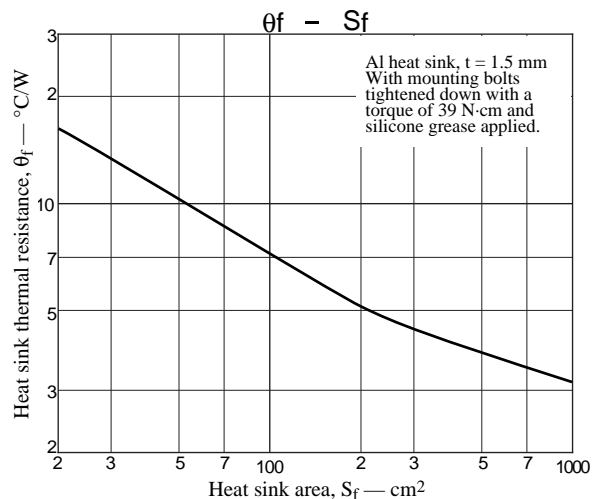
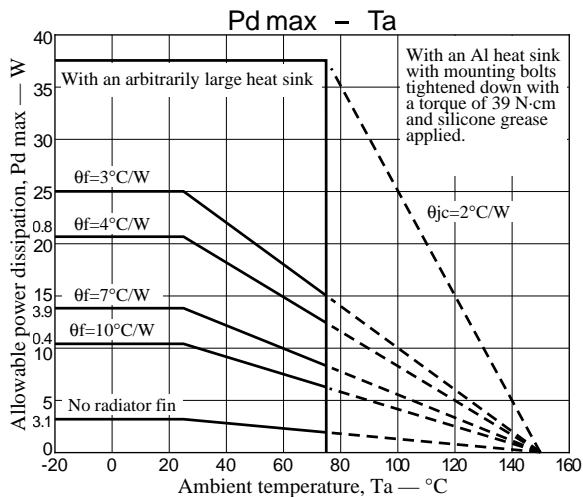

Usage Notes

1. Maximum ratings

If the device is operated in the vicinity of the maximum ratings, it is possible for small changes in the operating conditions to result in the maximum ratings being exceeded. Since this can result in destruction of the device, applications should be designed with adequate margins in the supply voltage and other parameters so that the maximum ratings are never exceeded during device operation.

2. Protection circuits

While the LA4663 includes a full complement of built-in protection circuits, care is required in the usage. In particular, be careful not to short any pairs of device pins together.

[Notes on the shorting (power, ground, and load shorting) protection circuit]

- This protection circuit operates whenever a power short (a short between the output and V_{CC}), a ground short (a short between the output and ground), or a load short (shorting between the + and – outputs) is detected. Although there are cases where the protection circuit may not operate if the supply voltage is under 9 V, the thermal protection circuit will protect the device in this range.
- The protection circuit continues to operate during the interval that the abnormal short continues, and automatically recovers when the error state is resolved. However, under certain usage conditions, there are situations where the protection circuit may lock and remain locked even after the problem has been resolved. In these cases, the circuit can be reset by switching to standby mode or turning off the power temporarily.
- If the output is shorted to V_{CC} with the IC in the standby state and furthermore, a V_{CC} of 20 V or higher applied, an offset will be created between the + and – outputs. If a load is connected in this state, a current will flow in that load, and the IC may be destroyed. Applications should assure that this does not occur.
- In the following situations, the operation of the protection circuit may result in a sound switching phenomenon at high output levels. This may be a problem, depending on the details of the end product circuit itself, and must be verified in an actual system.
- At low load resistances R_L (high loads) and at high V_{CC} voltages, and with both channels operating at I_O peak levels of over 2 A per channel. (This phenomenon is more likely to occur the higher the chip temperature.)

For systems operating under the most sever conditions (high temperatures and high outputs), specific operating conditions such that the above phenomenon does no occur are listed in the “Allowable operating supply voltage range (V_{CC} op)” item in the Operating Conditions section of the specifications. (Refer to the V_{CC} op ranges for different R_L values.)

[Thermal protection circuit]

- A thermal protection circuit is provided to prevent damage to or destruction of the IC itself when the IC generates abnormally high temperatures. This means that gradual attenuation is applied to the output signals by the thermal protection circuit if the IC junction temperature (T_j) rises above about 160°C due to insufficient heat sinking or other problems.

3. Notes on printed circuit boards

- When designing the printed circuit board pattern, keep the input lines separated from both the VCC lines and the output lines. This is to prevent increased distortion and oscillation.
- When high output levels are used, make power-ground lines as wide as possible and as short as possible to prevent the PWR GND pins potential from increasing with respect to pre-ground. (From the standpoint of IC stability, ideally, the ground pin potential should be the lowest potential in the system. This is to prevent trouble caused by several types of induced parasitic devices due to increases in the GND pin potential due to the structure of the IC.)

4. Notes on heat sink mounting

- Use a tightening torque of between 39 and 59 N·cm.
- Make the spacing of the heat sink mounting screw holes the same as the spacing of the IC mounting screw holes. Also, make the mounting screw hole spacing as short as possible within the range that still allows mounting, referring to the external dimensions L and R.

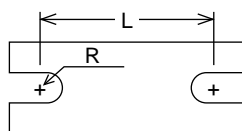

A10629

- For mounting screws, use screws that correspond to either the truss screws or binding screws stipulated by the JIS (Japan Industrial Standards). Use washers to protect the IC case.
- Do not allow any foreign matter, such as machining chips, to get between the IC (package internal) heat sink and the external heat sink. Also, if grease is applied to the junction, apply the grease as evenly as possible.

5. Other notes

- The LA4663 is a BTL power amplifier IC. When connecting this IC to test equipment, do not allow the test equipment grounds for the input and output systems to be shared grounds.

Equivalent Circuit Block Diagram

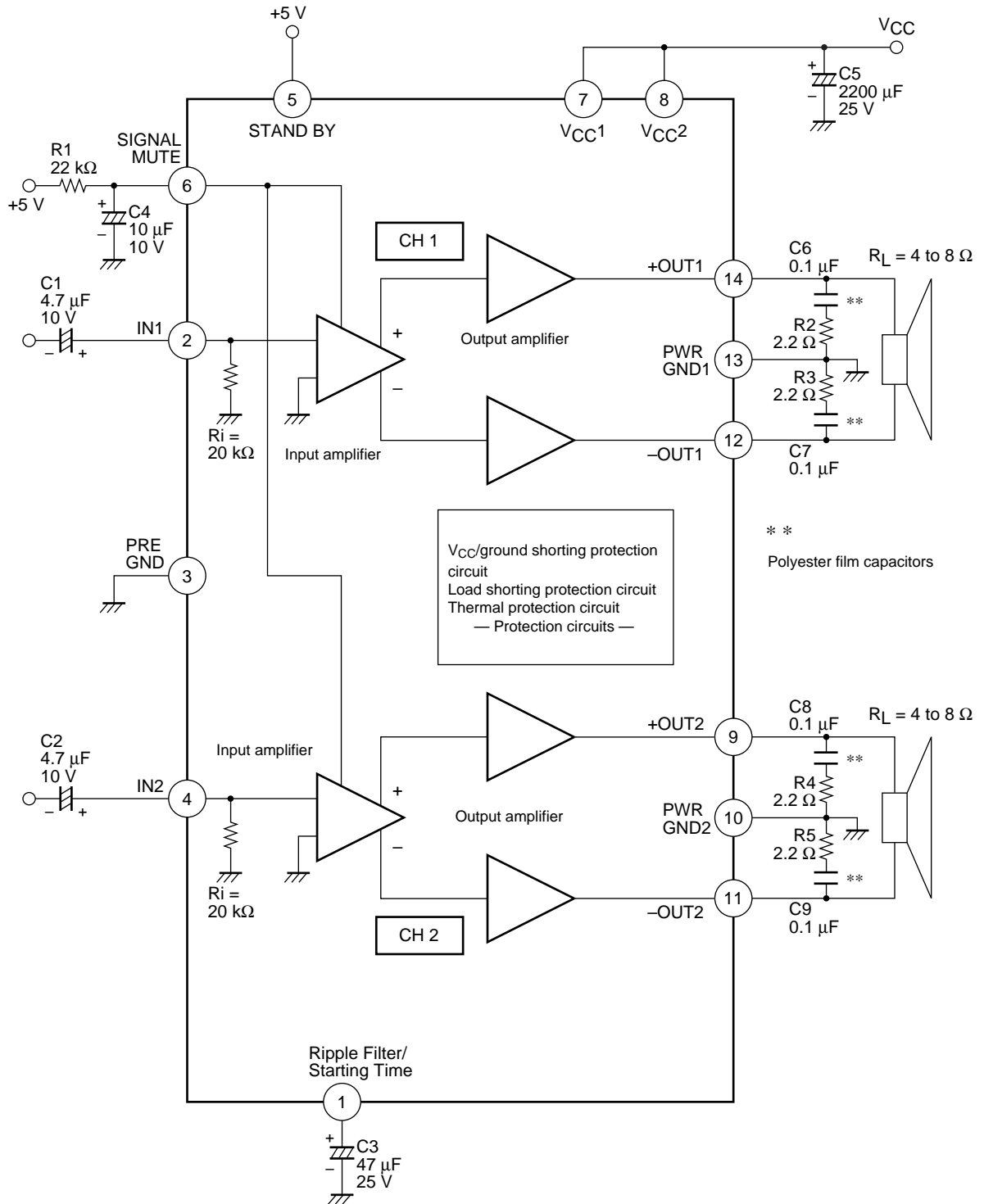

A10630

Pin Voltages at $V_{CC} = 15\text{ V}$, with 5 V applied to the STBY pin (pin 5), using a digital volt meter.

Pin No.	1	2	3	4	5	6	7
Pin	RF	IN1	PRE-GND	IN2	STAND-BY	MUTE	V_{CC1}
Pin voltage (V)	14.32	3 m	0	3 m	5	21m	15

Pin No.	8	9	10	11	12	13	14
Pin	V_{CC2}	+OUT2	PWR-GND2	-OUT2	-OUT1	PWR-GND1	+OUT1
Pin voltage (V)	15	6.84	0	6.84	6.84	0	6.84

External Components

C1 and C2

- These are input coupling capacitors, and we recommend that values under $4.7\ \mu\text{F}$ be used. The LA4663 uses a zero bias type input circuit, and the input pin potential is about zero volts. Determine the polarity orientation of these capacitors based on the DC current from the circuit connected to the LA4663 front end.

If the potential difference between across the + and – leads on the input capacitors is large, the charge time for the input capacitors can be reduced by using as small a value as possible without causing degradation of the low band frequency characteristics. This will shorten the time required to reach stable operation when power is first applied.

C3 *1

- This capacitor functions both as a ripple filter and as the amplifier starting time capacitor. We recommend a value of $47\ \mu\text{F}$. When the recommended value is used, the BTL SVRR between outputs will be about 63 dB, and that between the outputs and ground will be about 47 dB. (These are values are for reference purposes.) Similarly, the starting time (the time between the point power is first applied and the point an output is generated) will be around 0.6 to 0.7 seconds.

C4 and R1 *2

- These form an CR circuit used for muting function smoothing. C4 is required even if the muting function is not used.

C5

- Power supply capacitor

C6 to C9 and R2 to R5

- These components for oscillation prevention CR circuits. We recommend the use of polyester film capacitors (Mylar capacitors) with excellent temperature characteristics for C6 through C9. (R2 to R5 should all be $2.2\text{-}\Omega$ 1/4-W resistors.)

Notes: 1. Starting time

- The LA4663 includes a built-in starting time circuit. The starting time can be varied somewhat by modifying the value of the external capacitor connected to pin 1. With the recommended value of $47\ \mu\text{F}$, the starting time will be between 0.6 and 0.7 second (although this will vary with the supply voltage, V_{CC}) and this time can be lengthened to about 0.9 second by inserting a $10\ \mu\text{F}$ capacitor in parallel.
- We do not recommend using a value smaller than the recommended value for the pin 1 capacitor, since that could result in reducing the SVRR with respect to ground.

2. Signal muting function

- When the recommended CR circuit ($10\ \mu\text{F}$ and $22\ \text{k}\Omega$) is connected to pin 6, the signal muting function can be turned on, and a muting function with minimal impulse noise applied by applying a voltage of 5V.
- The CR circuit determines the attack and recovery times for smoothing function. Note that this $10\text{-}\mu\text{F}$ capacitor is required even when the signal muting function is not used, since it is also used for smoothing after the starting time has elapsed. The influx current to pin 6 when this external resistor has a value of

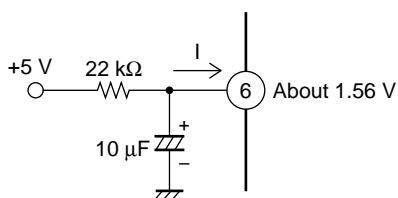

A10631

$22\ \text{k}\Omega$ will be about $170\ \mu\text{A}$ when the applied voltage is +5 V. Although it is possible to modify the value of this resistor if a different applied voltage or if the capacity of the microcontroller required it, it is possible for the level of the impulse noise associated with the muting function to increase if the pin 6 influx current becomes excessive. Be sure to take this influx current into account if the value of this resistor is modified.

Other Notes

- Standby function

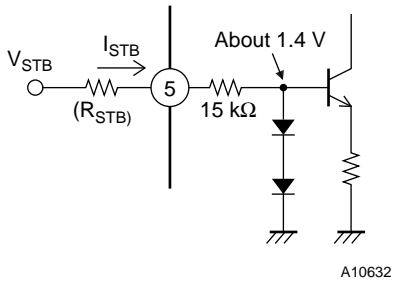

Pin 5 in this IC is the standby pin, and applying a voltage of 2.0 V or higher will activate this function. The pin 5 influx current for an applied voltage of 5 V will be about 240 μA.

$$I_{STB} = \frac{5\text{ V} - 1.4\text{ V}}{15\text{ k}} = 240\ \mu\text{A}$$

Insert an external current limiting resistor (R_{STB}) if it is necessary to limit this influx current when using a microcontroller.

If this input voltage is applied by a circuit or device other than a microcontroller, calculate the value for R_{STB} from the following formula such that the pin 5 influx current due to the applied V_{STB} is under 500 μA.

$$R_{STB} = \frac{\text{Applied voltage (V}_{STB}) - 1.4\text{ V}}{500\ \mu\text{A}} - 15\text{ k}\Omega$$

Sample Printed Circuit Board Pattern (Copper surface)

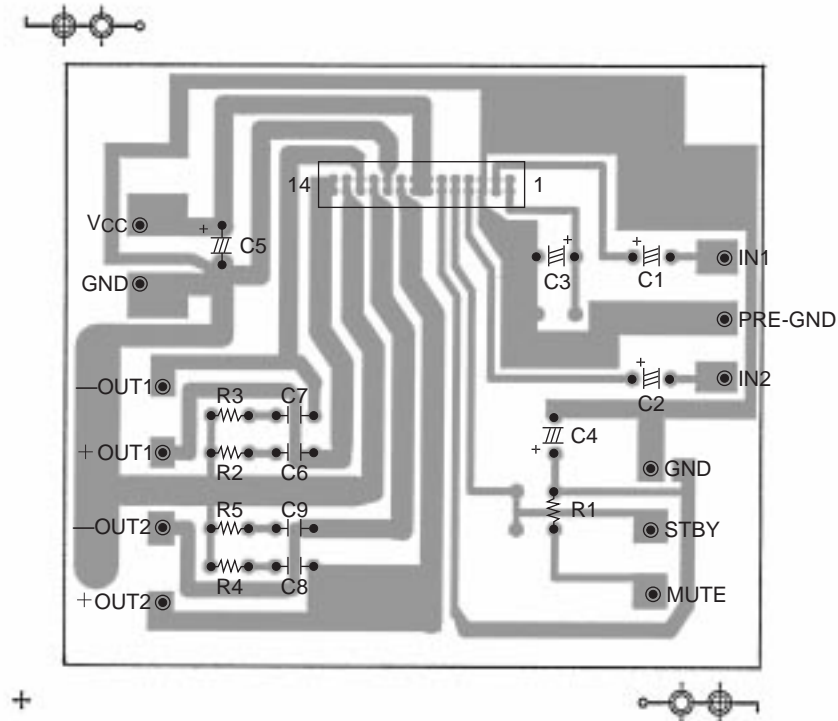

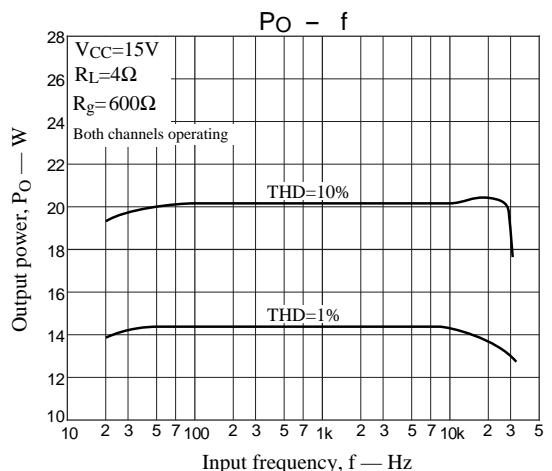
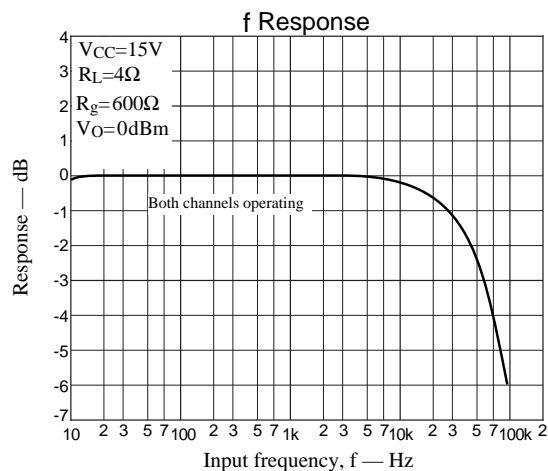
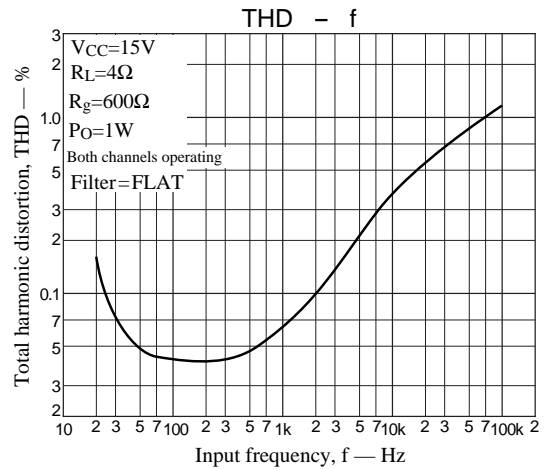
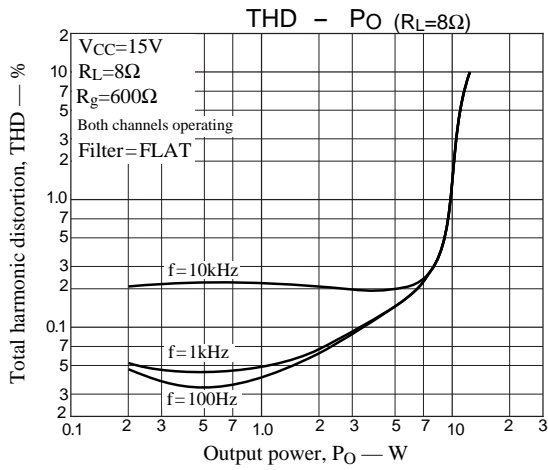
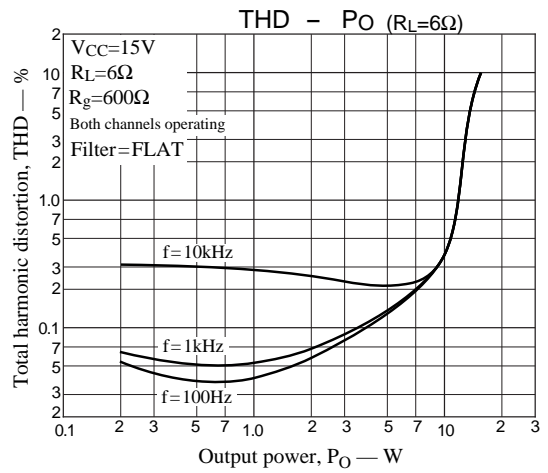
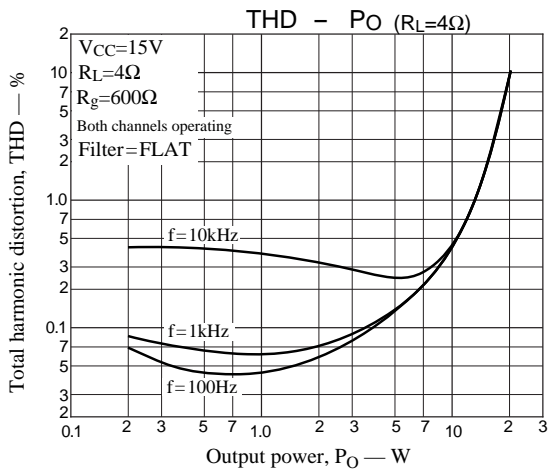
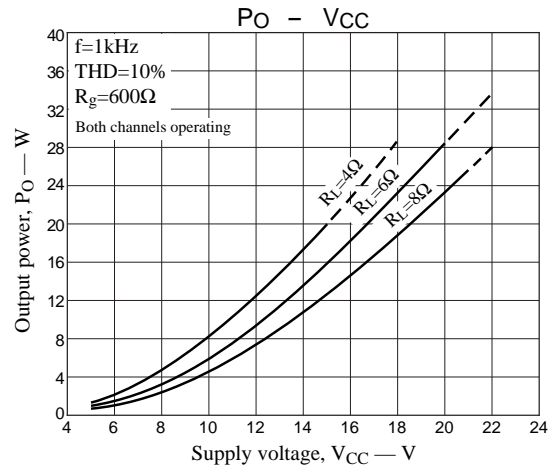
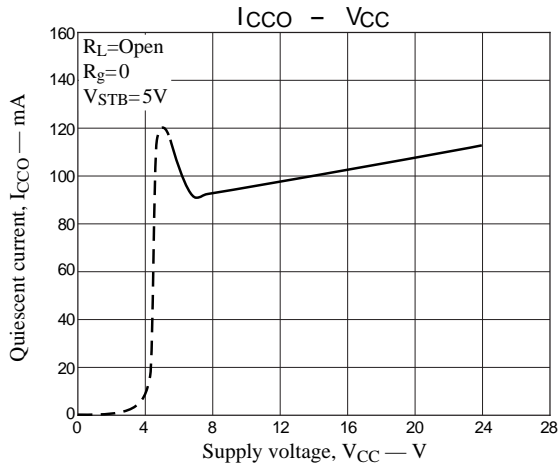

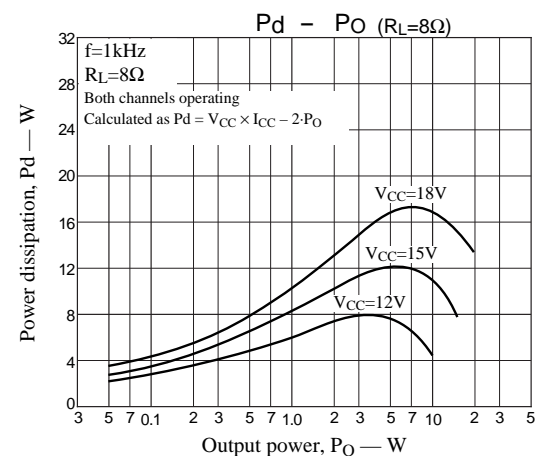
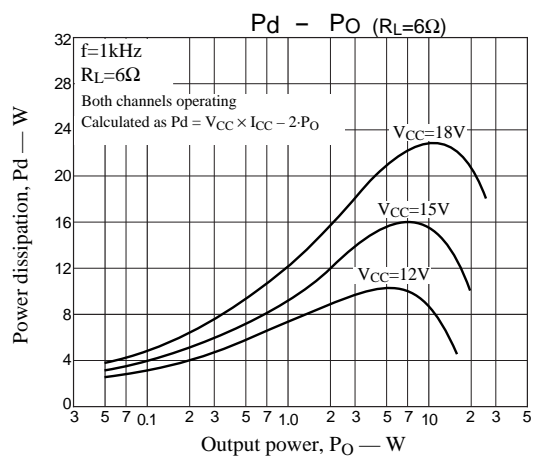
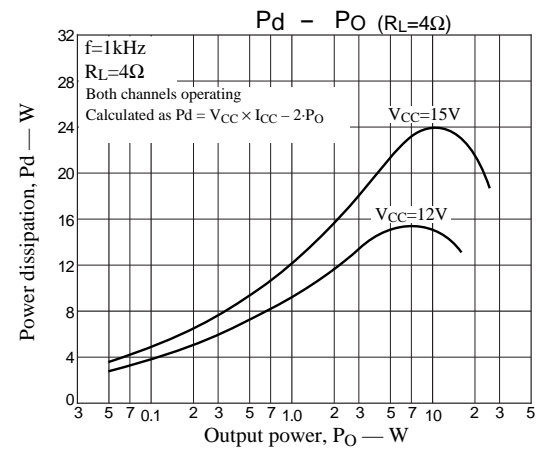
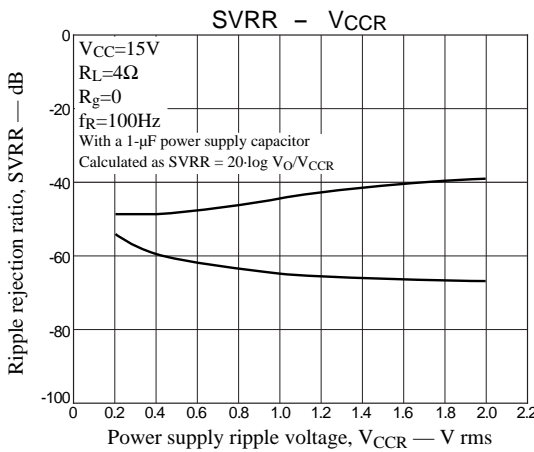
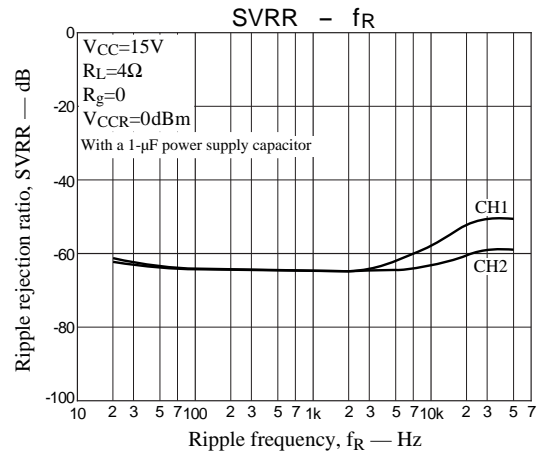
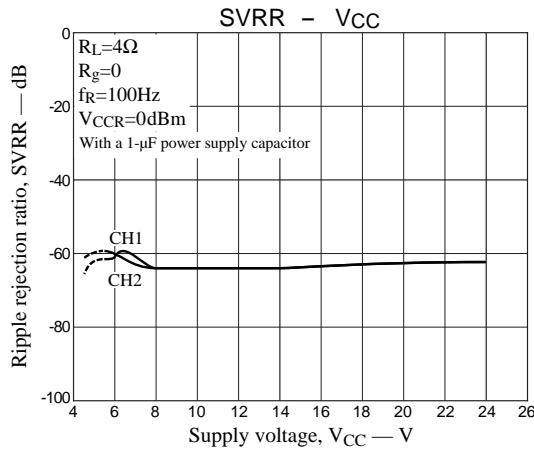
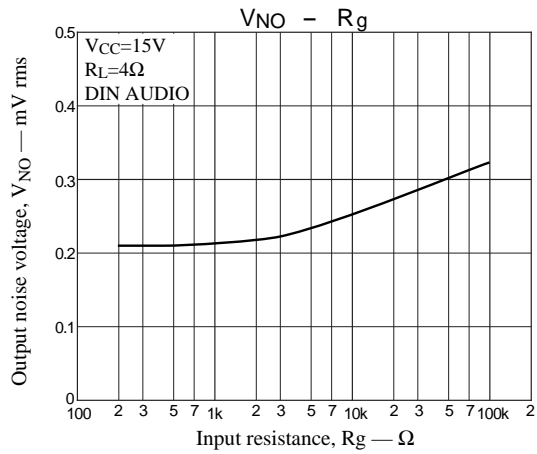
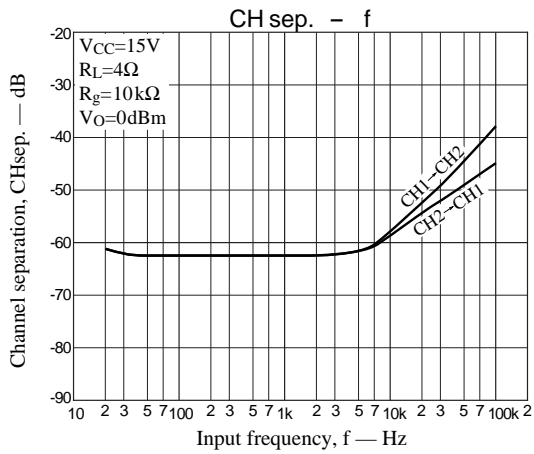

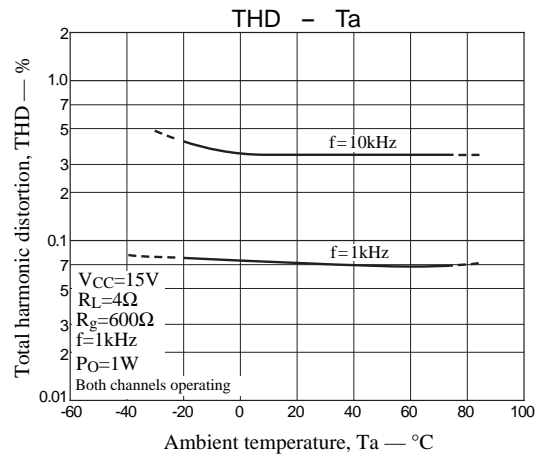
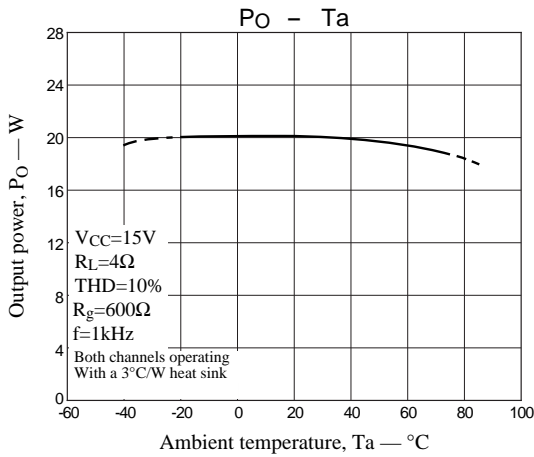
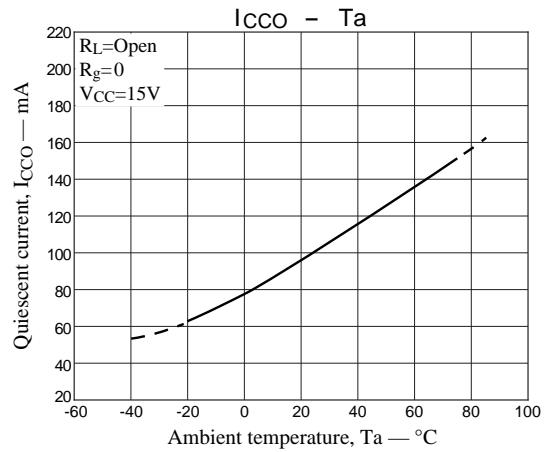
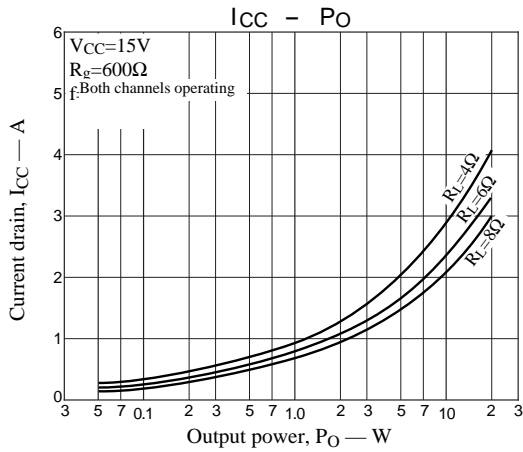

- Specifications of any and all SANYO products described or contained herein stipulate the performance, characteristics, and functions of the described products in the independent state, and are not guarantees of the performance, characteristics, and functions of the described products as mounted in the customer's products or equipment. To verify symptoms and states that cannot be evaluated in an independent device, the customer should always evaluate and test devices mounted in the customer's products or equipment.
- SANYO Electric Co., Ltd. strives to supply high-quality high-reliability products. However, any and all semiconductor products fail with some probability. It is possible that these probabilistic failures could give rise to accidents or events that could endanger human lives, that could give rise to smoke or fire, or that could cause damage to other property. When designing equipment, adopt safety measures so that these kinds of accidents or events cannot occur. Such measures include but are not limited to protective circuits and error prevention circuits for safe design, redundant design, and structural design.
- In the event that any or all SANYO products (including technical data, services) described or contained herein are controlled under any of applicable local export control laws and regulations, such products must not be exported without obtaining the export license from the authorities concerned in accordance with the above law.
- No part of this publication may be reproduced or transmitted in any form or by any means, electronic or mechanical, including photocopying and recording, or any information storage or retrieval system, or otherwise, without the prior written permission of SANYO Electric Co., Ltd.
- Any and all information described or contained herein are subject to change without notice due to product/technology improvement, etc. When designing equipment, refer to the "Delivery Specification" for the SANYO product that you intend to use.
- Information (including circuit diagrams and circuit parameters) herein is for example only; it is not guaranteed for volume production. SANYO believes information herein is accurate and reliable, but no guarantees are made or implied regarding its use or any infringements of intellectual property rights or other rights of third parties.

This catalog provides information as of April, 2000. Specifications and information herein are subject to change without notice.

This datasheet has been download from:

www.datasheetcatalog.com

Datasheets for electronics components.