

Power Schottky rectifier

Datasheet – production data

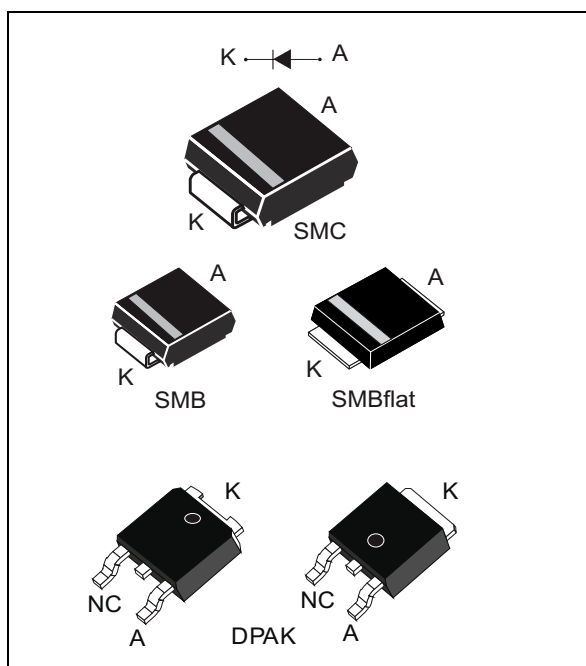

Description

Single chip Schottky rectifier suited for switch mode power supplies and high frequency DC to DC converters.

Packaged in DPAK, SMC, SMB, and SMBflat, this device is intended for use in low and medium voltage operation, high frequency inverters, free wheeling and polarity protection applications where low switching losses are required.

Table 1. Device summary

Symbol	Value
$I_{F(AV)}$	3 A
V_{RRM}	40 V
$T_{j(max)}$	150 °C
$V_F (Typ)$	0.52 V

Features

- Very small conduction losses
- Negligible switching losses
- Low forward voltage drop
- Low thermal resistance
- Extremely fast switching
- Surface mounted device
- Avalanche capability specified
- ECOPACK[®]2 compliant component for DPAK on demand

1 Characteristics

Table 2. Absolute ratings (limiting values at T_{amb} = 25 °C unless otherwise specified)

Symbol	Parameter		Value	Unit	
V _R RM	Repetitive peak reverse voltage		40	V	
I _F (RMS)	Forward rms current	DPAK	6	A	
I _F (AV)	Average forward current, δ = 0.5, square wave	T _c = 135 °C	DPAK	3	A
		T _l = 105 °C	SMC		
		T _l = 95 °C	SMB		
		T _l = 115 °C	SMBflat		
I _F SM	Surge non repetitive forward current	t _p = 10 ms sinusoidal	75	A	
P _{ARM} ⁽¹⁾	Repetitive peak avalanche power	t _p = 10 μs, T _j = 125 °C	90	W	
T _{stg}	Storage temperature range		-65 to +150	°C	
T _j	Maximum operating junction temperature ⁽²⁾		150	°C	

- For pulse time duration derating, please refer to [Figure 4](#). More details regarding the avalanche energy measurements and diode validation in the avalanche are provided in the application notes AN1768 and AN2025.
- $\frac{dP_{tot}}{dT_j} < \frac{1}{R_{th(j-a)}}$ condition to avoid thermal runaway for a diode on its own heatsink

Table 3. Thermal parameters

Symbol	Parameter		Max. value	Unit
R _{th(j-l)}	Junction to lead	SMC	20	°C/W
		SMB	25	
		SMBflat	15	
R _{th(j-c)}	Junction to case	DPAK	5.5	

Table 4. Static electrical characteristics

Symbol	Parameter	Test conditions		Min.	Typ	Max.	Unit
I _R ⁽¹⁾	Reverse leakage current	T _j = 25 °C	V _R = V _{RRM}	-		20	μA
		T _j = 125 °C		-	2	10	mA
V _F ⁽¹⁾	Forward voltage drop	T _j = 25 °C	I _F = 3 A	-		0.63	V
		T _j = 125 °C		-	0.52	0.57	
		T _j = 25 °C	I _F = 6 A	-		0.84	
		T _j = 125 °C		-	0.63	0.72	

- Pulse test: t_p = 380 μs, δ < 2%

To evaluate the conduction losses, use the following equation:

$$P = 0.42 \times I_{F(AV)} + 0.050 \times I_{F(RMS)}^2$$

Figure 1. Average forward power dissipation versus average forward current

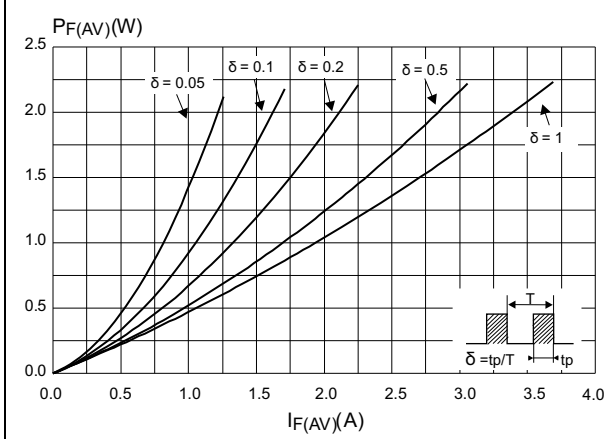

Figure 2. Average forward current versus ambient temperature ($\delta = 0.5$)(DPAK, SMB, SMC)

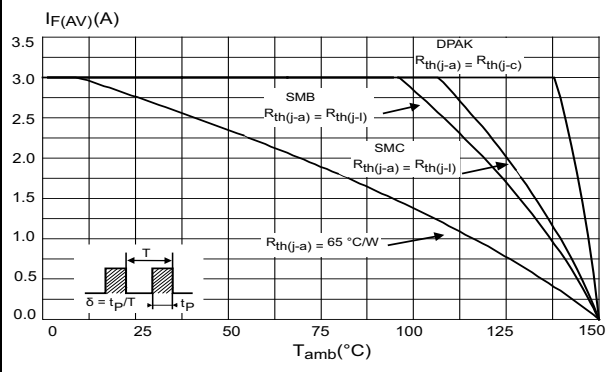

Figure 3. Average forward current versus ambient temperature ($\delta = 0.5$) (SMBflat)

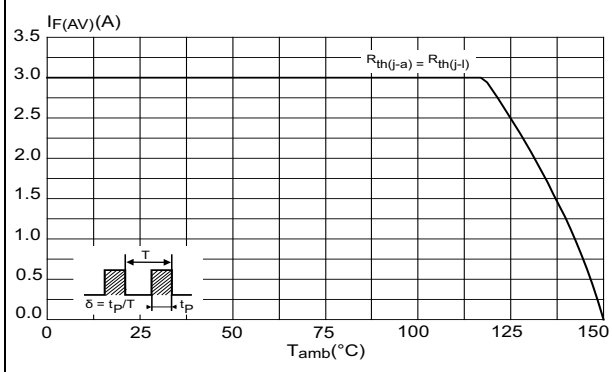

Figure 4. Normalized avalanche power derating versus pulse duration ($T_j = 125^\circ\text{C}$)

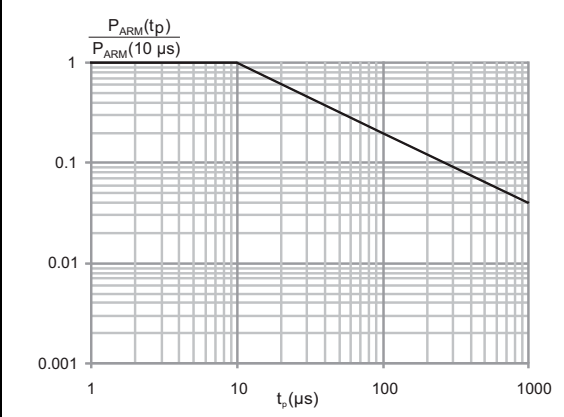

Figure 5. Relative variation of thermal impedance junction to case versus pulse duration (DPAK)

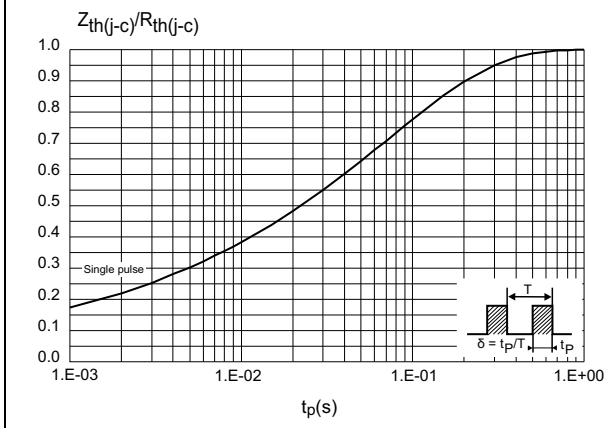

Figure 6. Relative variation of thermal impedance junction to ambient versus pulse duration (SMB)

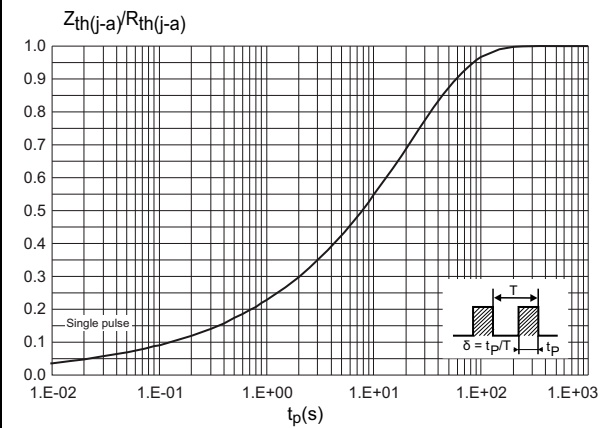

Figure 7. Relative variation of thermal impedance junction to ambient versus pulse duration (SMC)

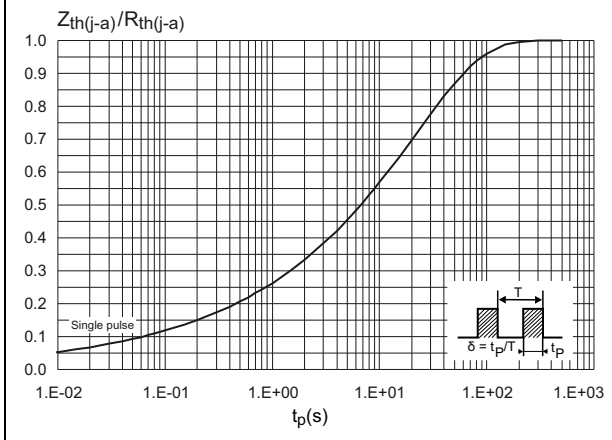

Figure 8. Relative variation of thermal impedance junction to lead versus pulse duration (SMBflat)

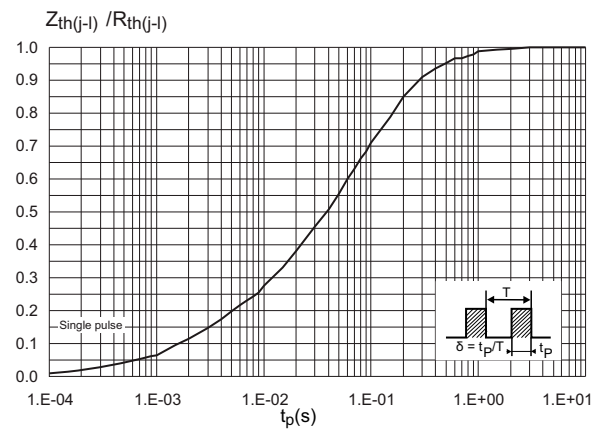

Figure 9. Reverse leakage current versus reverse voltage applied (typical values)

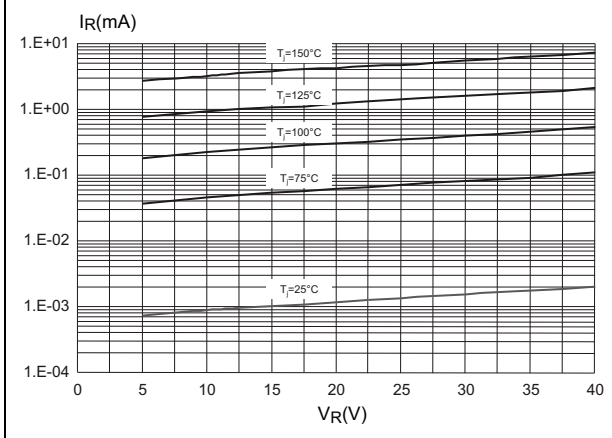

Figure 10. Junction capacitance versus reverse voltage applied (typical values)

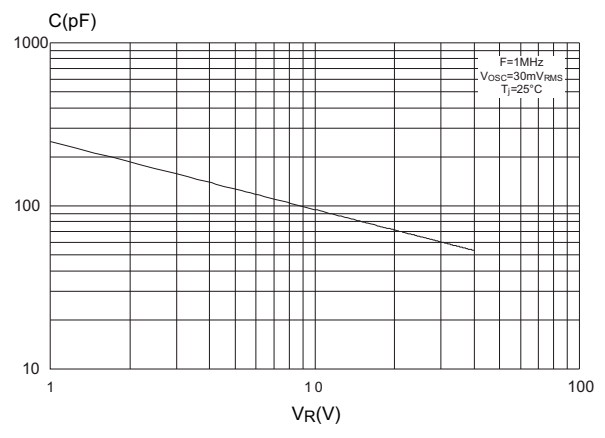

Figure 11. Forward voltage drop vs. forward current

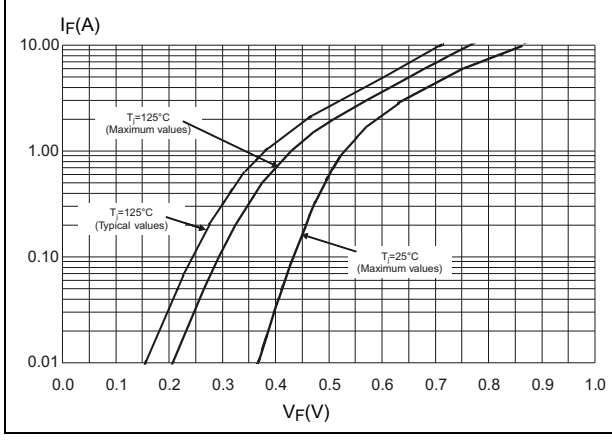

Figure 12. Thermal resistance junction to ambient versus copper surface under tab

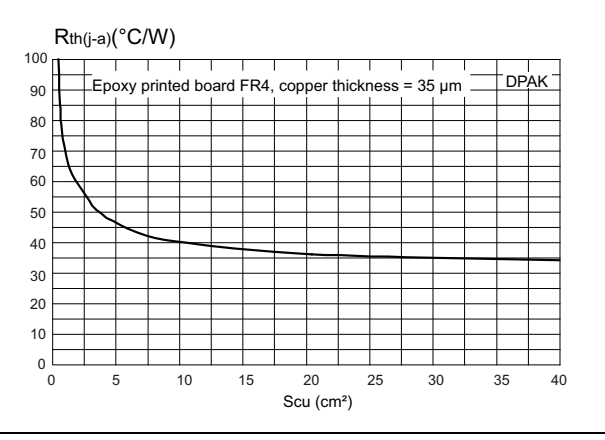

Figure 13. Thermal resistance junction to ambient versus copper surface under each lead

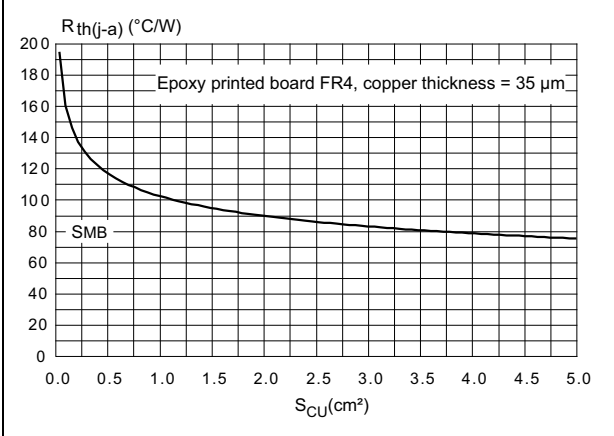

Figure 14. Thermal resistance junction to ambient versus copper surface under each lead

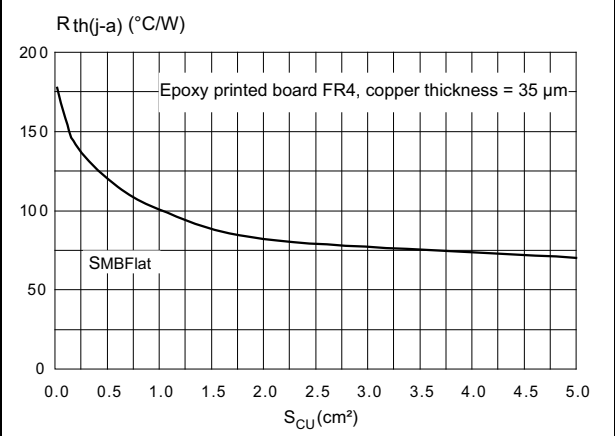
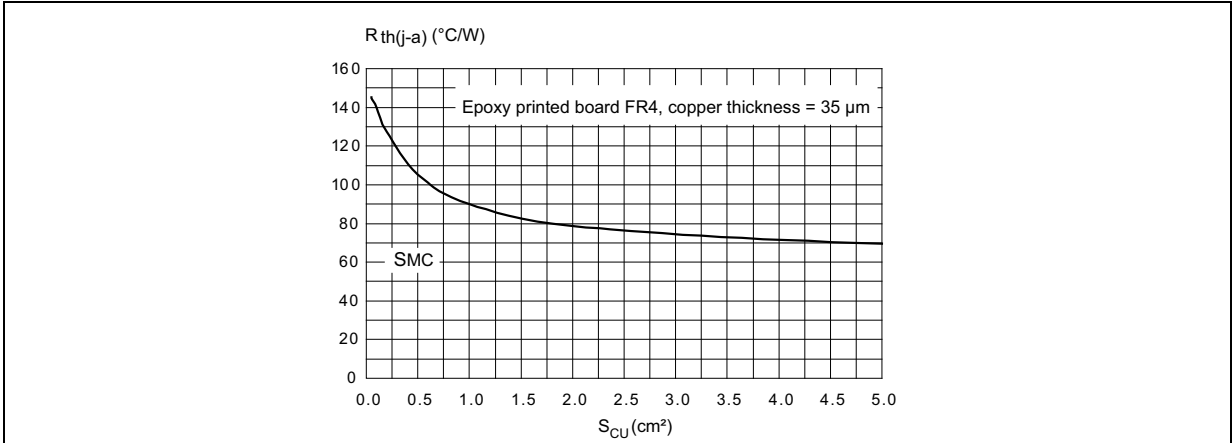

Figure 15. Thermal resistance junction to ambient versus copper surface under each lead



2 Package Information

- Epoxy meets UL94,V0
- Cooling method: by conduction (C)
- Band indicates cathode (SMB, SMBflat, SMC)

In order to meet environmental requirements, ST offers these devices in different grades of ECOPACK® packages, depending on their level of environmental compliance. ECOPACK® specifications, grade definitions and product status are available at: www.st.com. ECOPACK® is an ST trademark.

2.1 DPAK package information

Figure 16. DPAK package outline

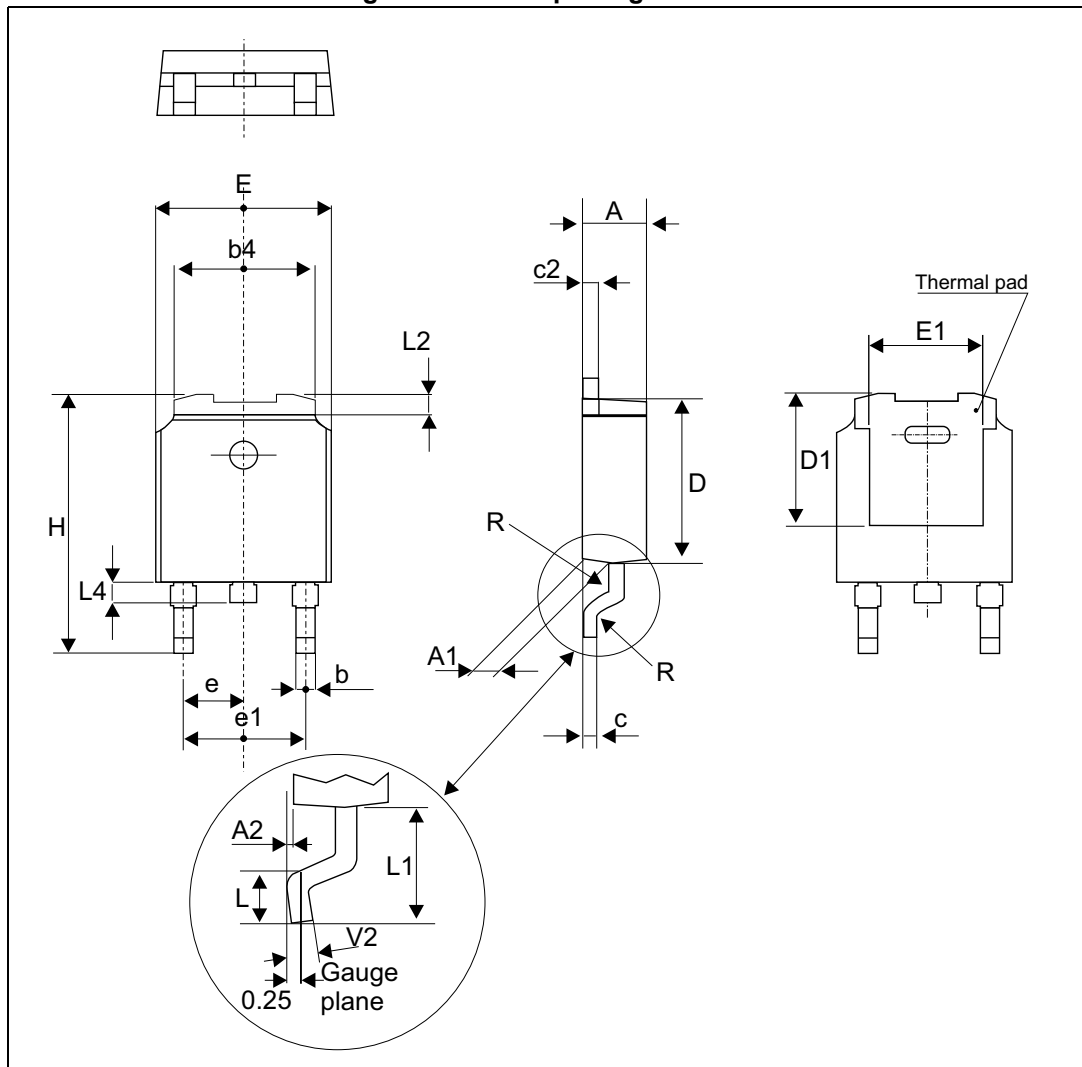

Note: This package drawing may slightly differ from the physical package. However, all the specified dimensions are guaranteed.

Table 5. DPAK package mechanical data

Ref.	Dimensions					
	Millimeters			Inches		
	Min.	Typ.	Max.	Min.	Typ.	Max.
A	2.18		2.40	0.085		0.094
A1	0.90		1.10	0.035		0.043
A2	0.03		0.23	0.001		0.009
b	0.64		0.90	0.025		0.035
b4	4.95		5.46	0.194		0.214
c	0.46		0.61	0.018		0.024
c2	0.46		0.60	0.018		0.023
D	5.97		6.22	0.235		0.244
D1	4.95		5.60	0.194		0.220
E	6.35		6.73	0.250		0.264
E1	4.32		5.50	0.170		0.216
e		2.28			0.090	
e1	4.40		4.70	0.173		0.185
H	9.35		10.40	0.368		0.409
L	1.00		1.78	0.039		0.070
L2			1.27			0.050
L4	0.60		1.02	0.023		0.040
V2	-8°		+8°	-8°		8°

Figure 17. DPAK footprint dimensions (in mm)

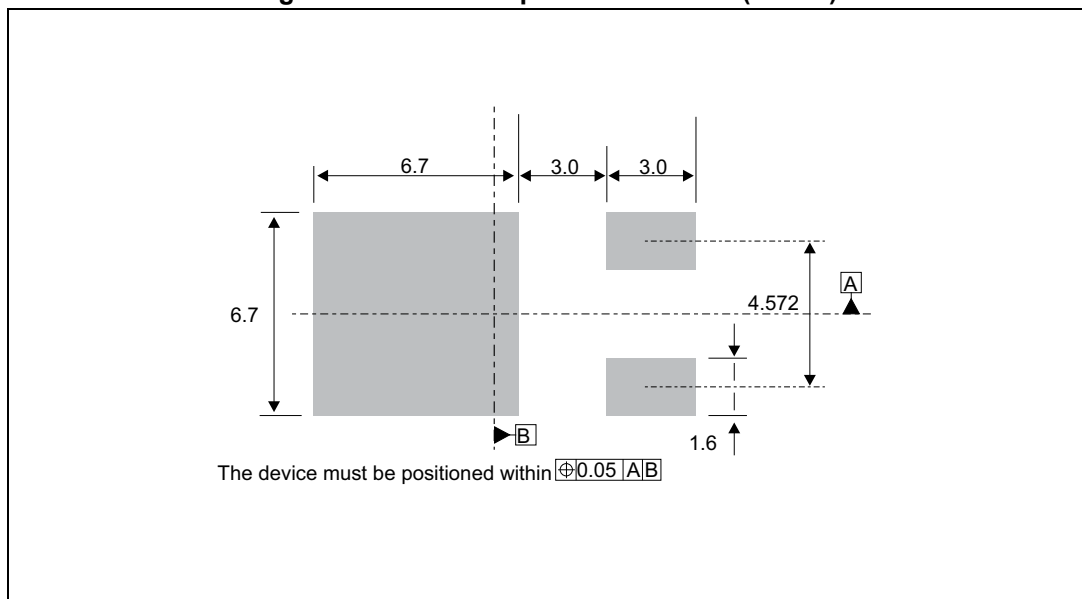

2.2 SMBflat package information

Figure 18. SMBflat package outline

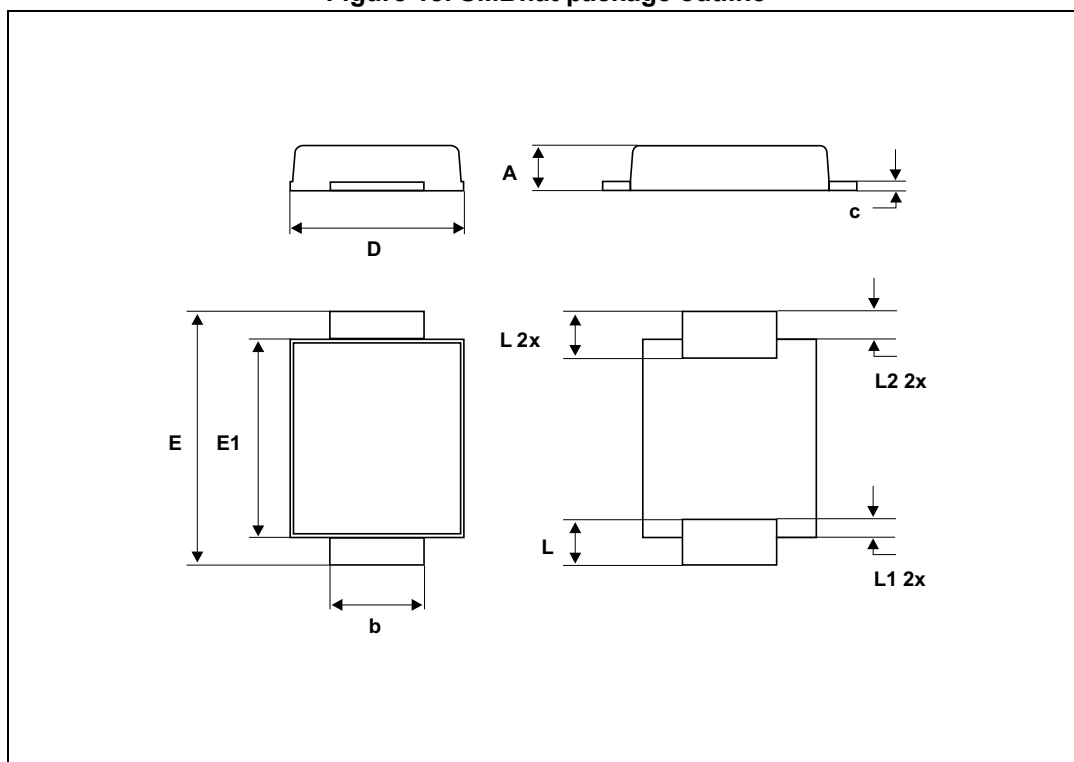
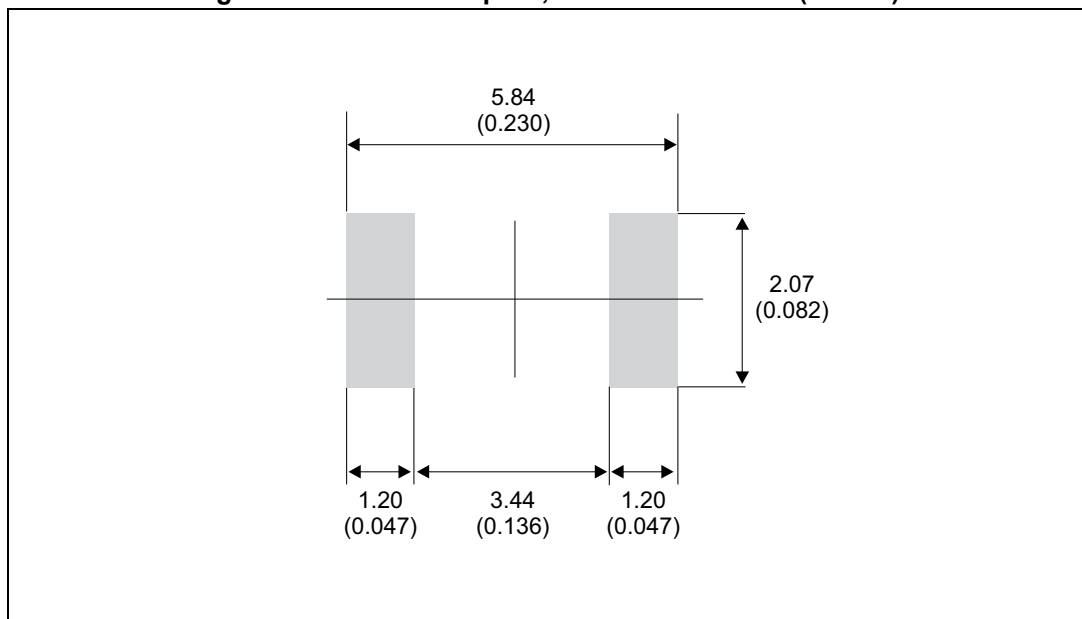

Table 6. SMBflat package mechanical data

Ref.	Dimensions					
	Millimeters			Inches		
	Min.	Typ.	Max.	Min.	Typ.	Max.
A	0.90		1.10	0.035		0.043
b	1.95		2.20	0.077		0.087
c	0.15		0.40	0.006		0.016
D	3.30		3.95	0.130		0.155
E	5.10		5.60	0.200		0.220
E1	4.05		4.60	0.159		0.181
L	0.75		1.50	0.029		0.059
L1		0.40			0.016	
L2		0.60			0.024	

Figure 19. SMBflat footprint, dimensions in mm (inches)



2.3 SMB package information

Figure 20. SMB package outline

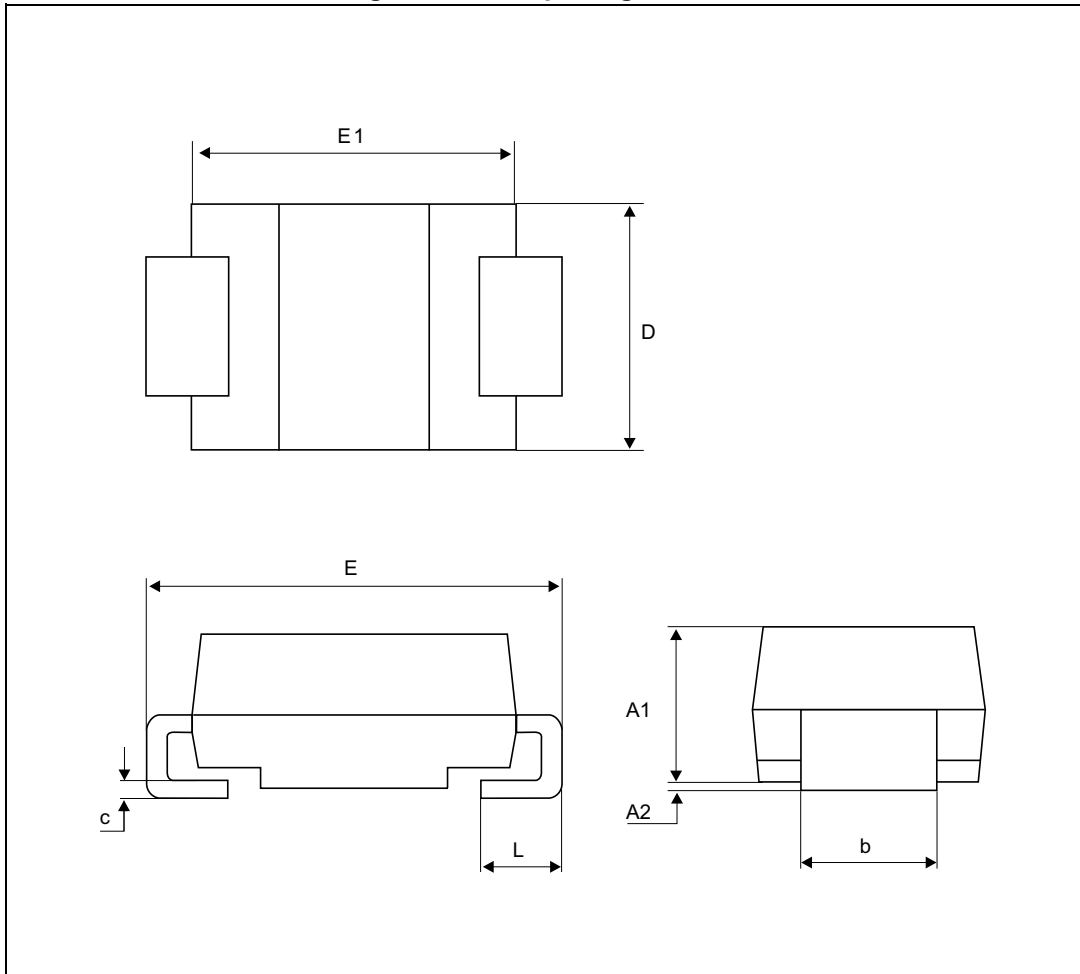
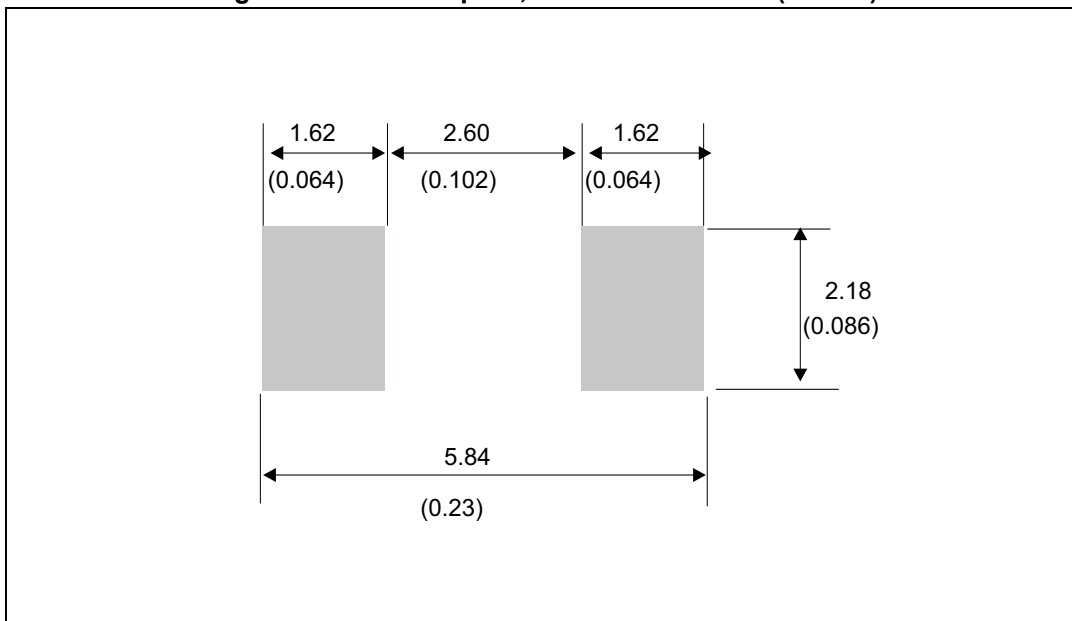

Table 7. SMB package mechanical data

Ref.	Dimensions			
	Millimeters		Inches	
	Min.	Max.	Min.	Max.
A1	1.90	2.45	0.075	0.096
A2	0.05	0.20	0.002	0.008
b	1.95	2.20	0.077	0.087
c	0.15	0.40	0.006	0.016
D	3.30	3.95	0.130	0.156
E	5.10	5.60	0.201	0.220
E1	4.05	4.60	0.159	0.181
L	0.75	1.50	0.030	0.059

Figure 21. SMB footprint, dimensions in mm (inches)



2.4 SMC package information

Figure 22. SMC package outline

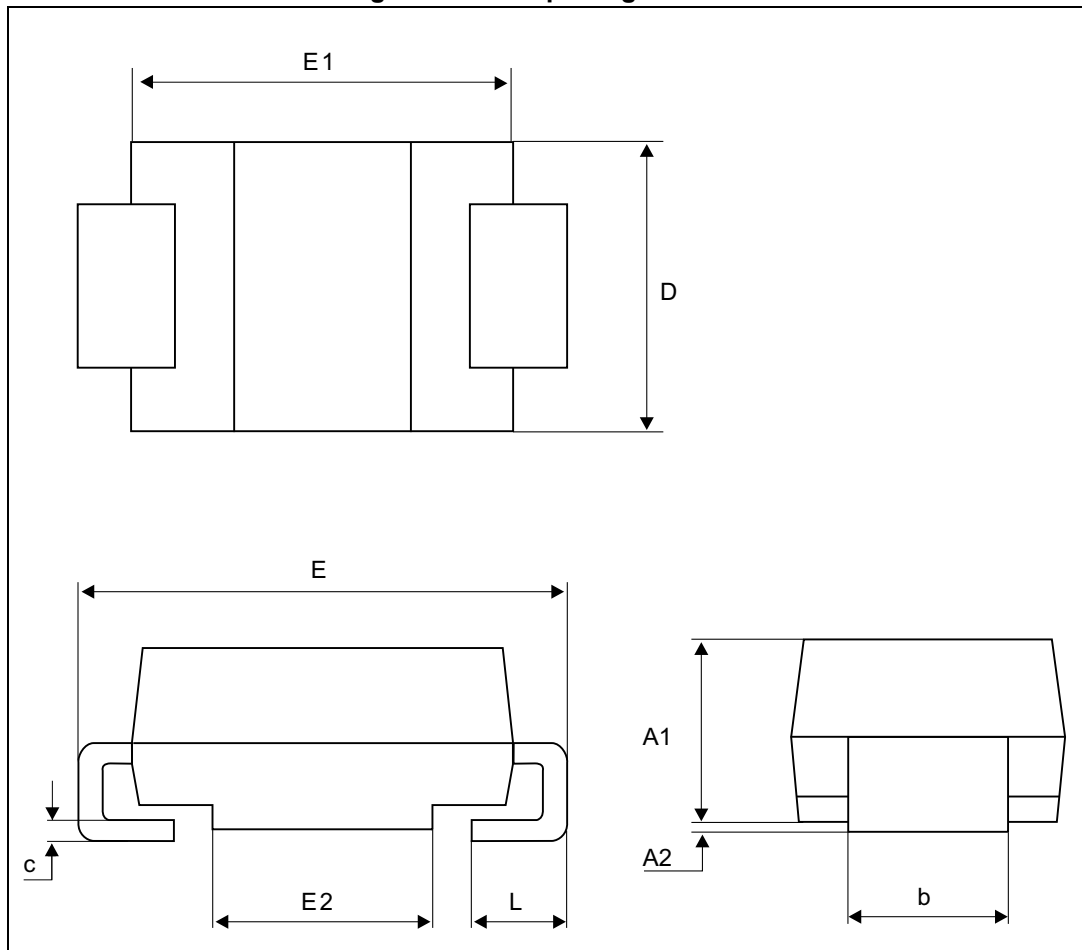
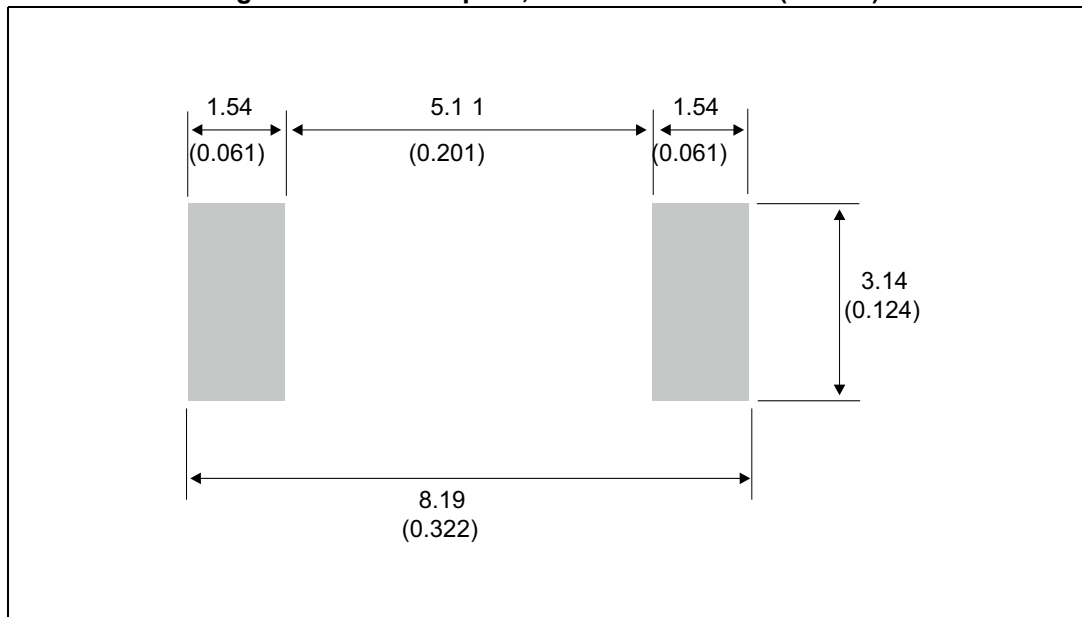

Table 8. SMC package mechanical data

Ref.	Dimensions			
	Millimeters		Inches	
	Min.	Max.	Min.	Max.
A1	1.90	2.45	0.075	0.096
A2	0.05	0.20	0.002	0.008
b ⁽¹⁾	2.90	3.20	0.114	0.126
c ⁽¹⁾	0.15	0.40	0.006	0.016
D	5.55	6.25	0.218	0.246
E	7.75	8.15	0.305	0.321
E1	6.60	7.15	0.260	0.281
E2	4.40	4.70	0.173	0.185
L	0.75	1.50	0.030	0.059

1. Dimensions b and c apply to plated leads

Figure 23. SMC footprint, dimensions in mm (inches)



3 Ordering information

Table 9. Ordering information

Order code	Marking	Package	Weight	Base qty	Delivery mode
STPS340U	U34	SMB	107 mg	2500	Tape and reel
STPS340S	S34	SMC	243 mg		
STPS340B-TR	S3 40	DPAK	320 mg		
STPS340UF	FU34	SMBflat	50 mg	5000	

4 Revision history

Table 10. Revision history

Date	Revision	Changes
Jul-2003	7	Last update.
Feb-2005	8	Layout update. No content change.
08-Feb-2007	9	Reformatted to current standard. Added ECOPACK statement. Added SMBflat package.
10-Feb-2009	10	Updated ECOPACK statement. Corrected Y axis in Figure 10.
23-Apr-2015	11	Updated DPAK and reformatted to current standard.
22-Sep-2016	12	Updated DPAK package information and reformatted to current standard.

IMPORTANT NOTICE – PLEASE READ CAREFULLY

STMicroelectronics NV and its subsidiaries ("ST") reserve the right to make changes, corrections, enhancements, modifications, and improvements to ST products and/or to this document at any time without notice. Purchasers should obtain the latest relevant information on ST products before placing orders. ST products are sold pursuant to ST's terms and conditions of sale in place at the time of order acknowledgement.

Purchasers are solely responsible for the choice, selection, and use of ST products and ST assumes no liability for application assistance or the design of Purchasers' products.

No license, express or implied, to any intellectual property right is granted by ST herein.

Resale of ST products with provisions different from the information set forth herein shall void any warranty granted by ST for such product.

ST and the ST logo are trademarks of ST. All other product or service names are the property of their respective owners.

Information in this document supersedes and replaces information previously supplied in any prior versions of this document.

© 2016 STMicroelectronics – All rights reserved