

## 20A SCHOTTKY BARRIER DIODE

### Full Pack High Voltage Schottky Rectifier

#### Specification Features:

- High Voltage Wide Range Selection, 100V, 150V & 200V
- High Switching Speed Device
- Low Forward Voltage Drop
- Low Power Loss and High Efficiency
- Guard Ring for Over-voltage Protection
- High Surge Capability
- RoHS Compliant
- Matte Tin(Sn) Lead Finish
- Terminal Leads Surface is Corrosion Resistant and can withstand to 260°C Wave Soldering or per MIL-STD-750, Method 2026.

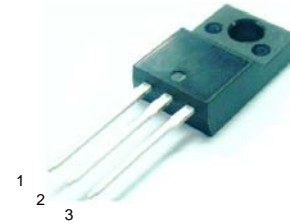

TO-220FP

#### DEVICE MARKING DIAGRAM



L = Tak Cheong Logo  
 xxyy = Monthly Date Code  
 Line 2 = MBRF  
 Line 3 = 20xxxCT  
 Line 4 = Polarity

#### POLARITY CONFIGURATION

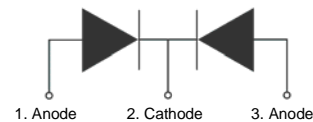

#### MAXIMUM RATINGS (Per Leg, unless otherwise specified)

Symbol	Parameter	MBRF20100CT	MBRF20150CT	MBRF20200CT	Units
$V_{RRM}$ $V_{RWM}$ $V_R$	Maximum Repetitive Reverse Voltage Working Peak Reverse Voltage Maximum DC Reverse Voltage	100	150	200	V
$I_{F(AV)}$	Average Rectified Forward Current Per Leg Per Package		10 20		A
$I_{FSM}$	Non-repetitive Peak Forward Surge Current 8.3mS Single Phase @ Rated Load		150		A
$T_{STG}$	Storage Temperature Range		-65 to +150		°C
$T_J$	Operating Junction Temperature		+150		°C

These ratings are limiting values above which the serviceability of the diode may be impaired.

#### THERMAL CHARACTERISTICS

$T_A = 25^\circ\text{C}$  unless otherwise noted

Symbol	Parameter	Value	Units
$R_{\theta JC}$	Maximum Thermal Resistance, Junction-to-Case	2.0	°C/W
$R_{\theta JA}$	Maximum Thermal Resistance, Junction-to-Ambient (per leg)	60	°C/W

#### ELECTRICAL CHARACTERISTICS (Per Diode)

$T_A = 25^\circ\text{C}$  unless otherwise noted

Symbol	Parameter	Test Condition (Note 1)	MBRF20100CT		MBRF20150CT		MBRF20200CT		Units
			Min	Max	Min	Max	Min	Max	
$I_R$	Reverse Current	@ rated $V_R$	---	200	---	200	---	200	$\mu\text{A}$
$V_F$	Forward Voltage	$I_F = 10\text{A}$	---	0.85	---	0.92	---	1.00	V
		$I_F = 20\text{A}$	---	0.95	---	1.00	---	1.25	

Note/s:

1. Tested under pulse condition of 300 $\mu\text{s}$ .

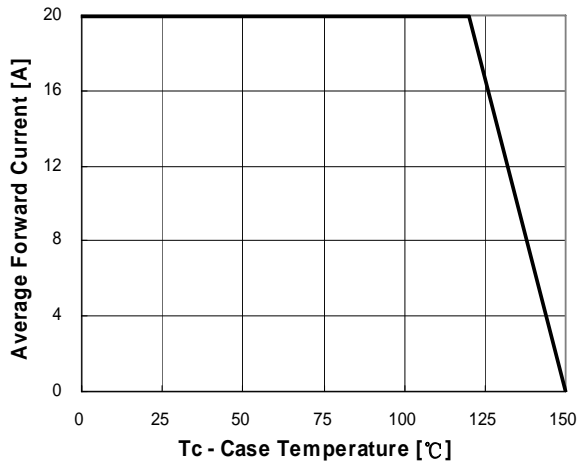
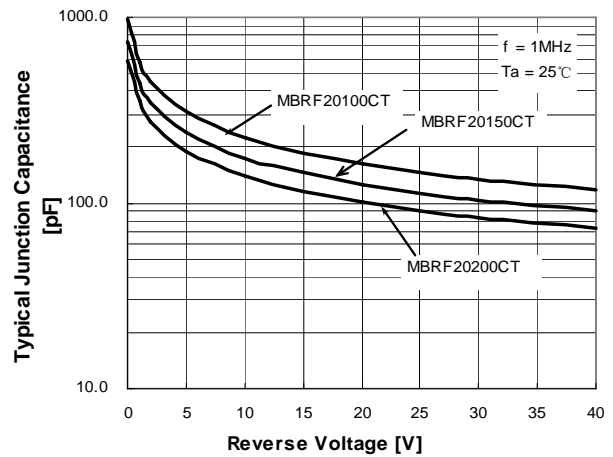
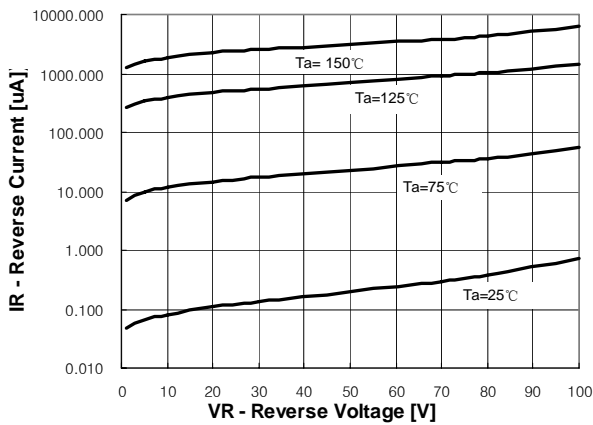
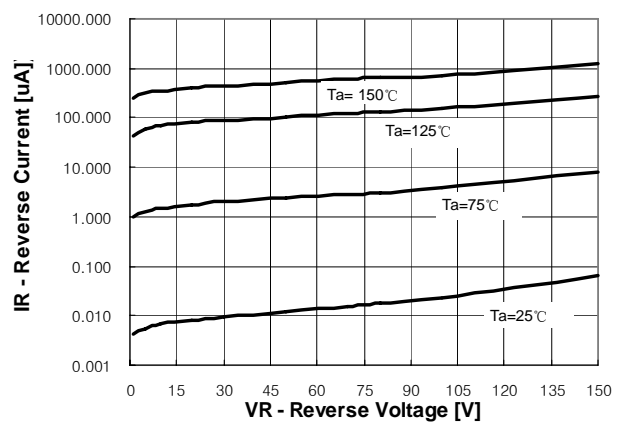
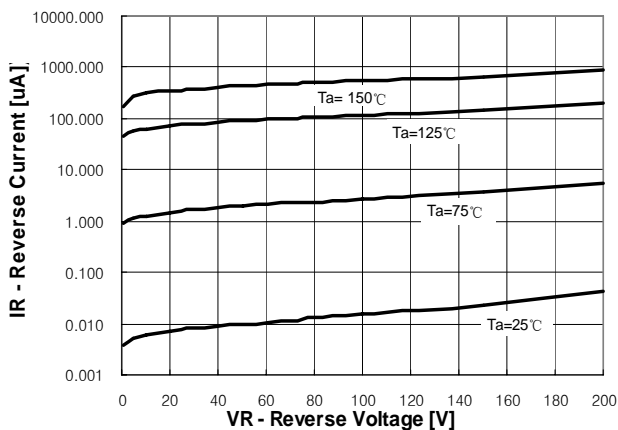
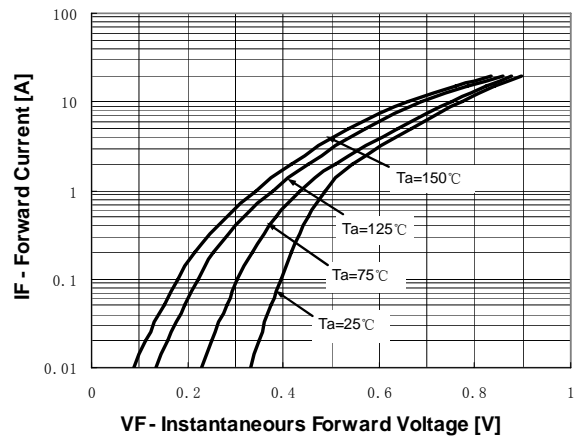
**TYPICAL CHARACTERISTICS**
**Figure 1. Forward Current Derating Curve (Per Diode)**

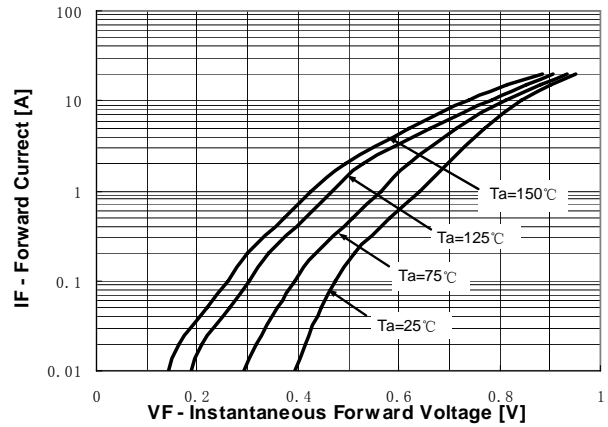
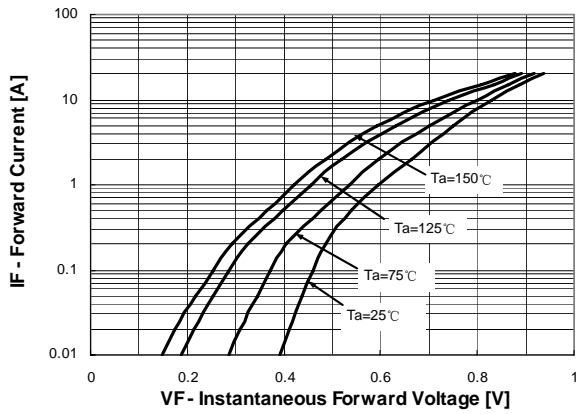
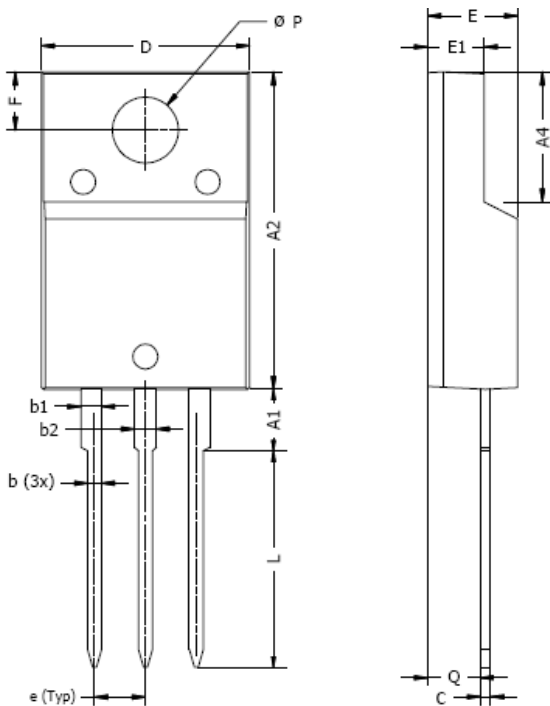
**Figure 2. Junction Capacitance (Per Diode)**

**Figure 3. MBRF20100CT Typical Reverse Current (Per Diode)**

**Figure 4. MBRF20150CT Typical Reverse Current (Per Diode)**

**Figure 5. MBRF20200CT Typical Reverse Current (Per Diode)**

**Figure 6. MBRF20100CT Typical Forward Voltage (Per Diode)**

**Figure 7. MBRF20150CT Typical Forward Voltage (Per Diode)**
**Figure 8. MBRF20200CT Typical Forward Voltage (Per Diode)**

**TO220FP SG PACKAGE OUTLINE**

DIM	MILLIMETERS		INCHES	
	MIN	MAX	MIN	MAX
A1	2.7	3.3	0.106	0.130
A2	15.0	15.7	0.591	0.618
A4	6.2	6.6	0.244	0.260
b	0.5	0.9	0.020	0.035
b1	0.9	1.2	0.035	0.047
b2	1.0	1.2	0.039	0.047
c	0.4	0.6	0.016	0.024
D	9.8	10.3	0.386	0.406
e	2.34	2.74	0.092	0.108
E	4.3	4.6	0.169	0.181
E1	2.5	2.9	0.098	0.114
F	2.6	3.0	0.102	0.118
L	10.3	10.7	0.406	0.421
ØP	3.0	3.4	0.118	0.134
Q	2.3	2.7	0.091	0.106

## **NOTICE**

The information presented in this document is for reference only. Tak Cheong reserves the right to make changes without notice for the specification of the products displayed herein.

The product listed herein is designed to be used with ordinary electronic equipment or devices, and not designed to be used with equipment or devices which require high level of reliability and the malfunction of which would directly endanger human life (such as medical instruments, transportation equipment, aerospace machinery, nuclear-reactor controllers, fuel controllers and other safety devices), Tak Cheong Semiconductor Co., Ltd., or anyone on its behalf, assumes no responsibility or liability for any damages resulting from such improper use of sale.

This publication supersedes & replaces all information previously supplied. For additional information, please visit our website <http://www.takcheong.com>, or consult your nearest Tak Cheong's sales office for further assistance.