

The Linear IC's Three-Terminal Low Current Positive Voltage Regulators

DESCRIPTION

The 78L00A Series of three terminal positive voltage regulators is available with several fixed output voltages making them useful in a wide range of applications. These regulators are inexpensive, vise-to-use devices suitable for a multitude of applications that require a regulated supply of up to 100 mA. These regulators feature internal current limiting and thermal shutdown making them remarkably rugged. No external components are required with the 78L00A devices in many applications.

These devices offer a substantial performance advantage over the traditional zener diode-resistor combination, as output impedance and quiescent current are substantially reduced.

The voltages available allow the 78L00A to be used in logic systems, instrumentation, HiFi, and other solid state electronic equipment.

The 78L00A is available in 3-Pin plastic package SOT54 (Z), 3-Pin mini power plastic package SOT89 (F) and the 8-Pin plastic package SO8 (D) offers superior quality and performance at low cost.

FEATURES

- High Output Current
 $I_o = 100 \text{ mA}$
- Fixed Output Voltage
 $V_o = 5 \text{ V}, 6 \text{ V}, 8 \text{ V}, 12 \text{ V}, 15 \text{ V}$
- Complementary Negative Regulators 79L00A Series
- Available in either $\pm 5\%$ (AC) Selection

DEVICE TYPE / NOMINAL VOLTAGE

5% Output Voltage Accuracy	Voltage	Package		
		Z Suffix	F Suffix	D Suffix
78L05AC	5	78L05ACZ	78L05ACF	78L05ACD
78L06AC	6	78L06ACZ	78L06ACF	78L06ACD
78L08AC	8	78L08ACZ	78L08ACF	78L08ACD
78L09AC	9	78L09ACZ	78L09ACF	78L09ACD
78L12AC	12	78L12ACZ	78L12ACF	78L12ACD
78L15AC	15	78L15ACZ	78L15ACF	78L15ACD

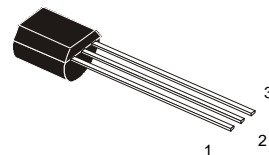

- 1 – Output
- 2 – Common
- 3 – Input

	SOT54
JEDEC	TO-92
EIAJ	SC-43
GOST	KT-26
Weight:	0.3g

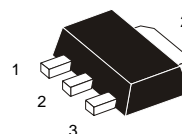

- 1 – Output
- 2 – Common
- 3 – Input

	SOT89
JEDEC	TO-243
EIAJ	SC-62
GOST	KT-47
Weight:	0.055g

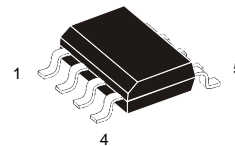

	SOT96-1
JEDEC	MS-012
EIAJ	–
GOST	4303.8-1
Weight:	0.08 ā

- 1 – Output, 2 – Common,
- 3 – Common, 4 – No Connect,
- 5 – No Connect, 6 – Common,
- 7 – Common, 8 – Input

78L00AC Series

ABSOLUTE MAXIMUM RATINGS ($T_A = 25\text{ }^\circ\text{C}$)

Rating	Symbol	Value	Unit
Input Voltage $V_o = 5\text{ V to }9\text{ V}$ $V_o = 12\text{ V to }15\text{ V}$	V_i	30 35	V
Output Current	I_o	100	mA
Maximum Power Dissipation Case KT-26 (TO-92) Z Suffix Case KT-47 (SOT-89) F Suffix Case 4303.8-1 (SO-8) D Suffix	P_D	500 350 500	mW
Junction Temperature	T_{JMAX}	150	$^\circ\text{C}$
Operating Junction Temperature Range	T_{OPR}	-40 to +70	$^\circ\text{C}$
Storage Temperature Range	T_{STG}	-40 to +150	$^\circ\text{C}$

ORDERING INFORMATION

Device	Marking	Package	Quantity	Packing Style
78LXXACZ*	78LXXACZ*	SOT-54	1 Kpcs / plastic bags / carton box	In bulk
78LXXACF*	8LXX*	SOT-89	5 Kpcs / plastic bags / carton box	In bulk
78LXXACF-T1*	8LXX*	SOT-89	1 Kpcs / Reel	Embossed tape 12-mm wide 7" dia. Pin 2 (Common) towards the windung. Perforation on the right.
78LXXACD*	78LXXACD*	SO-8	5 Kpcs / plastic bags / carton box	In bulk
78LXXACD-R1*	78LXXACD*	SO-8	500 pcs / Reel	Embossed tape 12-mm wide 7" dia. Pin 1 (Output) face to perforation side of the tape.
78LXXACD-R2*	78LXXACD*	SO-8	2.5 Kpcs / Reel	Embossed tape 12-mm wide 13" dia. Pin 1 (Output) face to perforation side of the tape.

Note 1:

XX indicates nominal voltage

*Available in 5, 6, 8, 9, 12 and 15 V devices.

78L00AC Series

78L05AC ELECTRICAL CHARACTERISTICS

($V_i = 10\text{ V}$, $I_o = 40\text{ mA}$, $C_i = 0.33\text{ }\mu\text{F}$, $C_o = 0.1\text{ }\mu\text{F}$, $T_A = 25\text{ }^\circ\text{C}$ unless otherwise noted)

Characteristic	Symbol	Min	Typ	Max	Unit
Output Voltage	V_o	4.8	5.0	5.2	V
Output Voltage, $7.0\text{V} < V_i < 20.0\text{V}$, $1\text{mA} < I_o < 40\text{mA}$	V_o	4.75	–	5.25	V
Line Regulation, $7.0\text{V} < V_i < 20.0\text{V}$		–	–	150	mV
Load Regulation, $1\text{mA} < I_o < 100\text{mA}$ $1\text{mA} < I_o < 40\text{mA}$		– –	– –	60 30	mV
Input Bias Current	I_{IB}	–	–	6	mA
Input Bias Current, $8.0\text{V} < V_i < 20.0\text{V}$, $1\text{mA} < I_o < 40\text{mA}$	ΔI_{IB}	–	–	1.5	mA
Ripple Rejection, $8.0\text{V} < V_i < 18.0\text{V}$, $I_o=40\text{mA}$, $f=120\text{Hz}$	RR	41	–	–	dB
Dropout Voltage	$V_i - V_o$		1.7	–	V

78L06AC ELECTRICAL CHARACTERISTICS

($V_i = 12\text{ V}$, $I_o = 40\text{ mA}$, $C_i = 0.33\text{ }\mu\text{F}$, $C_o = 0.1\text{ }\mu\text{F}$, $T_A = 25\text{ }^\circ\text{C}$ unless otherwise noted)

Characteristic	Symbol	Min	Typ	Max	Unit
Output Voltage	V_o	5.75	6.0	6.25	V
Output Voltage, $8.5\text{V} < V_i < 20.0\text{V}$, $1\text{mA} < I_o < 40\text{mA}$	V_o	5.7	–	6.3	V
Line Regulation, $8.5\text{V} < V_i < 20.0\text{V}$		–	–	175	mV
Load Regulation, $1\text{mA} < I_o < 100\text{mA}$ $1\text{mA} < I_o < 40\text{mA}$		– –	– –	80 40	mV
Input Bias Current	I_{IB}	–	–	6	mA
Input Bias Current, $9.0\text{V} < V_i < 20.0\text{V}$, $1\text{mA} < I_o < 40\text{mA}$	ΔI_{IB}	–	–	1.5	mA
Ripple Rejection, $10.0\text{V} < V_i < 20.0\text{V}$, $I_o=40\text{mA}$, $f=120\text{Hz}$	RR	40	–	–	dB
Dropout Voltage	$V_i - V_o$		1.7	–	V

78L00AC Series

78L08AC ELECTRICAL CHARACTERISTICS

($V_i = 14\text{ V}$, $I_o = 40\text{ mA}$, $C_i = 0.33\text{ }\mu\text{F}$, $C_o = 0.1\text{ }\mu\text{F}$, $T_A = 25\text{ }^\circ\text{C}$ unless otherwise noted)

Characteristic	Symbol	Min	Typ	Max	Unit
Output Voltage	V_o	7.7	8.0	8.3	V
Output Voltage, $10.5\text{V} < V_i < 23.0\text{V}$, $1\text{mA} < I_o < 40\text{mA}$	V_o	7.6	–	8.4	V
Line Regulation, $10.5\text{V} < V_i < 23.0\text{V}$		–	–	175	mV
Load Regulation, $1\text{mA} < I_o < 100\text{mA}$ $1\text{mA} < I_o < 40\text{mA}$		–	–	80 40	mV
Input Bias Current	I_{IB}	–	–	6	mA
Input Bias Current, $11.0\text{V} < V_i < 23.0\text{V}$, $1\text{mA} < I_o < 40\text{mA}$	ΔI_{IB}	–	–	1.5	mA
Ripple Rejection, $13.0\text{V} < V_i < 23.0\text{V}$, $I_o=40\text{mA}$, $f=120\text{Hz}$	RR	37	–	–	dB
Dropout Voltage	$V_i - V_o$		1.7	–	V

78L09AC ELECTRICAL CHARACTERISTICS

($V_i = 16\text{ V}$, $I_o = 40\text{ mA}$, $C_i = 0.33\text{ }\mu\text{F}$, $C_o = 0.1\text{ }\mu\text{F}$, $T_A = 25\text{ }^\circ\text{C}$ unless otherwise noted)

Characteristic	Symbol	Min	Typ	Max	Unit
Output Voltage	V_o	8.6	9.0	9.4	V
Output Voltage, $12.0\text{V} < V_i < 24.0\text{V}$, $1\text{mA} < I_o < 40\text{mA}$	V_o	8.55	–	9.45	V
Line Regulation, $12.0\text{V} < V_i < 24.0\text{V}$		–	–	175	mV
Load Regulation, $1\text{mA} < I_o < 100\text{mA}$ $1\text{mA} < I_o < 40\text{mA}$		–	–	90 40	mV
Input Bias Current	I_{IB}	–	–	6	mA
Input Bias Current, $13.0\text{V} < V_i < 24.0\text{V}$, $1\text{mA} < I_o < 40\text{mA}$	ΔI_{IB}	–	–	1.5	mA
Ripple Rejection, $15.0\text{V} < V_i < 25.0\text{V}$, $I_o=40\text{mA}$, $f=120\text{Hz}$	RR	37	–	–	dB
Dropout Voltage	$V_i - V_o$		1.7	–	V

78L00AC Series

78L12AC ELECTRICAL CHARACTERISTICS

($V_i = 19\text{ V}$, $I_o = 40\text{ mA}$, $C_i = 0.33\text{ }\mu\text{F}$, $C_o = 0.1\text{ }\mu\text{F}$, $T_A = 25\text{ }^\circ\text{C}$ unless otherwise noted)

Characteristic	Symbol	Min	Typ	Max	Unit
Output Voltage	V_o	11.5	12.0	12.5	V
Output Voltage, $14.0\text{V} < V_i < 27.0\text{V}$, $1\text{mA} < I_o < 40\text{mA}$	V_o	11.4	–	12.6	V
Line Regulation, $14.5\text{V} < V_i < 27.0\text{V}$		–	–	250	mV
Load Regulation, $1\text{mA} < I_o < 100\text{mA}$ $1\text{mA} < I_o < 40\text{mA}$		–	–	100 50	mV
Input Bias Current	I_{IB}	–	–	6.5	mA
Input Bias Current, $16.0\text{V} < V_i < 27.0\text{V}$, $1\text{mA} < I_o < 40\text{mA}$	ΔI_{IB}	–	–	1.5	mA
Ripple Rejection, $15.0\text{V} < V_i < 25.0\text{V}$, $I_o=40\text{mA}$, $f=120\text{Hz}$	RR	37	–	–	dB
Dropout Voltage	$V_i - V_o$		1.7	–	V

78L15AC ELECTRICAL CHARACTERISTICS

($V_i = 23\text{ V}$, $I_o = 40\text{ mA}$, $C_i = 0.33\text{ }\mu\text{F}$, $C_o = 0.1\text{ }\mu\text{F}$, $T_A = 25\text{ }^\circ\text{C}$ unless otherwise noted)

Characteristic	Symbol	Min	Typ	Max	Unit
Output Voltage	V_o	14.4	15.0	15.6	V
Output Voltage, $17.5\text{V} < V_i < 30.0\text{V}$, $1\text{mA} < I_o < 40\text{mA}$	V_o	14.25	–	15.75	V
Line Regulation, $17.5\text{V} < V_i < 30.0\text{V}$		–	–	300	mV
Load Regulation, $1\text{mA} < I_o < 100\text{mA}$ $1\text{mA} < I_o < 40\text{mA}$		–	–	150 75	mV
Input Bias Current	I_{IB}	–	–	6.5	mA
Input Bias Current, $19.0\text{V} < V_i < 30.0\text{V}$, $1\text{mA} < I_o < 40\text{mA}$	ΔI_{IB}	–	–	1.5	mA
Ripple Rejection, $18.5\text{V} < V_i < 28.5\text{V}$, $I_o=40\text{mA}$, $f=120\text{Hz}$	RR	34	–	–	dB
Dropout Voltage	$V_i - V_o$		1.7	–	V

78L00AC Series

PACKAGE DIMENSIONS of 78L00ACZ in mm

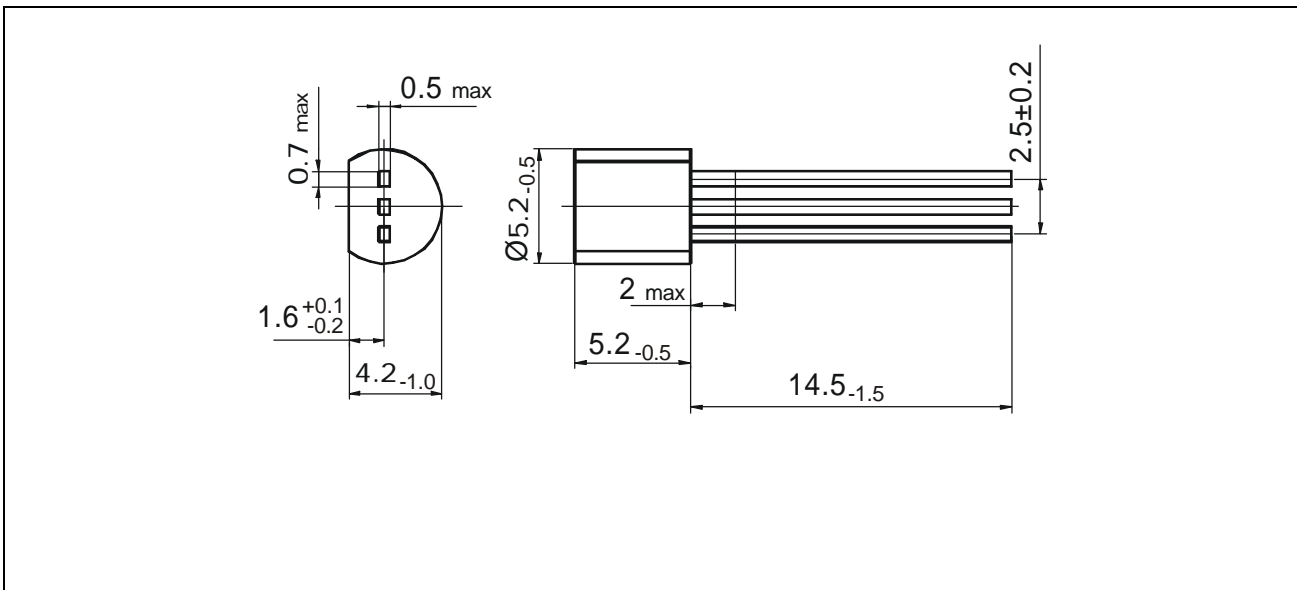

PLASTIC CASE KT-26

PACKAGE DIMENSIONS of 78L00ACF in mm

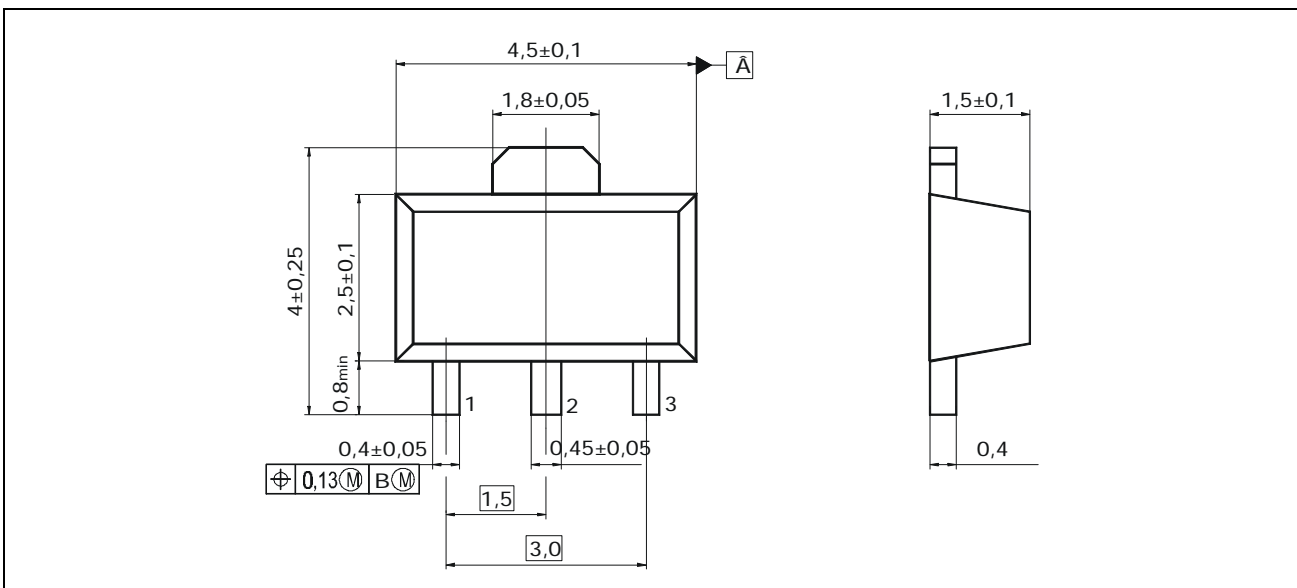

PLASTIC CASE KT-47

PACKAGE DIMENSIONS of 78L00ACD in mm

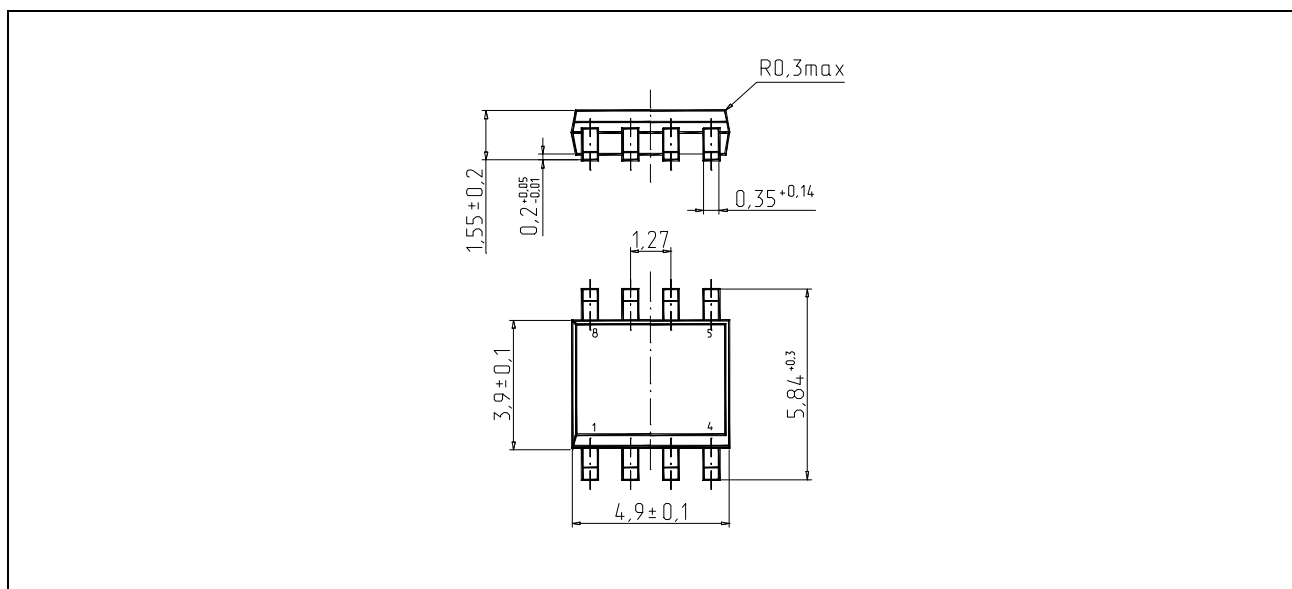

PLASTIC CASE 4303-8.1