



DC COMPONENTS CO., LTD.

RECTIFIER SPECIALISTS

KBPC / MB
15005 / 1505

THRU

KBPC / MB
1510 / 1510

TECHNICAL SPECIFICATIONS OF SINGLE-PHASE SILICON BRIDGE RECTIFIER
VOLTAGE RANGE - 50 to 1000 Volts **CURRENT - 15 Amperes**

FEATURES

- * Metal case for Maximum Heat Dissipation
- * Surge overload ratings-300 Amperes
- * Low forward voltage drop

MECHANICAL DATA

- * Case: Metal case, electrically isolated
- * Epoxy: UL 94V-0 rate flame retardant
- * Terminals: Plated .25"(6.35mm) Faston lugs, Solderable per MIL-STD-202E, Method 208 guaranteed
- * Polarity: As marked
- * Mounting position: Any
- * Weight: 30 grams

MAXIMUM RATINGS AND ELECTRICAL CHARACTERISTICS

Ratings at 25 °C ambient temperature unless otherwise specified.
 Single phase, half wave, 60 Hz, resistive or inductive load.
 For capacitive load, derate current by 20%.



MB-25

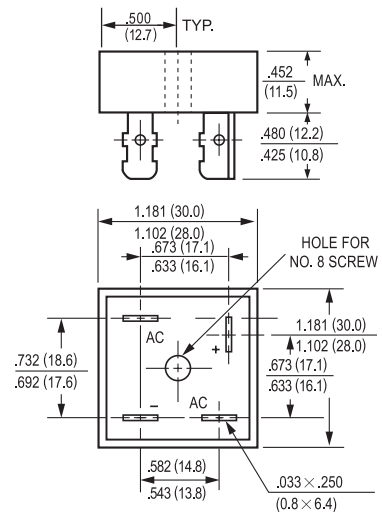

Dimensions in inches and (millimeters)

	SYMBOL	KBPC 15005	KBPC 1501	KBPC 1502	KBPC 1504	KBPC 1506	KBPC 1508	KBPC 1510	UNITS
Maximum Recurrent Peak Reverse Voltage	V _{RRM}	50	100	200	400	600	800	1000	Volts
Maximum RMS Bridge Input Voltage	V _{RMS}	35	70	140	280	420	560	700	Volts
Maximum DC Blocking Voltage	V _{DC}	50	100	200	400	600	800	1000	Volts
Maximum Average Forward Rectified Output Current at T _c = 55 °C	I _O	15.0							Amps
Peak Forward Surge Current 8.3 ms single half sine-wave superimposed on rated load (JEDEC method)	I _{FSM}	300							Amps
Maximum Forward Voltage Drop per element at 7.5A DC	V _F	1.1							Volts
Maximum DC Reverse Current at Rated DC Blocking Voltage per element	I _R	@T _A = 25 °C							uAmps
		@T _C = 100 °C							
I ² t Rating for Fusing (t<8.3ms)	I ² t	374							A ² Sec
Typical Junction Capacitance (Note1)	C _J	40							pF
Typical Thermal Resistance (Note 2)	R _{θJA}	19							°C/W
Operating and Storage Temperature Range	T _J ,T _{STG}	-55 to + 175							°C

NOTES : 1.Measured at 1 MHz and applied reverse voltage of 4.0 volts

2. Thermal Resistance from Junction to Ambient and from junction to lead mounted on P.C.B. with 0.47 x 0.47" (12x12mm) copper pads.

RATING AND CHARACTERISTIC CURVES (KBPC15005 MB1505 THRU KBPC1510 MB1510)

FIG. 1 - MAXIMUM NON-REPETITIVE FORWARD SURGE CURRENT

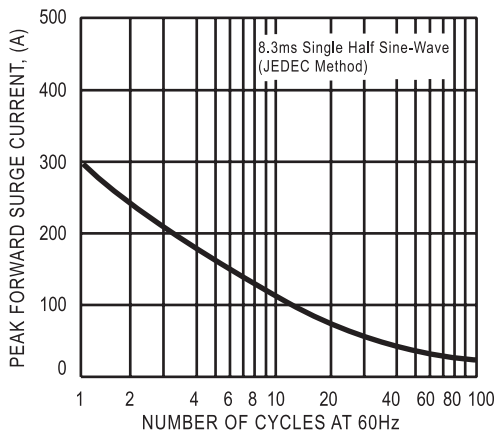

FIG. 2 - TYPICAL FORWARD CURRENT DERATING CURVE

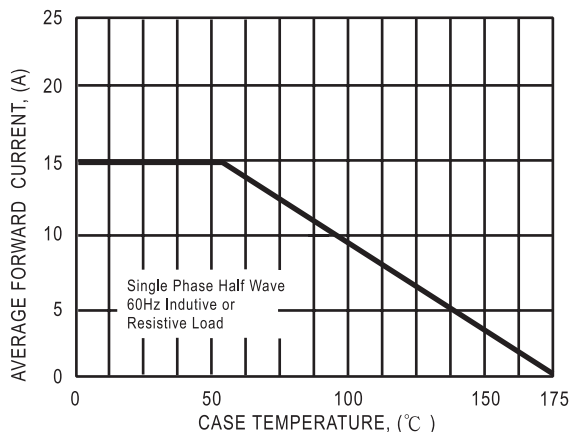

FIG. 3 - TYPICAL INSTANTANEOUS FORWARD CHARACTERISTICS

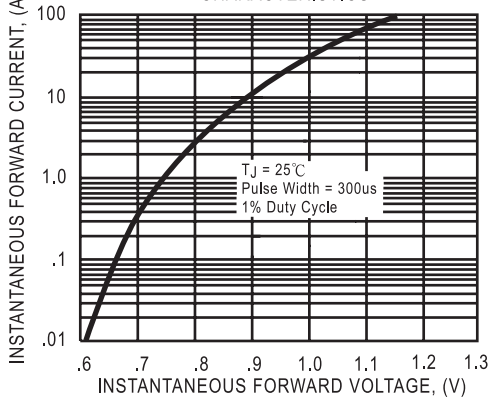
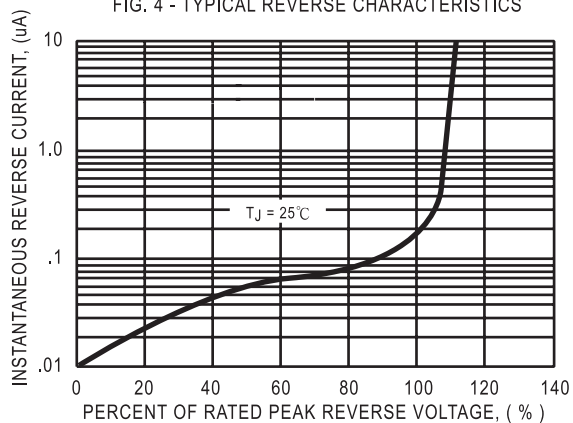

FIG. 4 - TYPICAL REVERSE CHARACTERISTICS





DC COMPONENTS CO., LTD.

RECTIFIER SPECIALISTS

KBPC / MB
15005W / 1505W
THRU
KBPC / MB
1510W / 1510W

TECHNICAL SPECIFICATIONS OF SINGLE-PHASE SILICON BRIDGE RECTIFIER

VOLTAGE RANGE - 50 to 1000 Volts

CURRENT - 15 Amperes

FEATURES

- * Metal case for Maximum Heat Dissipation
- * Surge overload ratings-300 Amperes
- * Low forward voltage drop

MECHANICAL DATA

- * Case: Metal, electrically isolated
- * Epoxy: UL 94V-0 rate flame retardant
- * Lead: MIL-STD-202E, Method 208 guaranteed
- * Polarity: As marked
- * Mounting position: Any
- * Weight: 30 grams

MAXIMUM RATINGS AND ELECTRICAL CHARACTERISTICS

Ratings at 25 °C ambient temperature unless otherwise specified.
Single phase, half wave, 60 Hz, resistive or inductive load.
For capacitive load, derate current by 20%.



MB-25W

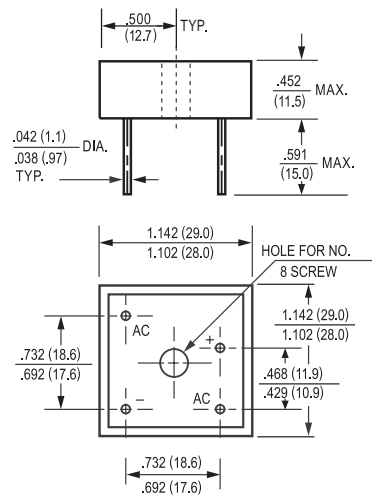

KBPC 15005W	KBPC 1501W	KBPC 1502W	KBPC 1504W	KBPC 1506W	KBPC 1508W	KBPC 1510W
----------------	---------------	---------------	---------------	---------------	---------------	---------------

	SYMBOL	MB1505W	MB151W	MB152W	MB154W	MB156W	MB158W	MB1510W	UNITS
Maximum Recurrent Peak Reverse Voltage	V _{RRM}	50	100	200	400	600	800	1000	Volts
Maximum RMS Bridge Input Voltage	V _{RMS}	35	70	140	280	420	560	700	Volts
Maximum DC Blocking Voltage	V _{DC}	50	100	200	400	600	800	1000	Volts
Maximum Average Forward Rectified Output Current at T _c = 55°C	I _o	15							Amps
Peak Forward Surge Current 8.3 ms single half sine-wave superimposed on rated load (JEDEC Method)	I _{FSM}	300							Amps
Maximum Forward Voltage Drop per element at 7.5A DC	V _F	1.1							Volts
Maximum DC Reverse Current at Rated	I _R	10							uAmps
DC Blocking Voltage per element		500							
I ² t Rating for Fusing (t<8.3ms)	I ² t	374							A ² Sec
Typical Junction Capacitance (Note1)	C _J	300							pF
Typical Thermal Resistance (Note 2)	R _{θJC}	2.5							°C/W
Operating and Storage Temperature Range	T _J , T _{STG}	-55 to + 150							°C

NOTES : 1. Measured at 1 MHz and applied reverse voltage of 4.0 volts
2. Thermal Resistance from Junction to Case per leg.

RATING AND CHARACTERISTIC CURVES (KBPC15005W MB1505W THRU KBPC1510W MB1510W)

FIG. 1 - MAXIMUM NON-REPETITIVE FORWARD SURGE CURRENT

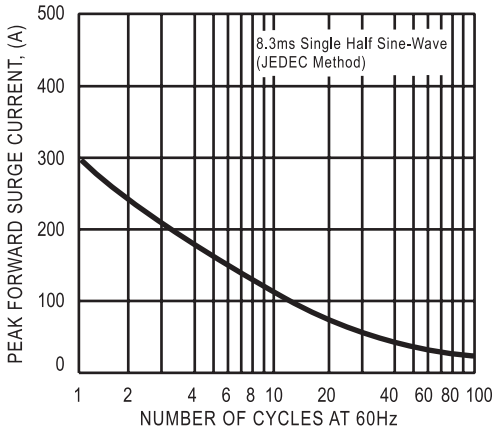

FIG. 2 - TYPICAL FORWARD CURRENT DERATING CURVE

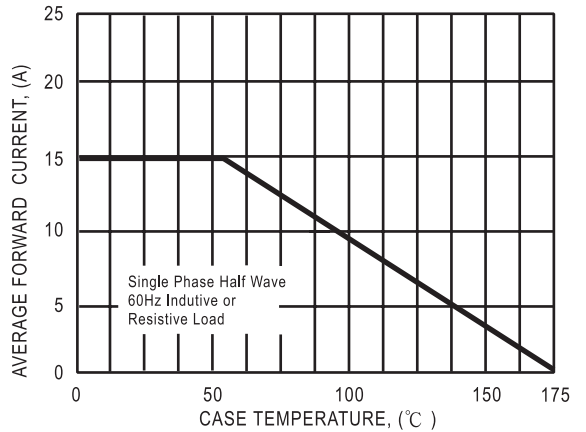

FIG. 3 - TYPICAL INSTANTANEOUS FORWARD CHARACTERISTICS

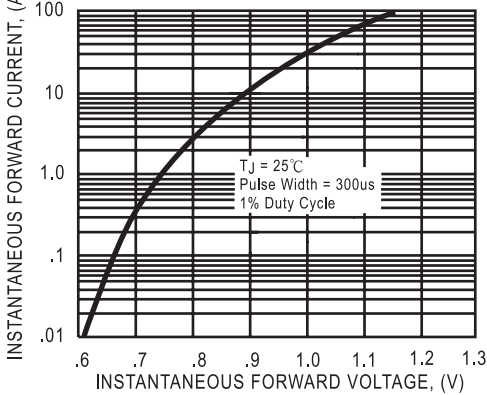

FIG. 4 - TYPICAL REVERSE CHARACTERISTICS

