

## SUBMINIATURE, HIGH SENSITIVITY PHOTOINTERRUPTER

### \*Features

- Compact and thin.
- Visible light cut-off type.
- High sensitivity.
- Package: 1000pcs/Reel.
- Moisture sensitivity level : level 4.
- RoHS Compliant.

### \*Applications

- Cassette tape recorders, VCRs.
- Floppy disk drives.
- Various microcomputerized control equipment.

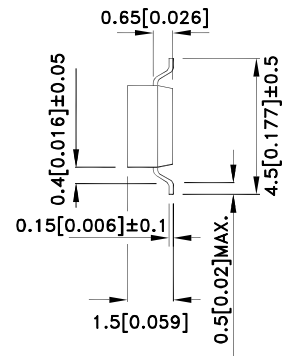
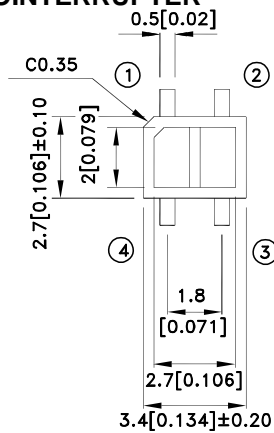

- ① Anode                      ② Emitter  
 ③ Collector                ④ Cathode

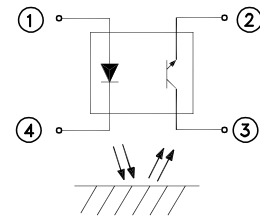

UNIT : MM[INCH]  
 TOLERANCE :±0.25[± 0.01] UNLESS OTHERWISE NOTED.

### \*Absolute Maximum Ratings

Parameter		Symbol	Rating	Unit
Input	Forward current	$I_F$	50	mA
	Reverse voltage	$V_R$	6	V
	Power dissipation	$P_D$	75	mW
	Peak Forward Current (Pulse Width $\leq 100\mu\text{s}$ , Duty Cycle =1%)	$I_{FP}$	1	A
Output	Collector-emitter voltage	$V_{CEO}$	35	V
	Emitter-collector voltage	$V_{ECO}$	6	V
	Collector current	$I_C$	20	mA
	Collector power dissipation	$P_C$	75	mW
Operating temperature		$T_{opr}$	-25~+85	°C
Storage temperature		$T_{stg}$	-40~+100	°C
soldering temperature (1/16 inch from body for 5 seconds)		$T_{sol}$	260	°C



## Electro-optical Characteristics

Parameter		Symbol	Conditions	Min.	TYP.	Max.	Unit	
Input	Forward Voltage	$V_F$	$I_F=20\text{mA}$	1.0	1.2	1.5	V	
	Reverse Current	$I_R$	$V_R=6\text{V}$	-	-	10	$\mu\text{A}$	
	Peak Wavelength	$\lambda_P$	$I_F=20\text{mA}$	-	940	-	nm	
Output	Collector Dark Current	$I_{CEO}$	$V_{CE}=20\text{V}$	-	$10^{-9}$	$10^{-7}$	A	
Transfer characteristics	*1 Collector Current	$I_C$	$V_{CE}=2\text{V}$ $I_F=4\text{mA}$	10	-	400	$\mu\text{A}$	
	*2 Leak Current	$I_{LEAK}$	$V_{CE}=2\text{V}$ $I_F=4\text{mA}$	-	-	0.1	$\mu\text{A}$	
	Response time	Rise time	$t_r$	$V_{CE}=2\text{V}$ $I_C=100\mu\text{A}$ $R_L=1\text{K}\Omega, d=1\text{mm}$	-	20	100	$\mu\text{sec}$
		Fall time	$t_f$		-	20	100	$\mu\text{sec}$

\*1 The condition and arrangement of the reflective object are shown below.  
 \*2 Without reflective object.

## Classification table of radiant flux

BIN CODE	E	F	G
$I_C$ ( $\mu\text{A}$ )	10~120	100~250	200~400

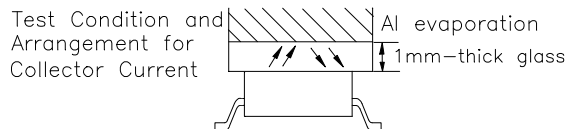

Fig. 1 Forward Current vs. Forward Voltage

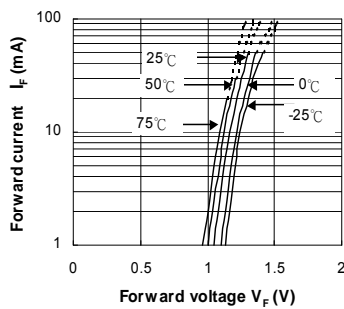

Fig. 2 Collector Current vs. Forward Current

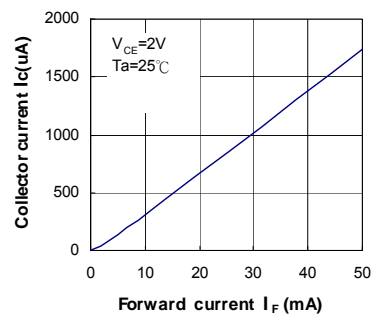

Fig. 3 Collector Current vs. Collector-emitter Voltage

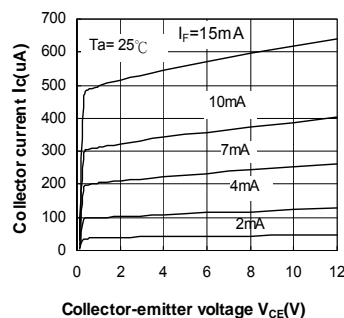

Fig. 4 Relative Collector Current vs. Ambient Temperature

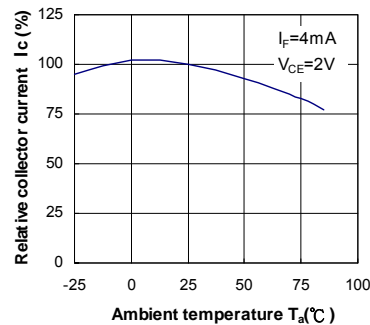
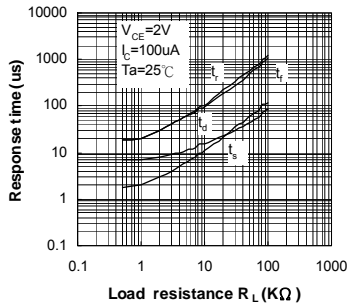

Fig. 5 Response Time vs. Load Resistance



Test Circuit for Response Time

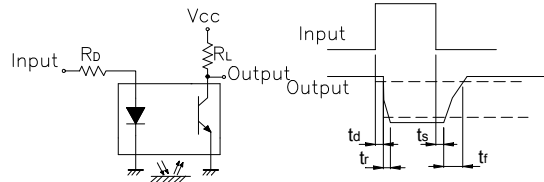

Fig. 6 Collector Dark Current vs. Ambient Temperature

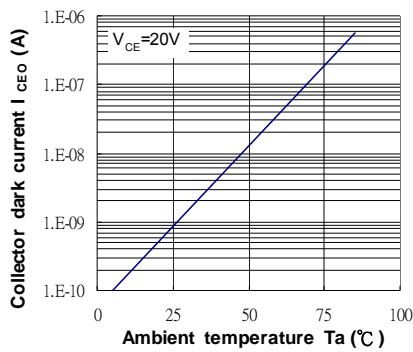

Fig. 7 Relative Collector Current vs. Distance between Sensor and Al Evaporation Glass

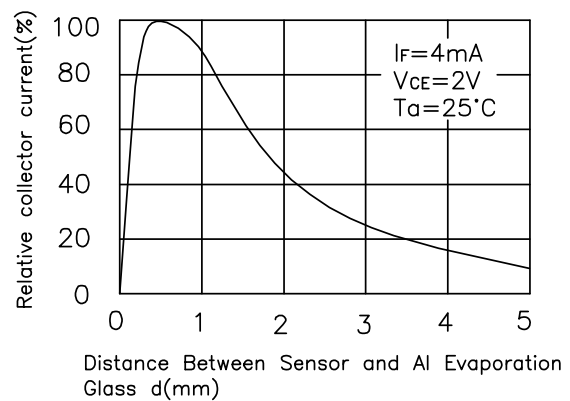

Fig. 8 Relative Collector Current vs. Card Moving Distance (1)

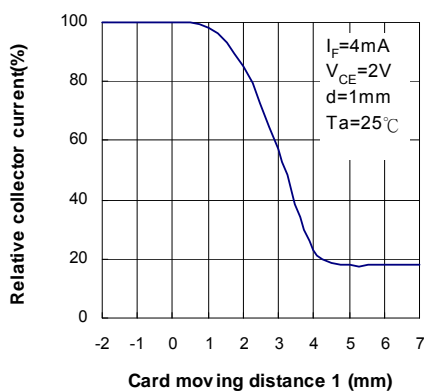
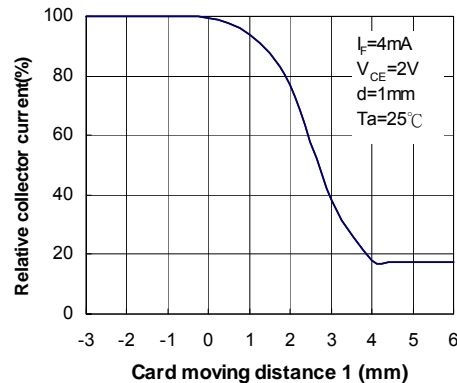

Fig. 9 Relative Collector Current vs. Card Moving Distance (2)



## Test Condition for Distance & Detecting Position Characteristics

Correspond to Fig. 7



Correspond to Fig. 8  
Test condition

$I_F = 4\text{mA}$   
 $V_{CE} = 2\text{V}$   
 $d = 1\text{mm}$

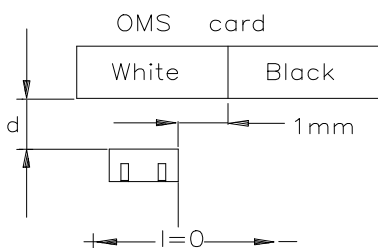

Correspond to Fig. 9  
Test condition

$I_F = 4\text{mA}$   
 $V_{CE} = 2\text{V}$   
 $d = 1\text{mm}$

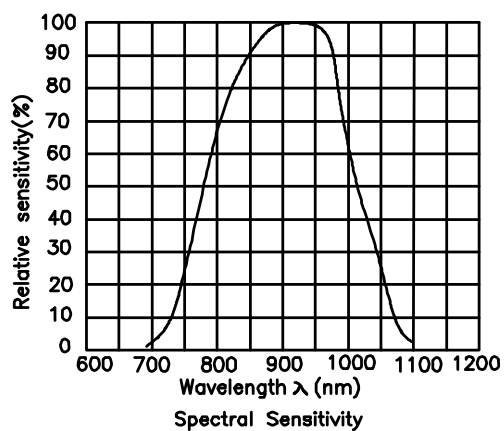
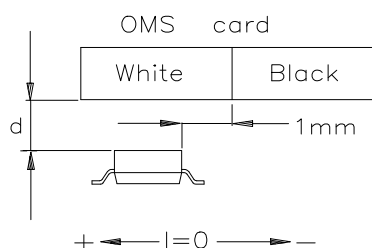

Reflow Soldering Profile For Lead-free SMT Process.

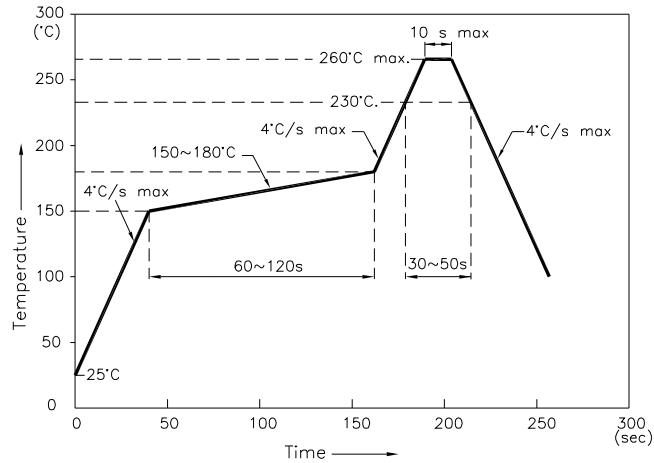

NOTES:

1. We recommend the reflow temperature 245°C(+/-5°C). The maximum soldering temperature should be limited to 260°C.
2. Don't cause stress to the epoxy resin while it is exposed to high temperature.
3. Number of reflow process shall be 2 times or less.

**Recommended Soldering Pattern  
(Units : mm; Tolerance: ±0.1)**

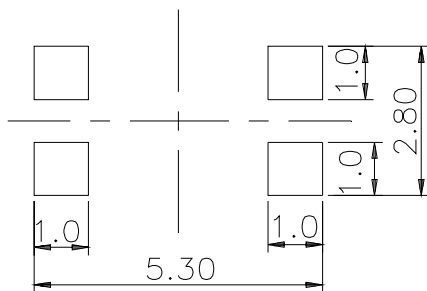

**Reel Dimension**

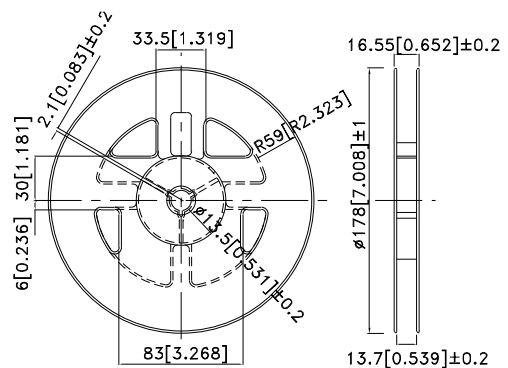

**Tape Specifications  
(Units : mm)**

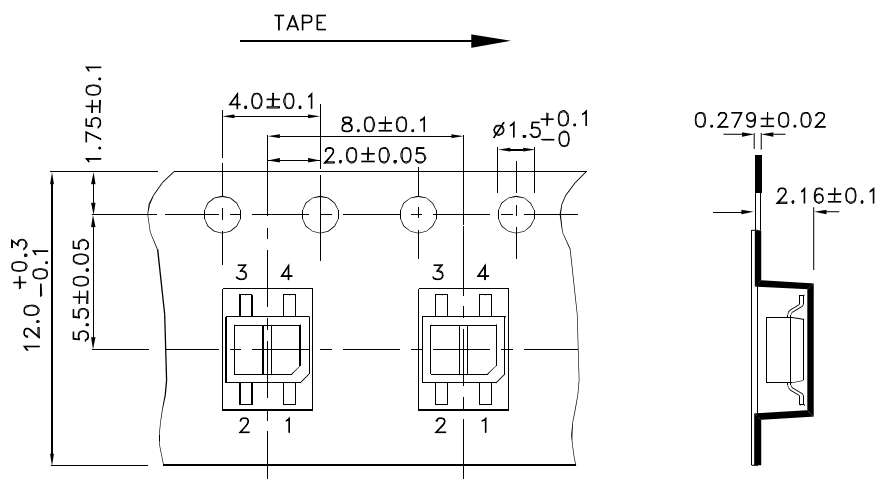

PACKING & LABEL SPECIFICATIONS

KTIR0711S

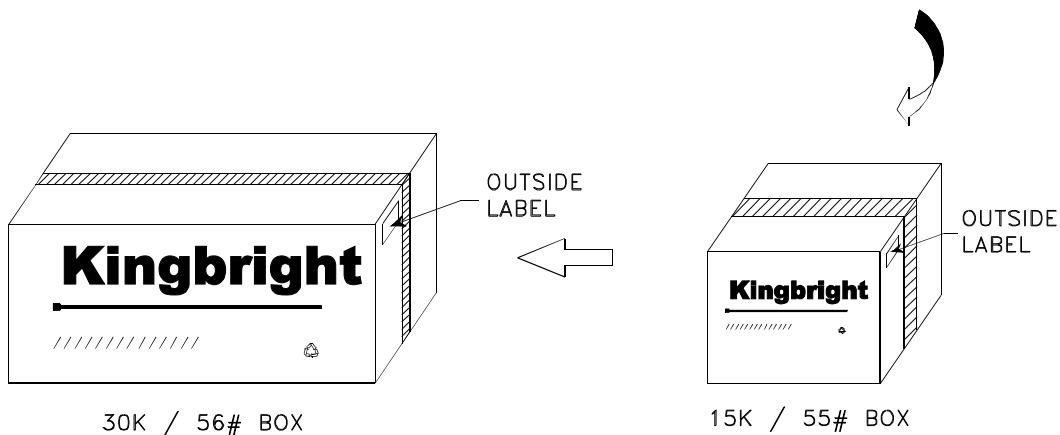
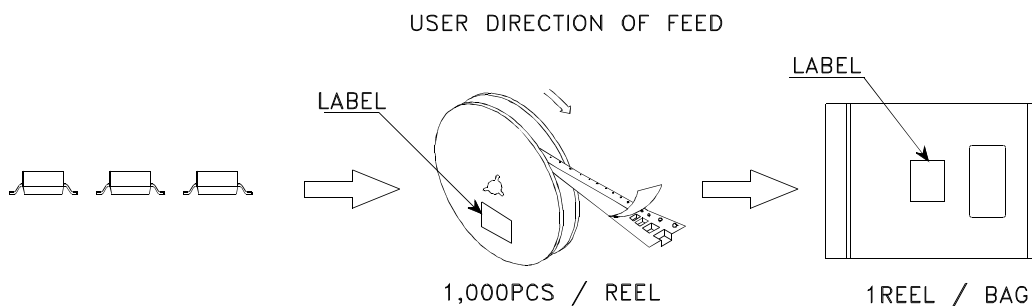

<h1>Kingbright</h1>				
P/NO: KTIRXXX				
QTY: 1,000 pcs	Q.C.			
S/N: XXXX	<table border="1"> <tr> <td>Q C</td> </tr> <tr> <td>xx xx xxxx</td> </tr> <tr> <td>PASSED</td> </tr> </table>	Q C	xx xx xxxx	PASSED
Q C				
xx xx xxxx				
PASSED				
CODE: XXX				
LOT NO:				
XXXXXXXXXXXXXXXXXX				
RoHS Compliant				

Detailed application notes are listed on our website.  
[http://www.kingbright.com/application\\_notes](http://www.kingbright.com/application_notes)