

NEGATIVE VOLTAGE REGULATORS

- OUTPUT CURRENT UP TO 1.5A
- OUTPUT VOLTAGES OF -5; -5.2; -6; -8; -12 ;
- 15; -18; -20; -22; -24V
- THERMAL OVERLOAD PROTECTION
- SHORT CIRCUIT PROTECTION
- OUTPUT TRANSISTOR SOA PROTECTION

DESCRIPTION

The L7900 series of three-terminal negative regulators is available in TO-220 and TO-3 packages and with several output voltages. They can provide local on-card regulation, eliminating the distribution problems associated with single point regulation; furthermore, having the same voltage options as the L7800 positive standard series, they are particularly suited for split power supplies. In addition, the -5.2V is also available for ECL system.

If adequate heatsinking is provided, the L7900 series can deliver an output current in excess of 1.5A. Although designed primarily as fixed voltage regulators, these devices can be used with external components to obtain adjustable voltages and currents.

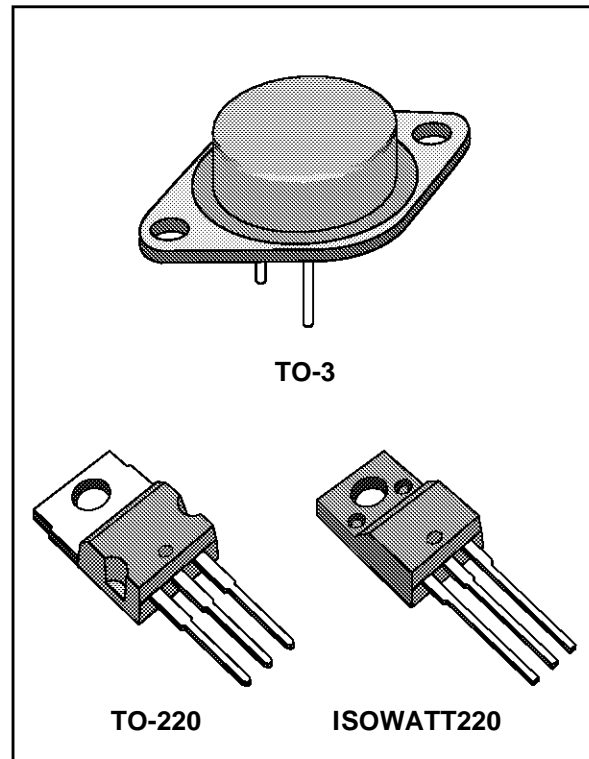

SCHEMATIC DIAGRAM

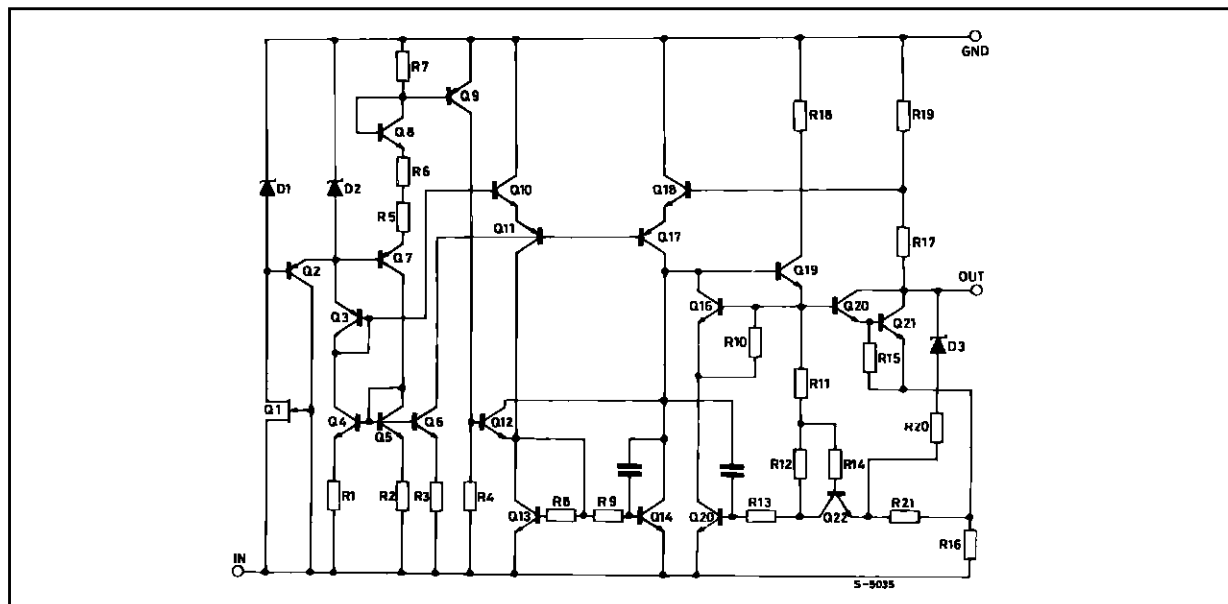

L7900 SERIES

ABSOLUTE MAXIMUM RATINGS

Symbol	Parameter	Value	Unit
V_i	DC Input Voltage (for $V_o = -5$ to $-18V$) (for $V_o = -20, -24V$)	- 35	V
		- 40	V
I_o	Output Current	Internally limited	
P_{tot}	Total Power Dissipation	Internally limited	
T_{op}	Operating Junction Temperature	0 to + 150	°C
T_{stg}	Storage Temperature	- 65 to + 150	°C

THERMAL DATA

			TO-3	TO-220	ISOWATT220	
$R_{thj-case}$	Thermal Resistance Junction-Case	Max	4	3	4	°C/W
$R_{thj-amb}$	Thermal Resistance Junction-Ambient	Max	35	50	60	°C/W

CONNECTION DIAGRAM AND ORDERING NUMBERS (top views)

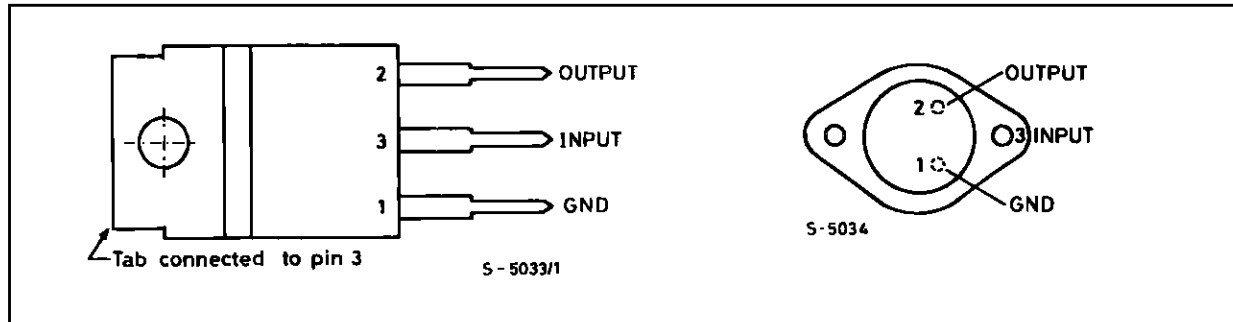

TYPE	TO-3	TO-220	ISOWATT220	OUTPUT VOLTAGE
L7905C	L7905CT	L7905CV	L7905CP	-5 V
L7952C	L7952CT	L7952CV		-5.2 V
L7906C	L7906CT	L7906CV	L7906CP	-6 V
L7908C	L7908CT	L7908CV	L7908CP	-8 V
L7912C	L7912CT	L7912CV	L7912CP	-12 V
L7915C	L7915CT	L7915CV	L7915CP	-15 V
L7918C	L7918CT	L7918CV	L7918CP	-18 V
L7920C	L7920CT	L7920CV	L7920CP	-20 V
L7922C	L7922CT	L7922CV		-22 V
L7924C	L7924CT	L7924CV	L7924CP	-24 V

APPLICATION CIRCUIT

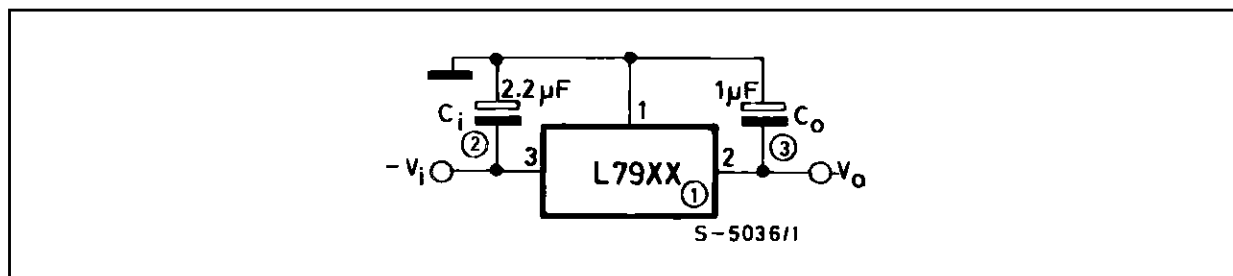

ELECTRICAL CHARACTERISTICS FOR L7905C (refer to the test circuits, $T_j = 0$ to 150 °C, $V_i = -10V$, $I_o = 500$ mA, $C_i = 2.2$ μF , $C_o = 1$ μF unless otherwise specified)

Symbol	Parameter	Test Conditions	Min.	Typ.	Max.	Unit
V_o	Output Voltage	$T_j = 25$ °C	-4.8	-5	-5.2	V
V_o	Output Voltage	$I_o = -5$ mA to -1 A $P_o \leq 15$ W $V_i = 8$ to 20 V	-4.75	-5	-5.25	V
ΔV_o^*	Line Regulation	$V_i = -7$ to -25 V $T_j = 25$ °C $V_i = -8$ to -12 V $T_j = 25$ °C			100 50	mV mV
ΔV_o^*	Load Regulation	$I_o = 5$ to 1500 mA $T_j = 25$ °C $I_o = 250$ to 750 mA $T_j = 25$ °C			100 50	mV mV
I_d	Quiescent Current	$T_j = 25$ °C			3	mA
ΔI_d	Quiescent Current Change	$I_o = 5$ to 1000 mA			0.5	mA
ΔI_d	Quiescent Current Change	$V_i = -8$ to -25 V			1.3	mA
$\frac{\Delta V_o}{\Delta T}$	Output Voltage Drift	$I_o = 5$ mA		-0.4		mV/°C
e_N	Output Noise Voltage	$B = 10$ Hz to 100 KHz $T_j = 25$ °C		100		μV
SVR	Supply Voltage Rejection	$\Delta V_i = 10$ V $f = 120$ Hz	54	60		dB
V_d	Dropout Voltage	$I_o = 1$ A $T_j = 25$ °C $\Delta V_o = 100$ mV		1.4		V
I_{sc}	Short Circuit Current			2.1		A
I_{scp}	Short Circuit Peak Current	$T_j = 25$ °C		2.5		A

ELECTRICAL CHARACTERISTICS FOR L7952C (refer to the test circuits, $T_j = 0$ to 150 °C, $V_i = -10V$, $I_o = 500$ mA, $C_i = 2.2$ μF , $C_o = 1$ μF unless otherwise specified)

Symbol	Parameter	Test Conditions	Min.	Typ.	Max.	Unit
V_o	Output Voltage	$T_j = 25$ °C	-5.0	-5.2	-5.4	V
V_o	Output Voltage	$I_o = -5$ mA to -1 A $P_o \leq 15$ W $V_i = -9$ to -21 V	-4.95	-5.2	-5.45	V
ΔV_o^*	Line Regulation	$V_i = -8$ to -25 V $T_j = 25$ °C $V_i = -9$ to -12 V $T_j = 25$ °C			105 52	mV mV
ΔV_o^*	Load Regulation	$I_o = 5$ to 1500 mA $T_j = 25$ °C $I_o = 250$ to 750 mA $T_j = 25$ °C			105 52	mV mV
I_d	Quiescent Current	$T_j = 25$ °C			3	mA
ΔI_d	Quiescent Current Change	$I_o = 5$ to 1000 mA			0.5	mA
ΔI_d	Quiescent Current Change	$V_i = -9$ to -25 V			1.3	mA
$\frac{\Delta V_o}{\Delta T}$	Output Voltage Drift	$I_o = 5$ mA		-0.5		mV/°C
e_N	Output Noise Voltage	$B = 10$ Hz to 100 KHz $T_j = 25$ °C		125		μV
SVR	Supply Voltage Rejection	$\Delta V_i = 10$ V $f = 120$ Hz	54	60		dB
V_d	Dropout Voltage	$I_o = 1$ A $T_j = 25$ °C $\Delta V_o = 100$ mV		1.4		V
I_{sc}	Short Circuit Current			2		A
I_{scp}	Short Circuit Peak Current	$T_j = 25$ °C		2.5		A

* Load and line regulation are specified at constant junction temperature. Changes in V_o due to heating effects must be taken into account separately. Pulse testing with low duty cycle is used.

L7900 SERIES

ELECTRICAL CHARACTERISTICS FOR L7906C (refer to the test circuits, $T_j = 0$ to 150 °C, $V_i = -11V$, $I_o = 500$ mA, $C_i = 2.2$ μF , $C_o = 1$ μF unless otherwise specified)

Symbol	Parameter	Test Conditions	Min.	Typ.	Max.	Unit
V_o	Output Voltage	$T_j = 25$ °C	-5.75	-6	-6.25	V
V_o	Output Voltage	$I_o = -5$ mA to -1 A $P_o \leq 15$ W $V_i = -9.5$ to -21.5 V	-5.7	-6	-6.3	V
ΔV_o^*	Line Regulation	$V_i = -8.5$ to -25 V $T_j = 25$ °C $V_i = -9$ to -15 V $T_j = 25$ °C			120 60	mV mV
ΔV_o^*	Load Regulation	$I_o = 5$ to 1500 mA $T_j = 25$ °C $I_o = 250$ to 750 mA $T_j = 25$ °C			120 60	mV mV
I_d	Quiescent Current	$T_j = 25$ °C			3	mA
ΔI_d	Quiescent Current Change	$I_o = 5$ to 1000 mA			0.5	mA
ΔI_d	Quiescent Current Change	$V_i = -9.5$ to -25 V			1.3	mA
$\frac{\Delta V_o}{\Delta T}$	Output Voltage Drift	$I_o = 5$ mA		-0.6		mV/°C
e_N	Output Noise Voltage	$B = 10$ Hz to 100 KHz $T_j = 25$ °C		144		μV
SVR	Supply Voltage Rejection	$\Delta V_i = 10$ V $f = 120$ Hz	54	60		dB
V_d	Dropout Voltage	$I_o = 1$ A $T_j = 25$ °C $\Delta V_o = 100$ mV		1.4		V
I_{sc}	Short Circuit Current			2		A
I_{scp}	Short Circuit Peak Current	$T_j = 25$ °C		2.5		A

ELECTRICAL CHARACTERISTICS FOR L7908C (refer to the test circuits, $T_j = 0$ to 150 °C, $V_i = -14V$, $I_o = 500$ mA, $C_i = 2.2$ μF , $C_o = 1$ μF unless otherwise specified)

Symbol	Parameter	Test Conditions	Min.	Typ.	Max.	Unit
V_o	Output Voltage	$T_j = 25$ °C	-7.7	-8	-8.3	V
V_o	Output Voltage	$I_o = -5$ mA to -1 A $P_o \leq 15$ W $V_i = -11.5$ to -23 V	-7.6	-8	-8.4	V
ΔV_o^*	Line Regulation	$V_i = -10.5$ to -25 V $T_j = 25$ °C $V_i = -11$ to -17 V $T_j = 25$ °C			160 80	mV mV
ΔV_o^*	Load Regulation	$I_o = 5$ to 1500 mA $T_j = 25$ °C $I_o = 250$ to 750 mA $T_j = 25$ °C			160 80	mV mV
I_d	Quiescent Current	$T_j = 25$ °C			3	mA
ΔI_d	Quiescent Current Change	$I_o = 5$ to 1000 mA			0.5	mA
ΔI_d	Quiescent Current Change	$V_i = -11.5$ to -25 V			1.3	mA
$\frac{\Delta V_o}{\Delta T}$	Output Voltage Drift	$I_o = 5$ mA		-0.6		mV/°C
e_N	Output Noise Voltage	$B = 10$ Hz to 100 KHz $T_j = 25$ °C		175		μV
SVR	Supply Voltage Rejection	$\Delta V_i = 10$ V $f = 120$ Hz	54	60		dB
V_d	Dropout Voltage	$I_o = 1$ A $T_j = 25$ °C $\Delta V_o = 100$ mV		1.1		V
I_{sc}	Short Circuit Current			1.5		A
I_{scp}	Short Circuit Peak Current	$T_j = 25$ °C		2.5		A

* Load and line regulation are specified at constant junction temperature. Changes in V_o due to heating effects must be taken into account separately. Pulse testing with low duty cycle is used.

ELECTRICAL CHARACTERISTICS FOR L7912C (refer to the test circuits, $T_j = 0$ to 150 °C, $V_i = -19V$, $I_o = 500$ mA, $C_i = 2.2$ μF , $C_o = 1$ μF unless otherwise specified)

Symbol	Parameter	Test Conditions	Min.	Typ.	Max.	Unit
V_o	Output Voltage	$T_j = 25$ °C	-11.5	-12	-12.5	V
V_o	Output Voltage	$I_o = -5$ mA to -1 A $P_o \leq 15$ W $V_i = -15.5$ to -27 V	-11.4	-12	-12.6	V
ΔV_o^*	Line Regulation	$V_i = -14.5$ to -30 V $T_j = 25$ °C $V_i = -16$ to -22 V $T_j = 25$ °C			240 120	mV mV
ΔV_o^*	Load Regulation	$I_o = 5$ to 1500 mA $T_j = 25$ °C $I_o = 250$ to 750 mA $T_j = 25$ °C			240 120	mV mV
I_d	Quiescent Current	$T_j = 25$ °C			3	mA
ΔI_d	Quiescent Current Change	$I_o = 5$ to 1000 mA			0.5	mA
ΔI_d	Quiescent Current Change	$V_i = -15$ to -30 V			1	mA
$\frac{\Delta V_o}{\Delta T}$	Output Voltage Drift	$I_o = 5$ mA		-0.8		mV/°C
e_N	Output Noise Voltage	$B = 10$ Hz to 100 KHz $T_j = 25$ °C		200		μV
SVR	Supply Voltage Rejection	$\Delta V_i = 10$ V $f = 120$ Hz	54	60		dB
V_d	Dropout Voltage	$I_o = 1$ A $T_j = 25$ °C $\Delta V_o = 100$ mV		1.1		V
I_{sc}	Short Circuit Current			1.5		A
I_{scp}	Short Circuit Peak Current	$T_j = 25$ °C		2.5		A

ELECTRICAL CHARACTERISTICS FOR L7915C (refer to the test circuits, $T_j = 0$ to 150 °C, $V_i = -23V$, $I_o = 500$ mA, $C_i = 2.2$ μF , $C_o = 1$ μF unless otherwise specified)

Symbol	Parameter	Test Conditions	Min.	Typ.	Max.	Unit
V_o	Output Voltage	$T_j = 25$ °C	-14.4	-15	-15.6	V
V_o	Output Voltage	$I_o = -5$ mA to -1 A $P_o \leq 15$ W $V_i = -18.5$ to -30 V	-14.3	-15	-15.7	V
ΔV_o^*	Line Regulation	$V_i = -17.5$ to -30 V $T_j = 25$ °C $V_i = -20$ to -26 V $T_j = 25$ °C			300 150	mV mV
ΔV_o^*	Load Regulation	$I_o = 5$ to 1500 mA $T_j = 25$ °C $I_o = 250$ to 750 mA $T_j = 25$ °C			300 150	mV mV
I_d	Quiescent Current	$T_j = 25$ °C			3	mA
ΔI_d	Quiescent Current Change	$I_o = 5$ to 1000 mA			0.5	mA
ΔI_d	Quiescent Current Change	$V_i = -18.5$ to -30 V			1	mA
$\frac{\Delta V_o}{\Delta T}$	Output Voltage Drift	$I_o = 5$ mA		-0.9		mV/°C
e_N	Output Noise Voltage	$B = 10$ Hz to 100 KHz $T_j = 25$ °C		250		μV
SVR	Supply Voltage Rejection	$\Delta V_i = 10$ V $f = 120$ Hz	54	60		dB
V_d	Dropout Voltage	$I_o = 1$ A $T_j = 25$ °C $\Delta V_o = 100$ mV		1.1		V
I_{sc}	Short Circuit Current			1.3		A
I_{scp}	Short Circuit Peak Current	$T_j = 25$ °C		2.3		A

* Load and line regulation are specified at constant junction temperature. Changes in V_o due to heating effects must be taken into account separately. Pulse testing with low duty cycle is used.

L7900 SERIES

ELECTRICAL CHARACTERISTICS FOR L7918C (refer to the test circuits, $T_j = 0$ to 150 °C, $V_i = -27V$, $I_o = 500$ mA, $C_i = 2.2$ μF , $C_o = 1$ μF unless otherwise specified)

Symbol	Parameter	Test Conditions	Min.	Typ.	Max.	Unit
V_o	Output Voltage	$T_j = 25$ °C	-17.3	-18	-18.7	V
V_o	Output Voltage	$I_o = -5$ mA to -1 A $P_o \leq 15$ W $V_i = -22$ to -33 V	-17.1	-18	-18.9	V
ΔV_o^*	Line Regulation	$V_i = -21$ to -33 V $T_j = 25$ °C $V_i = -24$ to -30 V $T_j = 25$ °C			360 180	mV mV
ΔV_o^*	Load Regulation	$I_o = 5$ to 1500 mA $T_j = 25$ °C $I_o = 250$ to 750 mA $T_j = 25$ °C			360 180	mV mV
I_d	Quiescent Current	$T_j = 25$ °C			3	mA
ΔI_d	Quiescent Current Change	$I_o = 5$ to 1000 mA			0.5	mA
ΔI_d	Quiescent Current Change	$V_i = -22$ to -33 V			1	mA
$\frac{\Delta V_o}{\Delta T}$	Output Voltage Drift	$I_o = 5$ mA		-1		mV/°C
e_N	Output Noise Voltage	$B = 10$ Hz to 100 KHz $T_j = 25$ °C		300		μV
SVR	Supply Voltage Rejection	$\Delta V_i = 10$ V $f = 120$ Hz	54	60		dB
V_d	Dropout Voltage	$I_o = 1$ A $T_j = 25$ °C $\Delta V_o = 100$ mV		1.1		V
I_{sc}	Short Circuit Current			1.1		A
I_{scp}	Short Circuit Peak Current	$T_j = 25$ °C		2.2		A

ELECTRICAL CHARACTERISTICS FOR L7920C (refer to the test circuits, $T_j = 0$ to 150 °C, $V_i = -29V$, $I_o = 500$ mA, $C_i = 2.2$ μF , $C_o = 1$ μF unless otherwise specified)

Symbol	Parameter	Test Conditions	Min.	Typ.	Max.	Unit
V_o	Output Voltage	$T_j = 25$ °C	-19.2	-20	-20.8	V
V_o	Output Voltage	$I_o = -5$ mA to -1 A $P_o \leq 15$ W $V_i = -24$ to -35 V	-19	-20	-21	V
ΔV_o^*	Line Regulation	$V_i = -23$ to -35 V $T_j = 25$ °C $V_i = -26$ to -32 V $T_j = 25$ °C			400 200	mV mV
ΔV_o^*	Load Regulation	$I_o = 5$ to 1500 mA $T_j = 25$ °C $I_o = 250$ to 750 mA $T_j = 25$ °C			400 200	mV mV
I_d	Quiescent Current	$T_j = 25$ °C			3	mA
ΔI_d	Quiescent Current Change	$I_o = 5$ to 1000 mA			0.5	mA
ΔI_d	Quiescent Current Change	$V_i = -24$ to -35 V			1	mA
$\frac{\Delta V_o}{\Delta T}$	Output Voltage Drift	$I_o = 5$ mA		-1.1		mV/°C
e_N	Output Noise Voltage	$B = 10$ Hz to 100 KHz $T_j = 25$ °C		350		μV
SVR	Supply Voltage Rejection	$\Delta V_i = 10$ V $f = 120$ Hz	54	60		dB
V_d	Dropout Voltage	$I_o = 1$ A $T_j = 25$ °C $\Delta V_o = 100$ mV		1.1		V
I_{sc}	Short Circuit Current			0.9		A
I_{scp}	Short Circuit Peak Current	$T_j = 25$ °C		2.5		A

* Load and line regulation are specified at constant junction temperature. Changes in V_o due to heating effects must be taken into account separately. Pulse testing with low duty cycle is used.

ELECTRICAL CHARACTERISTICS FOR L7922C (refer to the test circuits, $T_j = 0$ to 150 °C, $V_i = -31V$, $I_o = 500$ mA, $C_i = 2.2$ μF , $C_o = 1$ μF unless otherwise specified)

Symbol	Parameter	Test Conditions	Min.	Typ.	Max.	Unit
V_o	Output Voltage	$T_j = 25$ °C	-21.1	-22	-22.9	V
V_o	Output Voltage	$I_o = -5$ mA to -1 A $P_o \leq 15$ W $V_i = -26$ to -37 V	-20.9	-22	-23.1	V
ΔV_o^*	Line Regulation	$V_i = -25$ to -37 V $T_j = 25$ °C $V_i = -28$ to -34 V $T_j = 25$ °C			440 220	mV mV
ΔV_o^*	Load Regulation	$I_o = 5$ to 1500 mA $T_j = 25$ °C $I_o = 250$ to 750 mA $T_j = 25$ °C			440 220	mV mV
I_d	Quiescent Current	$T_j = 25$ °C			3	mA
ΔI_d	Quiescent Current Change	$I_o = 5$ to 1000 mA			0.5	mA
ΔI_d	Quiescent Current Change	$V_i = -26$ to -37 V			1	mA
$\frac{\Delta V_o}{\Delta T}$	Output Voltage Drift	$I_o = 5$ mA		-1.1		mV/°C
e_N	Output Noise Voltage	$B = 10$ Hz to 100 KHz $T_j = 25$ °C		375		μV
SVR	Supply Voltage Rejection	$\Delta V_i = 10$ V $f = 120$ Hz	54	60		dB
V_d	Dropout Voltage	$I_o = 1$ A $T_j = 25$ °C $\Delta V_o = 100$ mV		1.1		V
I_{sc}	Short Circuit Current			1.1		A
I_{scp}	Short Circuit Peak Current	$T_j = 25$ °C		2.2		A

ELECTRICAL CHARACTERISTICS FOR L7924C (refer to the test circuits, $T_j = 0$ to 150 °C, $V_i = -33V$, $I_o = 500$ mA, $C_i = 2.2$ μF , $C_o = 1$ μF unless otherwise specified)

Symbol	Parameter	Test Conditions	Min.	Typ.	Max.	Unit
V_o	Output Voltage	$T_j = 25$ °C	-23	-24	-25	V
V_o	Output Voltage	$I_o = -5$ mA to -1 A $P_o \leq 15$ W $V_i = -27$ to -38 V	-22.8	-24	-25.2	V
ΔV_o^*	Line Regulation	$V_i = -27$ to -38 V $T_j = 25$ °C $V_i = -30$ to -36 V $T_j = 25$ °C			480 240	mV mV
ΔV_o^*	Load Regulation	$I_o = 5$ to 1500 mA $T_j = 25$ °C $I_o = 250$ to 750 mA $T_j = 25$ °C			480 240	mV mV
I_d	Quiescent Current	$T_j = 25$ °C			3	mA
ΔI_d	Quiescent Current Change	$I_o = 5$ to 1000 mA			0.5	mA
ΔI_d	Quiescent Current Change	$V_i = -27$ to -38 V			1	mA
$\frac{\Delta V_o}{\Delta T}$	Output Voltage Drift	$I_o = 5$ mA		-1		mV/°C
e_N	Output Noise Voltage	$B = 10$ Hz to 100 KHz $T_j = 25$ °C		400		μV
SVR	Supply Voltage Rejection	$\Delta V_i = 10$ V $f = 120$ Hz	54	60		dB
V_d	Dropout Voltage	$I_o = 1$ A $T_j = 25$ °C $\Delta V_o = 100$ mV		1.1		V
I_{sc}	Short Circuit Current			1.1		A
I_{scp}	Short Circuit Peak Current	$T_j = 25$ °C		2.2		A

* Load and line regulation are specified at constant junction temperature. Changes in V_o due to heating effects must be taken into account separately. Pulse testing with low duty cycle is used.

L7900 SERIES

APPLICATION INFORMATION

Figure 1 : Fixed Output Regulator.

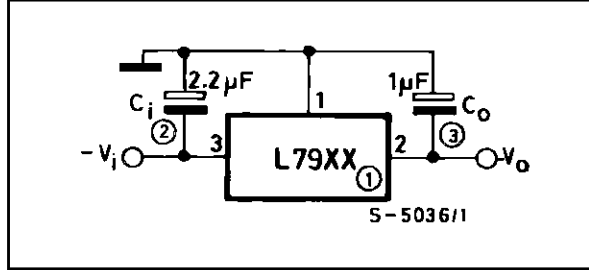

- Notes :**
1. To specify an output voltage, substitute voltage value for "XX".
 2. Required for stability. For value given, capacitor must be solid tantalum. If aluminium electrolytics are used, at least ten times value should be selected. C₁ is required if regulator is located an appreciable distance from power supply filter.
 3. To improve transient response. If large capacitors are used, a high current diode from input to output (1N4001 or similar) should be introduced to protect the device from momentary input short circuit.

Figure 2 : Split Power Supply (± 15V/1A).

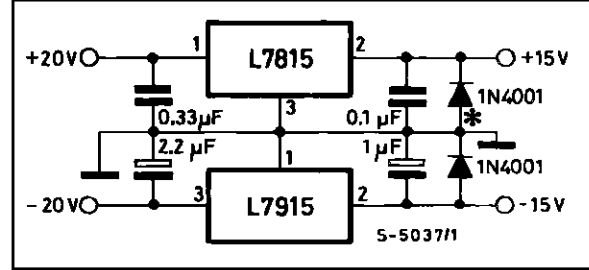

* Against potential latch-up problems.

Figure 3 : Circuit for Increasing Output Voltage.

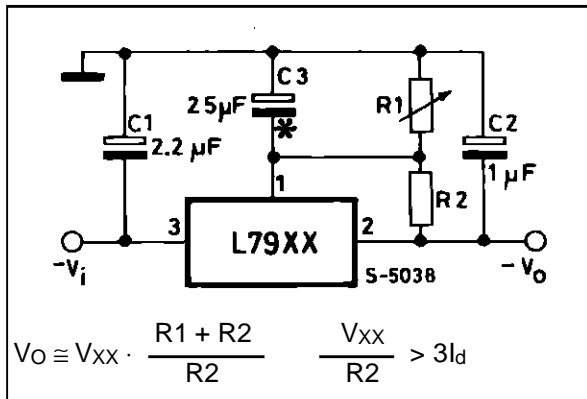

* C₃ Optional for improved transient response and ripple rejection.

Figure 4 : High Current Negative Regulator (-5V/4A with 5A current limiting).

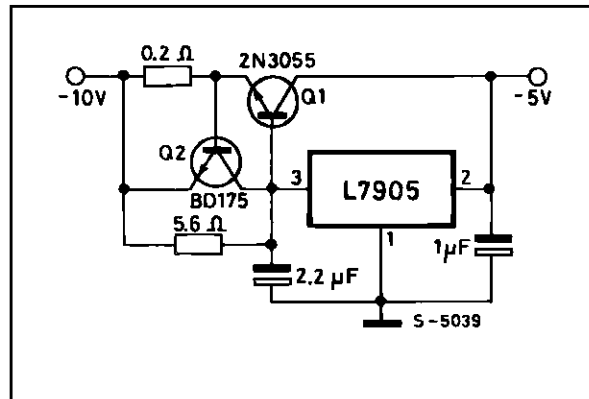
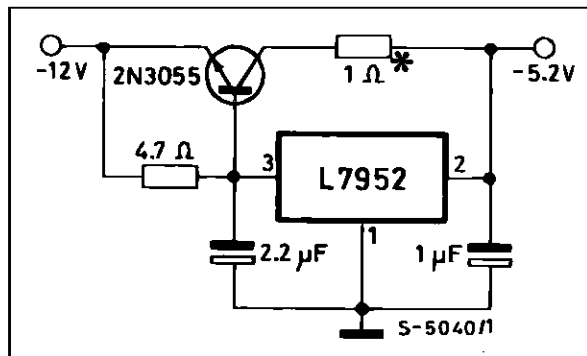

Figure 5 : Typical ECL System Power Supply (-5.2V/4A).



* Optional dropping resistor to reduce the power dissipated in the boost transistor.

TO-3 MECHANICAL DATA

DIM.	mm			inch		
	MIN.	TYP.	MAX.	MIN.	TYP.	MAX.
A	11.00		13.10	0.433		0.516
B	0.97		1.15	0.038		0.045
C	1.50		1.65	0.059		0.065
D	8.32		8.92	0.327		0.351
E	19.00		20.00	0.748		0.787
G	10.70		11.10	0.421		0.437
N	16.50		17.20	0.649		0.677
P	25.00		26.00	0.984		1.023
R	4.00		4.09	0.157		0.161
U	38.50		39.30	1.515		1.547
V	30.00		30.30	1.187		1.193

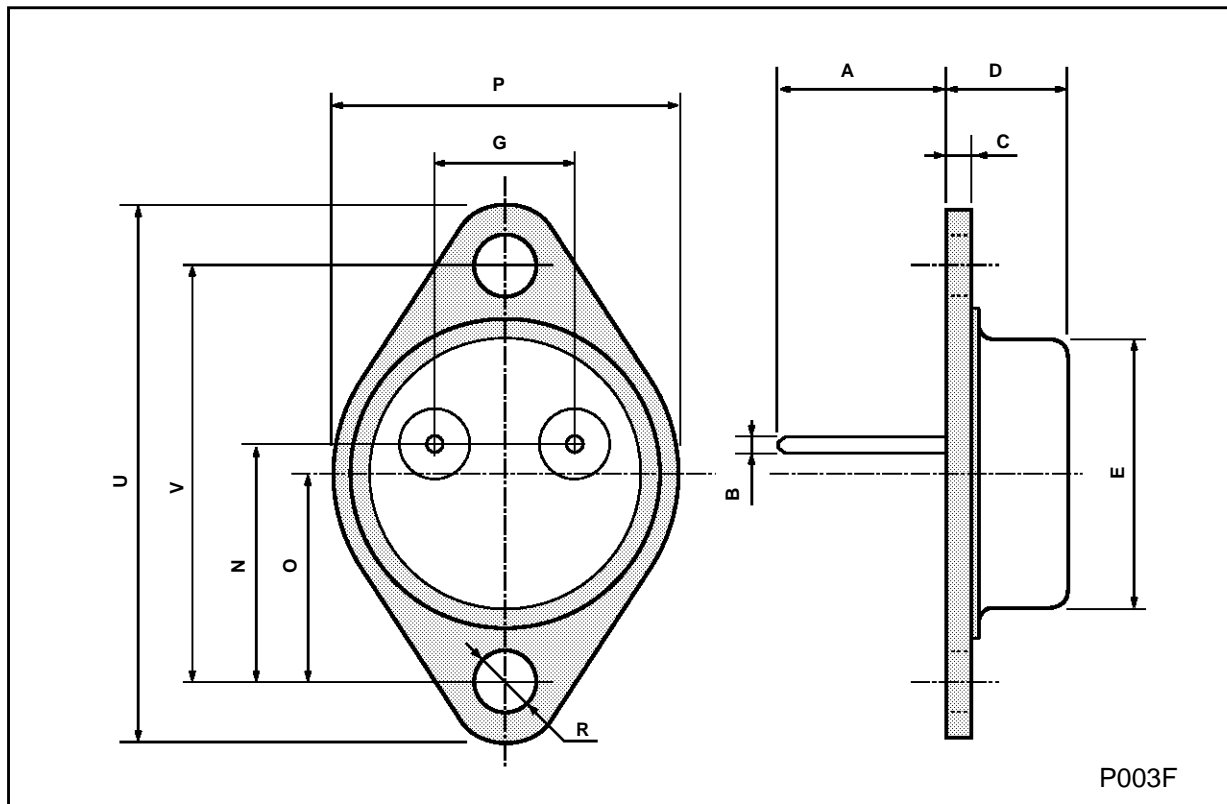

P003F

L7900 SERIES

TO-220 MECHANICAL DATA

DIM.	mm			inch		
	MIN.	TYP.	MAX.	MIN.	TYP.	MAX.
A	4.40		4.60	0.173		0.181
C	1.23		1.32	0.048		0.051
D	2.40		2.72	0.094		0.107
D1		1.27			0.050	
E	0.49		0.70	0.019		0.027
F	0.61		0.88	0.024		0.034
F1	1.14		1.70	0.044		0.067
F2	1.14		1.70	0.044		0.067
G	4.95		5.15	0.194		0.203
G1	2.4		2.7	0.094		0.106
H2	10.0		10.40	0.393		0.409
L2		16.4			0.645	
L4	13.0		14.0	0.511		0.551
L5	2.65		2.95	0.104		0.116
L6	15.2		15.9	0.598		0.625
L7	6.2		6.6	0.244		0.260
L9	3.5		4.2	0.137		0.165
DIA.	3.75		3.85	0.147		0.151

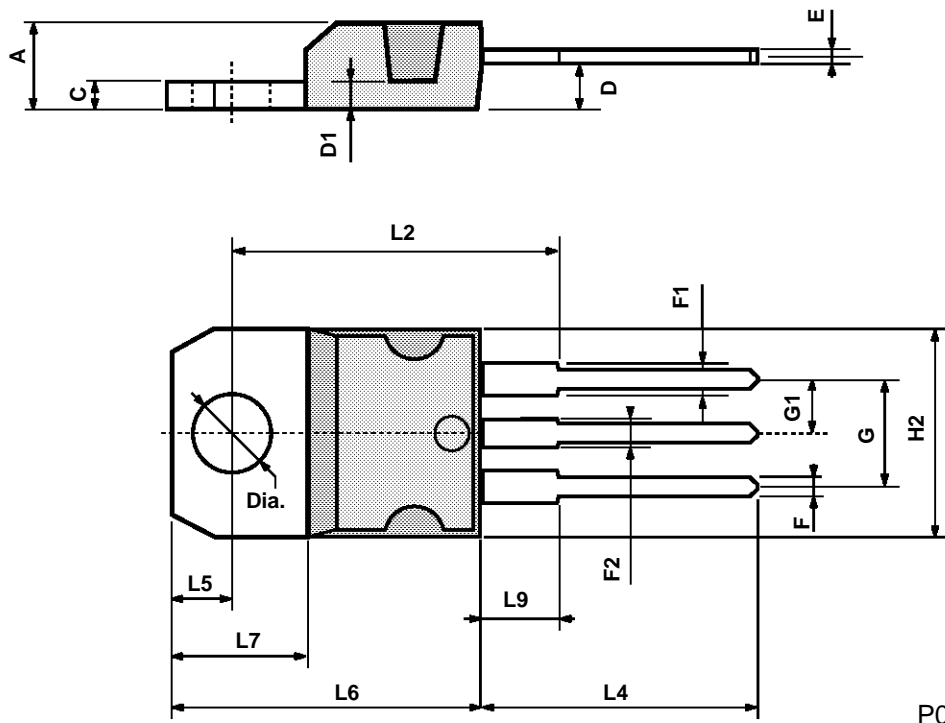

P011C

ISOWATT220 MECHANICAL DATA

DIM.	mm			inch		
	MIN.	TYP.	MAX.	MIN.	TYP.	MAX.
A	4.4		4.6	0.173		0.181
B	2.5		2.7	0.098		0.106
D	2.5		2.75	0.098		0.108
E	0.4		0.7	0.015		0.027
F	0.75		1	0.030		0.039
F1	1.15		1.7	0.045		0.067
F2	1.15		1.7	0.045		0.067
G	4.95		5.2	0.195		0.204
G1	2.4		2.7	0.094		0.106
H	10		10.4	0.393		0.409
L2		16			0.630	
L3	28.6		30.6	1.126		1.204
L4	9.8		10.6	0.385		0.417
L6	15.9		16.4	0.626		0.645
L7	9		9.3	0.354		3.66
∅	3		3.2	0.118		0.126

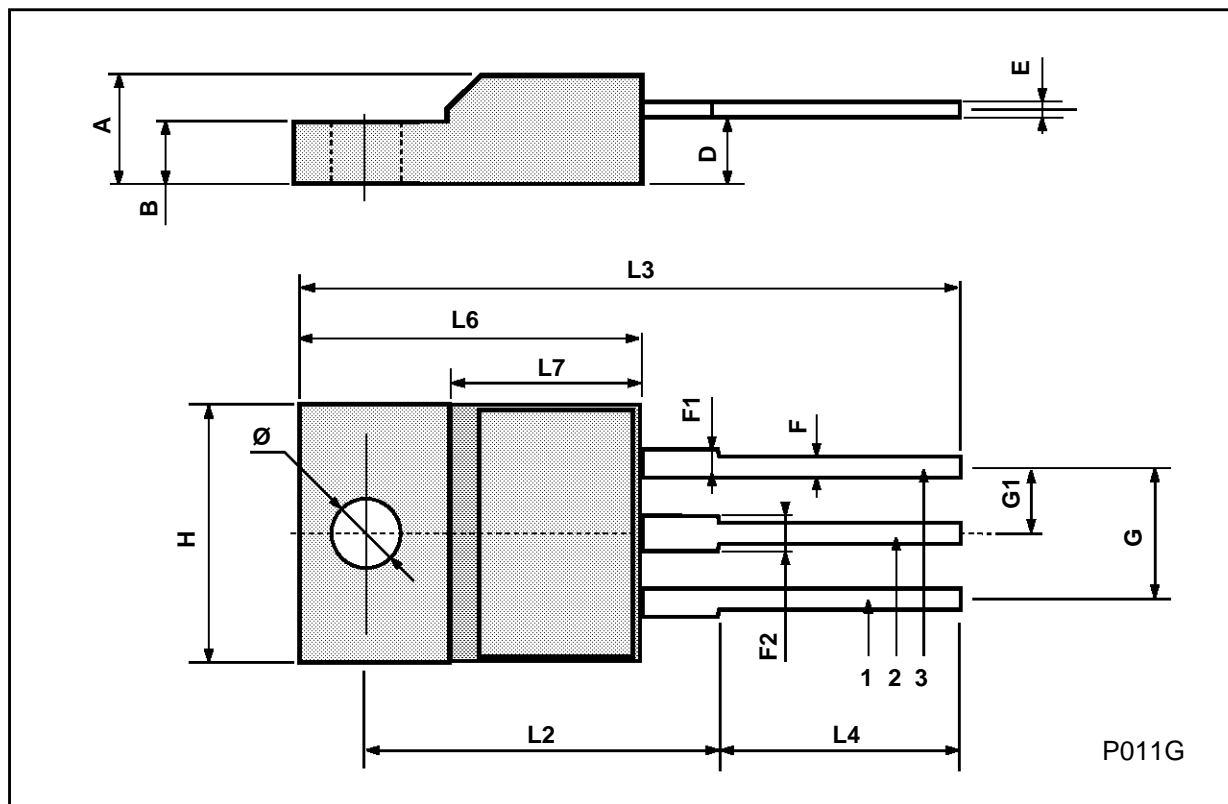

L7900 SERIES

Information furnished is believed to be accurate and reliable. However, SGS-THOMSON Microelectronics assumes no responsibility for the consequences of use of such information nor for any infringement of patents or other rights of third parties which may result from its use. No license is granted by implication or otherwise under any patent or patent rights of SGS-THOMSON Microelectronics. Specifications mentioned in this publication are subject to change without notice. This publication supersedes and replaces all information previously supplied. SGS-THOMSON Microelectronics products are not authorized for use as critical components in life support devices or systems without express written approval of SGS-THOMSON Microelectronics.

© 1994 SGS-THOMSON Microelectronics - All Rights Reserved

SGS-THOMSON Microelectronics GROUP OF COMPANIES

Australia - Brazil - France - Germany - Hong Kong - Italy - Japan - Korea - Malaysia - Malta - Morocco - The Netherlands -
Singapore - Spain - Sweden - Switzerland - Taiwan - Thailand - United Kingdom - U.S.A