

- GLASS PASSIVATED CHIP
- EXCELLENT $(dv/dt)_c > 10 \text{ V}/\mu\text{s}$
- I_{GT} SPECIFIED IN FOUR QUADRANTS
- AVAILABLE IN INSULATED VERSION → BTA SERIES (INSULATING VOLTAGE 2500 V_{RMS}) OR IN UNINSULATED VERSION → BTB SERIES
- UL RECOGNIZED FOR BTA SERIES (E81734)

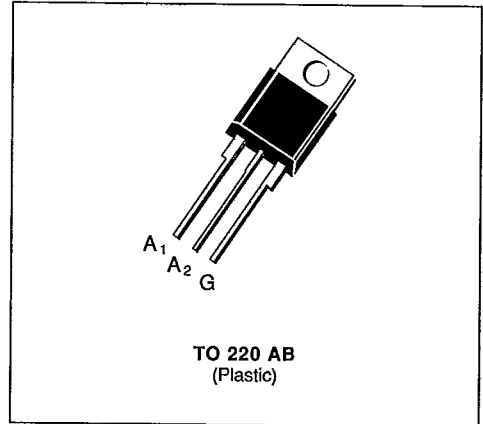

DESCRIPTION

New range suited for applications such as phase control and static switching.

ABSOLUTE RATINGS (limiting values)

Symbol	Parameter		Value	Unit
$I_{T(RMS)}$	RMS on-state Current (360° conduction angle)	$T_C = 75 \text{ }^\circ\text{C}$	8	A
I_{TSM}	Non Repetitive Surge Peak on-state Current (T_J initial = 25 °C - Half sine wave)	$t = 8.3 \text{ ms}$	84	A
		$t = 10 \text{ ms}$	80	
I^2t	I^2t Value for Fusing	$t = 10 \text{ ms}$	32	A ² s
di/dt	Critical Rate of Rise of on-state Current (1)	Repetitive $F = 50 \text{ Hz}$	10	A/ μs
		Non Repetitive	50	
T_{stg} T_J	Storage and Operating Junction Temperature Range		- 40 to 150 - 40 to 110	$^\circ\text{C}$ $^\circ\text{C}$

Symbol	Parameter	BTA/BTB 08-					Unit
		200B	400B	600B	700B	800B	
V_{DRM}	Repetitive Peak off-state Voltage (2)	200	400	600	700	800	V

(1) $I_G = 1 \text{ A}$ $di/dt = 1 \text{ A}/\mu\text{s}$
 (2) $T_J = 110 \text{ }^\circ\text{C}$.

THERMAL RESISTANCES

Symbol	Parameter	Value	Unit
$R_{th(j-a)}$	Junction to Ambient	60	$^\circ\text{C}/\text{W}$
$R_{th(j-c)} \text{ DC}$	Junction to Case for DC	4.3	$^\circ\text{C}/\text{W}$
$R_{th(j-c)} \text{ AC}$	Junction to Case for 360° Conduction Angle ($F = 50 \text{ Hz}$)	3.2	$^\circ\text{C}/\text{W}$

GATE CHARACTERISTICS (maximum values)

$P_{GM} = 40 \text{ W}$ ($t_p = 10 \mu\text{s}$) $I_{GM} = 4 \text{ A}$ ($t_p = 10 \mu\text{s}$)
 $P_{G(AV)} = 1 \text{ W}$ $V_{GM} = 16 \text{ V}$ ($t_p = 10 \mu\text{s}$)

T-25-15

ELECTRICAL CHARACTERISTICS

Symbol	Test Conditions	Quadrants	Min..	Typ.	Max.	Unit
I_{GT}	$T_j = 25 \text{ }^\circ\text{C}$ $V_D = 12 \text{ V}$ $R_L = 33 \text{ } \Omega$ Pulse Duration > 20 μs	I-II-III			50	mA
		IV			100	
V_{GT}	$T_j = 25 \text{ }^\circ\text{C}$ $V_D = 12 \text{ V}$ $R_L = 33 \text{ } \Omega$ Pulse Duration > 20 μs	I-II-III-IV			1.5	V
V_{GD}	$T_j = 110 \text{ }^\circ\text{C}$ $V_D = V_{DRM}$ $R_L = 3.3 \text{ k}\Omega$	I-II-III-IV	0.2			V
I_{H}^*	$T_j = 25 \text{ }^\circ\text{C}$ $I_T = 100 \text{ mA}$ Gate Open				50	mA
I_L	$T_j = 25 \text{ }^\circ\text{C}$ $V_D = 12 \text{ V}$ $I_G = 200 \text{ mA}$ Pulse Duration > 20 μs	I-III-IV		50		mA
		II		100		
V_{TM}^*	$T_j = 25 \text{ }^\circ\text{C}$ $I_{TM} = 11 \text{ A}$ $t_p = 10 \text{ ms}$				1.75	V
I_{DRM}^*	V_{DRM} Specified			$T_j = 25 \text{ }^\circ\text{C}$	0.01	mA
				$T_j = 110 \text{ }^\circ\text{C}$	0.5	
dv/dt^*	$T_j = 110 \text{ }^\circ\text{C}$ Gate Open Linear Slope up to $V_D = 67\% V_{DRM}$		250	500		V/ μs
$(dv/dt)_o^*$	$T_C = 75 \text{ }^\circ\text{C}$ $V_D = V_{DRM}$ $I_T = 11 \text{ A}$ $(di/dt)_o = 3.5 \text{ A/ms}$		10			V/ μs
t_{gt}	$T_j = 25 \text{ }^\circ\text{C}$ $V_D = V_{DRM}$ $I_T = 11 \text{ A}$ $I_G = 80 \text{ mA}$ $di_G/dt = 1 \text{ A}/\mu\text{s}$	I-II-III-IV		2		μs

* For either polarity of electrode A₂ voltage with reference to electrode A₁.

PACKAGE MECHANICAL DATA

TO 220 AB Plastic

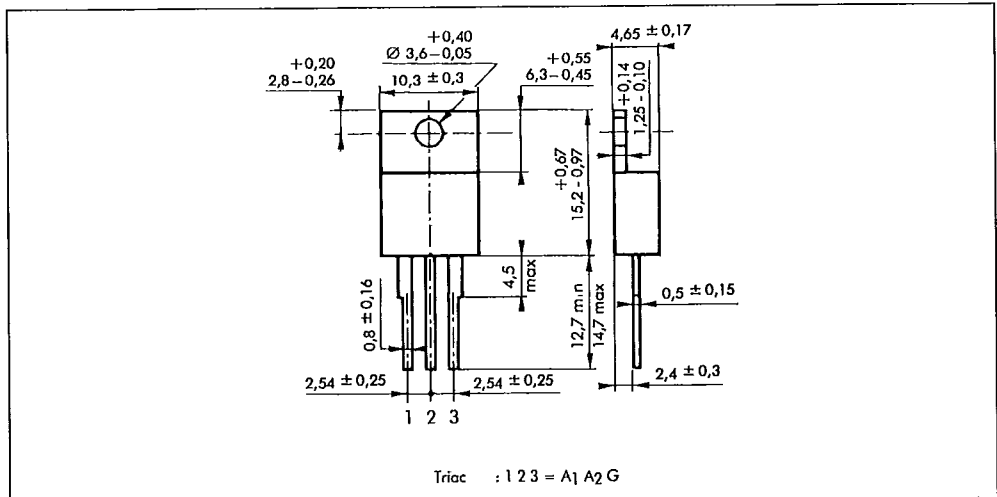

Cooling method : by conduction (method C)
 Marking : type number
 Weight : 2 g.

T-25-15

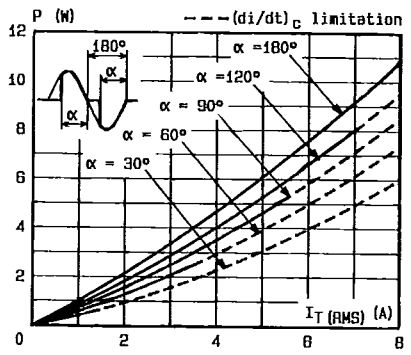

Fig.1 - Maximum mean power dissipation versus RMS on-state current (F = 60 Hz).

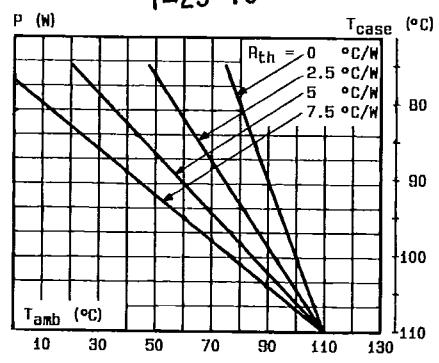

Fig.2 - Correlation between maximum mean power dissipation and maximum allowable temperatures (T_{amb} and T_{case}) for different thermal resistances heatsink + contact.

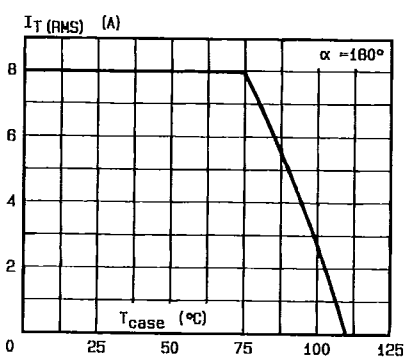

Fig.3 - RMS on-state current versus case temperature.

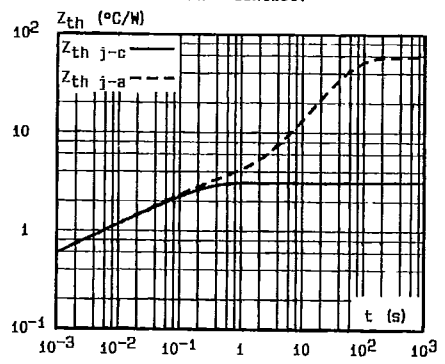

Fig.4 - Thermal transient impedance junction to case and junction to ambient versus pulse duration.

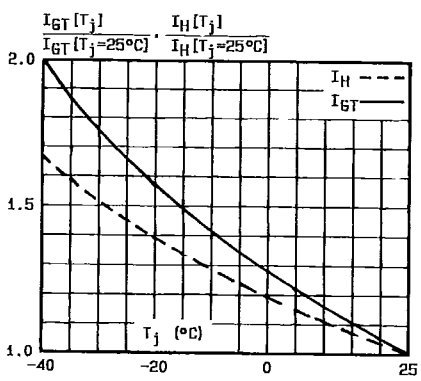

Fig.5 - Relative variation of gate trigger current and holding current versus junction temperature.

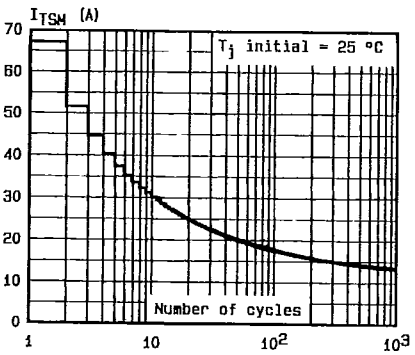

Fig.6 - Non repetitive surge peak on-state current versus number of cycles.

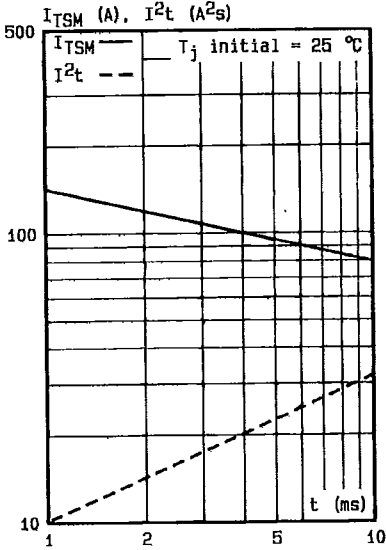

Fig.7 - Non repetitive surge peak on-state current for a sinusoidal pulse with width : $t \leq 10$ ms, and corresponding value of I^2t .

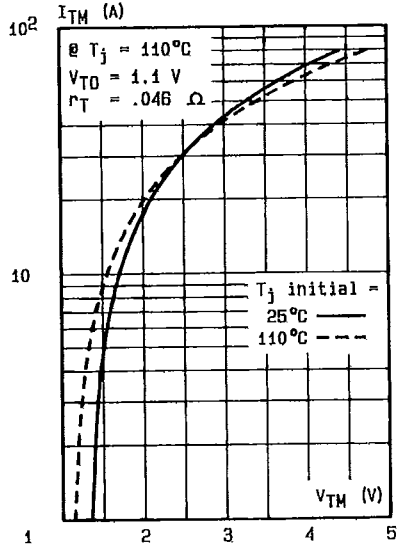

Fig.8 - On-state characteristics (maximum values).