



## LM393

## LINEAR INTEGRATED CIRCUIT

### DUAL DIFFERENTIAL COMPARATOR

#### DESCRIPTION

The UTC **LM393** consists of two independent voltage comparators, designed specifically to operate from a single power supply over a wide voltage range.

#### FEATURES

- \* Single or dual supply operation.
- \* Wide operating supply range ( $V_{CC}=2V \sim 36V$  or  $\pm 1 \sim \pm 18V$ )
- \* Input common-mode voltage includes ground.
- \* Low supply current drain  $I_{CC}=0.8mA$  (Typical).
- \* Low input bias current  $I_{BIAS}=25nA$  (Typical).
- \* Output compatible with TTL, DTL, and CMOS logic system.

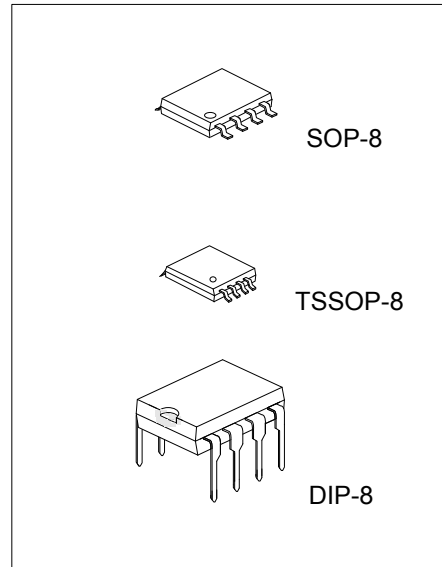

Lead-free: LM393L  
Halogen-free: LM393G

#### ORDERING INFORMATION

Ordering Number			Package	Packing
Normal	Lead Free Plating	Halogen-Free		
LM393-D08-T	LM393L-D08-T	LM393G-D08-T	DIP-8	Tube
LM393-P08-R	LM393L-P08-R	LM393G-P08-R	TSSOP-8	Tape Reel
LM393-S08-R	LM393L-S08-R	LM393G-S08-R	SOP-8	Tape Reel

<p>LM393L-D08-R</p> <p>(1)Packing Type (2)Package Type (3)Lead Plating</p>	<p>(1) R: Tape Reel, T: Tube (2) D08: DIP-8, P08: TSSOP-8, S08: SOP-8 (3) G: Halogen Free, L: Lead Free Plating, Blank: Pb/Sn</p>
--	---

### ■ PIN DESCRIPTION

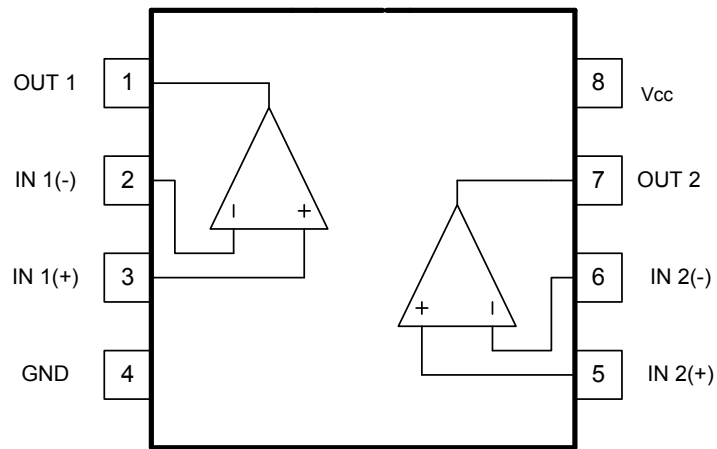

## ■ BLOCK DIAGRAM

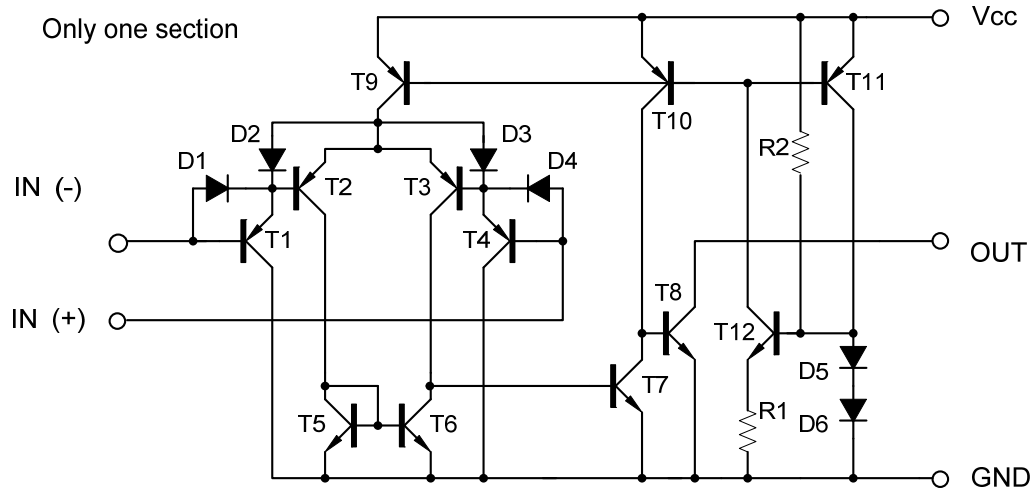

### ■ ABSOLUTE MAXIMUM RATINGS

PARAMETER	SYMBOL	RATINGS	UNIT
Supply Voltage	$V_{CC}$	$\pm 18$ or 36	V
Differential Input Voltage	$V_{I(DIFF)}$	36	V
Input Voltage	$V_{IN}$	-0.3 ~ +36	V
Power Dissipation	$P_D$	570	mW
Operating Temperature Range	$T_{OPR}$	-20 ~ +85	°C
Storage Temperature Range	$T_{STG}$	-65 ~ +150	°C

Note: Absolute maximum ratings are those values beyond which the device could be permanently damaged. Absolute maximum ratings are stress ratings only and functional device operation is not implied.

### ■ ELECTRICAL CHARACTERISTICS

( $V_{CC}=5.0V$ ,  $T_a=25^\circ C$ , All voltage referenced to GND unless otherwise specified)

PARAMETER	SYMBOL	TEST CONDITIONS	MIN	TYP	MAX	UNIT
Input Offset Voltage	$V_{I(OFF)}$	$V_{CM}=0V$ to $V_{CC}-1.5V$ $V_{O(P)}=1.4V$ , $R_S=0\Omega$		1.0	5.0	mV
Output Saturation Voltage	$V_{SAT}$	$V_{I(-)}>1V$ , $V_{I(+)}=0V$ , $I_{SINK}=4mA$		160	400	mV
Input Common Mode Voltage	$V_{I(CM)}$	$V_{CC}=30V$	0		$V_{CC}-1.5$	V
Large Signal Voltage Gain	$G_V$	$V_{CC}=15V$ , $R_L \geq 15K\Omega$	50	200		V/mV
Power Supply Current	$I_{CC}$	$R_L=\infty$ , $V_{CC}=30V$		0.8	2.5	mA
		$R_L=\infty$		0.6	1.0	mA
Input Offset Current	$I_{I(OFF)}$			5	50	nA
Input Bias Current	$I_{I(BIAS)}$			65	250	nA
Output Sink Current	$I_{O(SINK)}$	$V_{I(-)}>1V$ , $V_{I(+)}=0V$ , $V_{O(P)}<1.5V$	6	18		mA
Output Leakage Current	$I_{O(LEAK)}$	$V_{I(+)}=1V$ , $V_{I(-)}=0$		0.1		nA
		$V_{O(P)}=30V$			1.0	$\mu A$
Large Signal Response Time	$t_R$	$V_{IN}$ =TTL logic wing $V_{REF}=1.4V$ , $V_{RL}=5V$ , $R_L=5.1k\Omega$		350		ns
Response Time	$t_R$	$V_{RL}=5V$ , $R_L=5.1k\Omega$		1400		ns

## TYPICAL CHARACTERISTICS

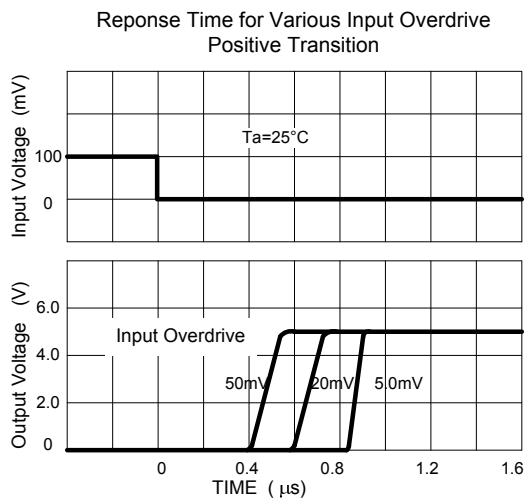
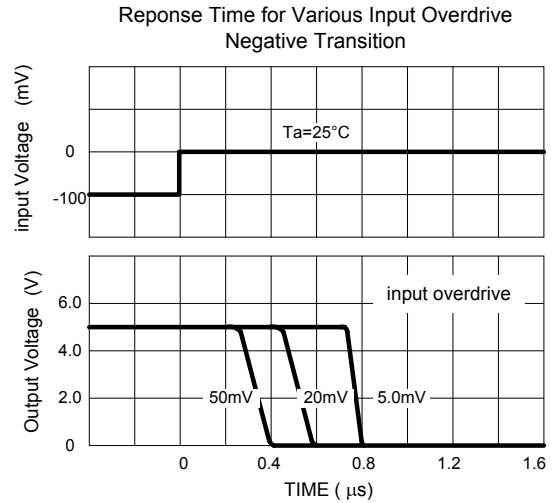
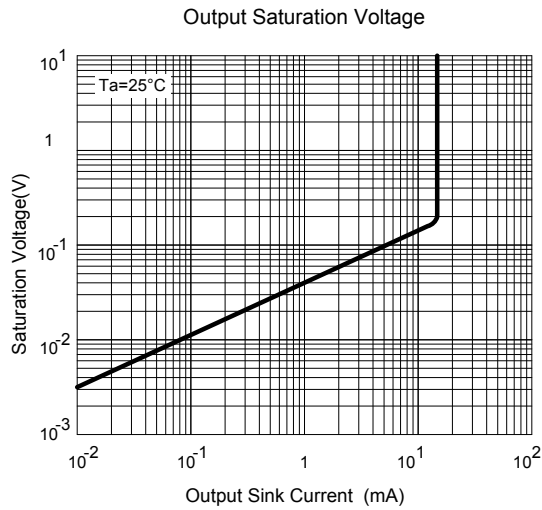
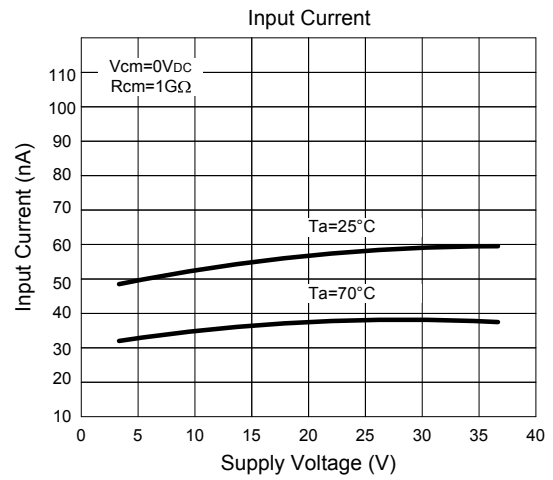
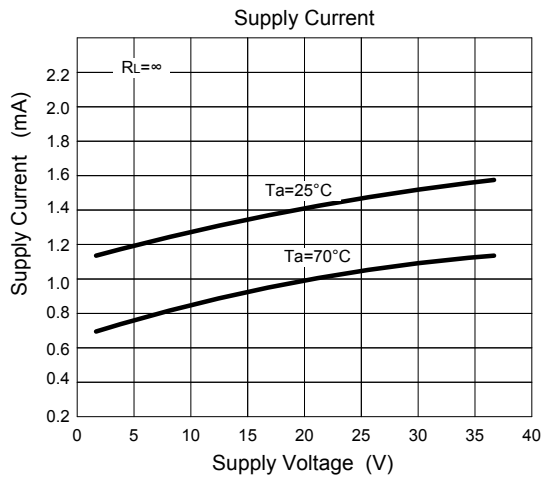

## TYPICAL CHARACTERISTICS(Cont.)

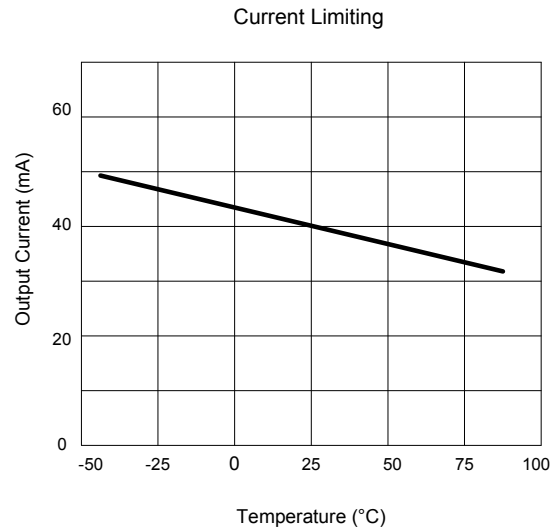
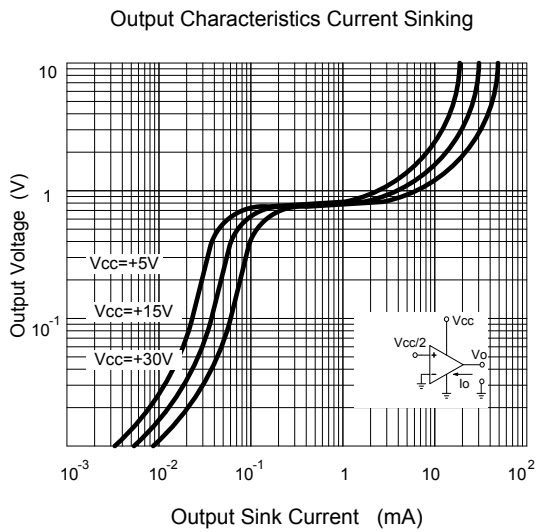
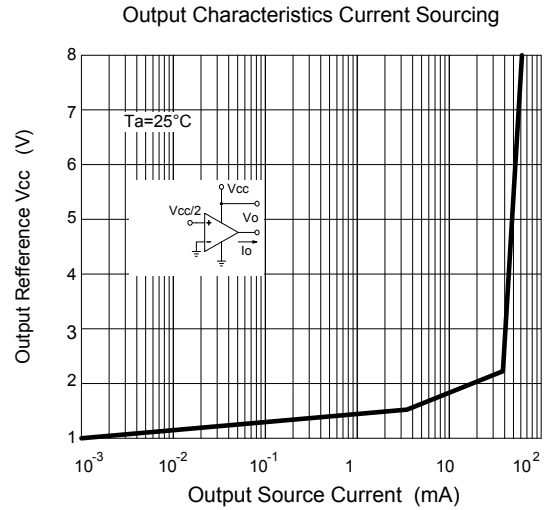
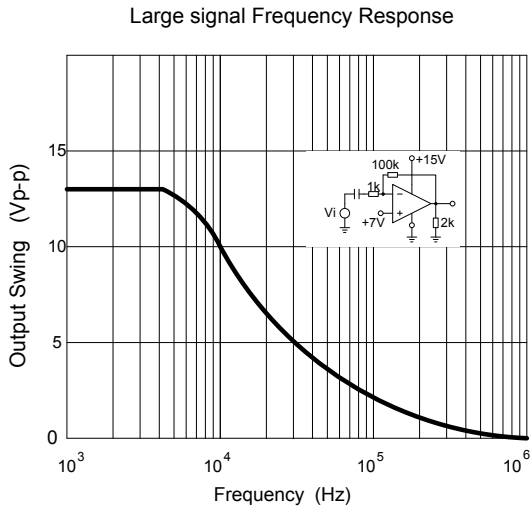
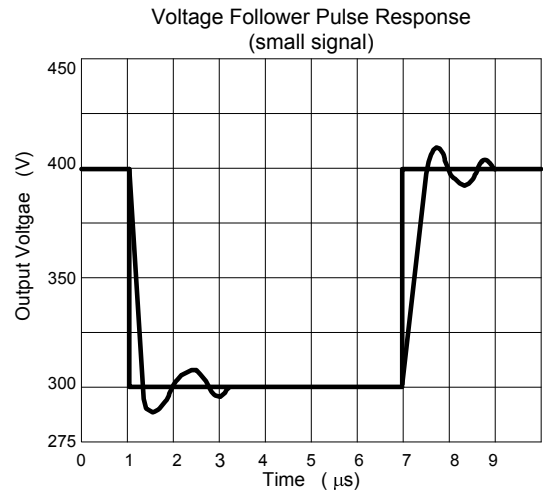
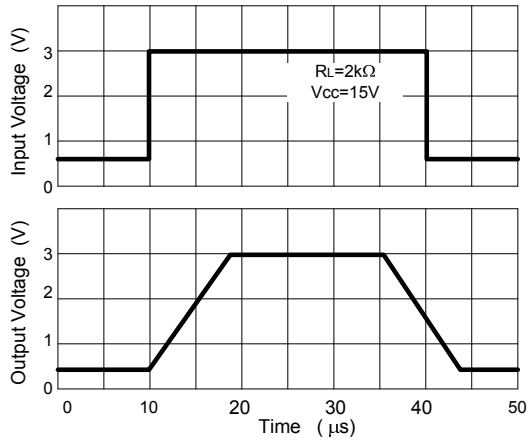

UTC assumes no responsibility for equipment failures that result from using products at values that exceed, even momentarily, rated values (such as maximum ratings, operating condition ranges, or other parameters) listed in products specifications of any and all UTC products described or contained herein. UTC products are not designed for use in life support appliances, devices or systems where malfunction of these products can be reasonably expected to result in personal injury. Reproduction in whole or in part is prohibited without the prior written consent of the copyright owner. The information presented in this document does not form part of any quotation or contract, is believed to be accurate and reliable and may be changed without notice.