

CUSTOMER : _____.

DATE : 2012. 3. 29.

SPECIFICATIONS FOR APPROVAL



Top View Type White SMD LED

MODEL NAME : LEMWS59Q80LZ10

APPROVAL	REMARK	APPENDIX

Designed	Checked	Approved

SPECIFICATION

MODEL	LEMWS59Q80LZ10	DOCUMENT No	12(LIR)-H-09
REG.DATE	12.3.29	REV.No	1.0
REG.DATE	12.3.29	PAGE	2 / 20

Change History of Revision

Revision	Date	Contents of Revision Change	Remark
Rev. 1.0	'12.3.29	New establishment	

SPECIFICATION

MODEL	LEMWS59Q80LZ10	DOCUMENT No	12(LIR)-H-09
REG.DATE	12.3.29	REV.No	1.0
REG.DATE	12.3.29	PAGE	3 / 20

CONTENTS

1. Features -----	3
2. Outline dimensions -----	3
3. Applications -----	4
4. Absolute Maximum Ratings -----	4
5. Electro-Optical characteristics -----	4
6. Rank Sorting Method -----	5~6
7. Typical Characteristic Curves -----	7~8
8. Reliability Test Items and Conditions -----	9
9. Package and Marking of Products -----	10~14
10. Cautions on use -----	15~19
11. Others -----	20

SPECIFICATION

MODEL	LEMWS59Q80LZ10	DOCUMENT No	12(LIR)-H-09
REG.DATE	12.3.29	REV.No	1.0
REG.DATE	12.3.29	PAGE	4 / 20

1. Features

- Lighting Color : White (High CRI)
- Small size surface mount type : 5.6×3.0×0.9 mm (L×W×H)
- Viewing angle : extremely wide (120°)
- Chip Material : InGaN
- Soldering methods : IR reflow soldering
- Taping : 12 mm conductive black carrier tape & antistatic clear cover tape.
3,000pcs/reel, Φ178 mm wheel

2. Outline Dimensions

(unit : mm)

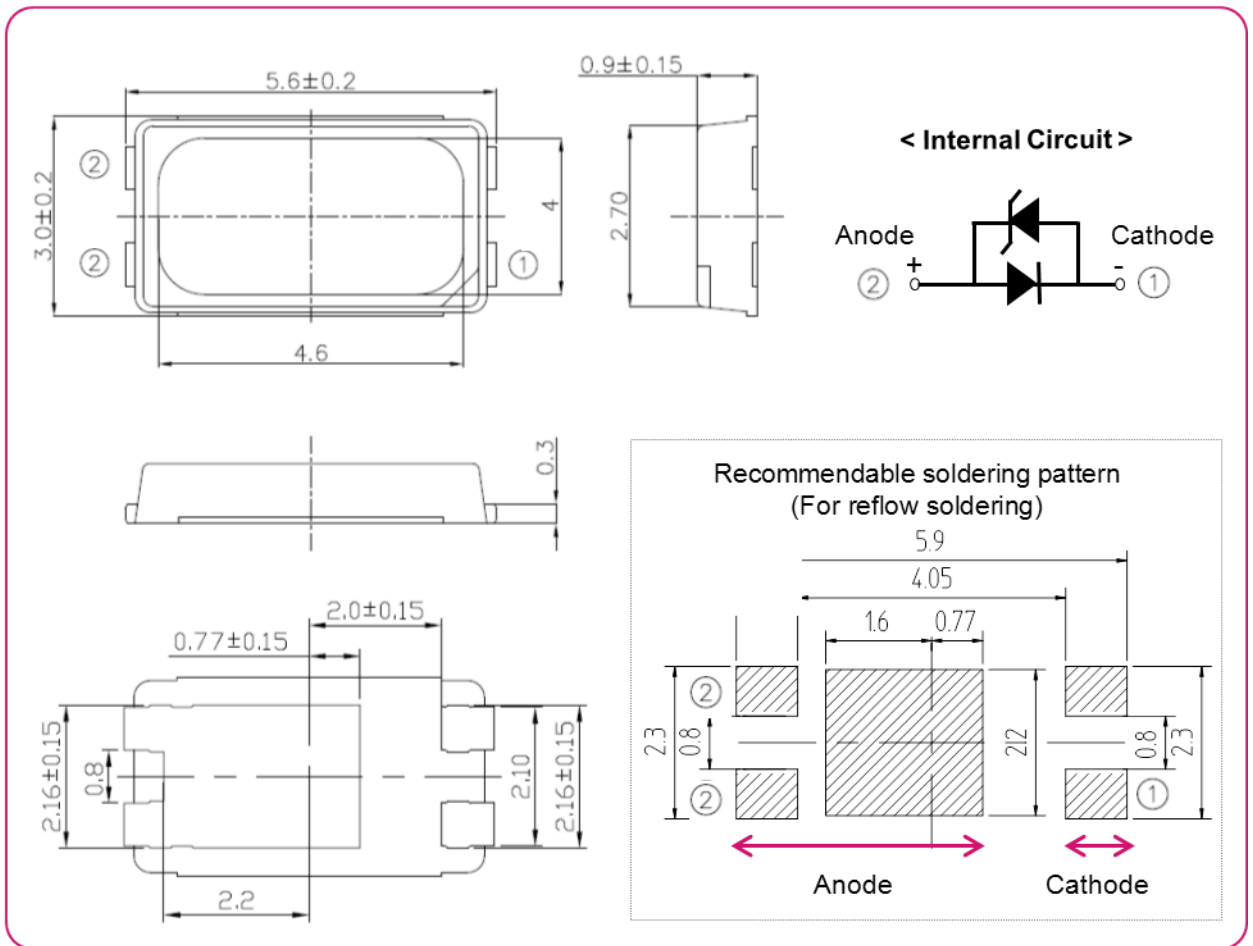

▪ Tolerances Unless Dimension ±0.1mm

SPECIFICATION

MODEL	LEMWS59Q80LZ10	DOCUMENT No	12(LIR)-H-09
REG.DATE	12.3.29	REV.No	1.0
REG.DATE	12.3.29	PAGE	5 / 20

3. Applications

- Interior and Exterior Illumination, Automotive Lighting

4. Absolute Maximum Ratings

(Ta=25°C)

Items	Symbols	Ratings	Unit
Forward Current	I_F	150	mA
Pulse Forward Current *1)	I_{FP}	260	mA
Power Dissipation	P_D	555	mW
Operating Temperature	T_{opr}	-30 ~ +85	°C
Storage Temperature	T_{stg}	-40 ~ +100	°C
Junction Temperature	T_j	110	°C

*1) Pulse Width = 10ms, $T_j < 80^\circ\text{C}$, Duty $\leq 10\%$,

5. Electro - Optical Characteristics

(Ta=25°C)

Items	Symbol	Condition	Min	Typ	Max	Unit
Forward Voltage	V_F	$I_F = 65[\text{mA}]$	2.8	-	3.2	V
Reverse Voltage (Zener Diode)*1)	V_R	$I_F = 10[\text{mA}]$	0.6	-	1.2	V
Luminous Flux	Φ_V	$I_F = 65[\text{mA}]$	21	23.5	-	lm
Luminous Intensity	I_v	$I_F = 65[\text{mA}]$	6.7	7.5	-	Cd
CIE Value	X / Y	$I_F = 65[\text{mA}]$	Refer to '6. Rank Sorting Method'			-
Viewing Angle	2 θ 1/2	$I_F = 65[\text{mA}]$	-	120	-	deg
Color Rendering Index	Ra	$I_F = 65[\text{mA}]$	80	-	-	-
Thermal resistance	R_{th}	$I_F = 65[\text{mA}]$	-	15	-	K/W
ESD	-	HBM	± 5	-	-	kV

*1) The value is based on performance of Zener Diode.

* Luminous Intensity (=Iv) : Only reference data.

※ These values measured by Optical Spectrum Analyzer of LG Innotek Co., LTD and tolerances are followings as below
 - Luminous Flux (Φ_V) : $\pm 10\%$, Forward Voltage(V_F) : ± 0.1 , CIE Value : ± 0.01 , CRI Value : ± 3

※ All PKG are tested by LG Innotek equipment. But, the values of characteristics of PKG could be changed slightly depend on the Test Equipment.

SPECIFICATION

MODEL	LEMWS59Q80LZ10	DOCUMENT No	12(LIR)-H-09
REG.DATE	12.3.29	REV.No	1.0
REG.DATE	12.3.29	PAGE	6 / 20

5. Electro - Optical Characteristics

If (mA)	Vf (V)	Power (W)	Flux (lm)	Lm/W
20	2.76	0.06	7.8	142
40	2.86	0.11	15.1	132
60	2.95	0.18	21.9	124
65(Typ.)	2.97	0.19	23.5	122
80	3.03	0.24	28.2	116
100	3.10	0.31	34.3	111
150	3.27	0.49	48.1	98

* Im values are representative references only.

6. Rank Sorting Method

▪ Rank of Forward Voltage (@ 65mA)

Rank	V _F (V, @ 65mA)		
	Min	Typ	Max
9	2.8	-	2.9
0	2.9	-	3.0
1	3.0	-	3.1
2	3.1	-	3.2

▪ Rank of Luminous Flux (@ 65mA)

Rank	Φ _V (lm, @ 65mA)		
	Min	Typ	Max
Q	21	23.5	-

▪ Rank of CRI (@ 65mA)

Rank	Ra (CRI, @ 65mA)		
	Min	Typ	Max
80	80	-	-

Rank name method : Please refer to the following example

Rank Name : Q – L2 – V2

Φ_V rank = Q, CIE rank = L2, V_F Rank = V2

* Voltages are tested at a current pulse duration of 10 ms and an accuracy of ± 5.0%.

* This categories are established for classification of products.

▪ Rank of CIE Value (@ 65mA)

CCT	Rank	CIE X	CIE Y
3000K (3045K ±195K)	L1	0.4299	0.4165
		0.4430	0.4212
		0.4344	0.4032
		0.4221	0.3984
		0.4221	0.3984
		0.4344	0.4032
	L2	0.4260	0.3853
		0.4147	0.3814
		0.4430	0.4212
		0.4562	0.4260
	L3	0.4465	0.4071
		0.4344	0.4032
		0.4344	0.4032
		0.4465	0.4071
	L4	0.4373	0.3893
		0.4260	0.3853
0.4373		0.3893	
0.4260		0.3853	

SPECIFICATION

MODEL	LEMWS59Q80LZ10	DOCUMENT No	12(LIR)-H-09
REG.DATE	12.3.29	REV.No	1.0
REG.DATE	12.3.29	PAGE	7 / 20

Chromaticity Diagram

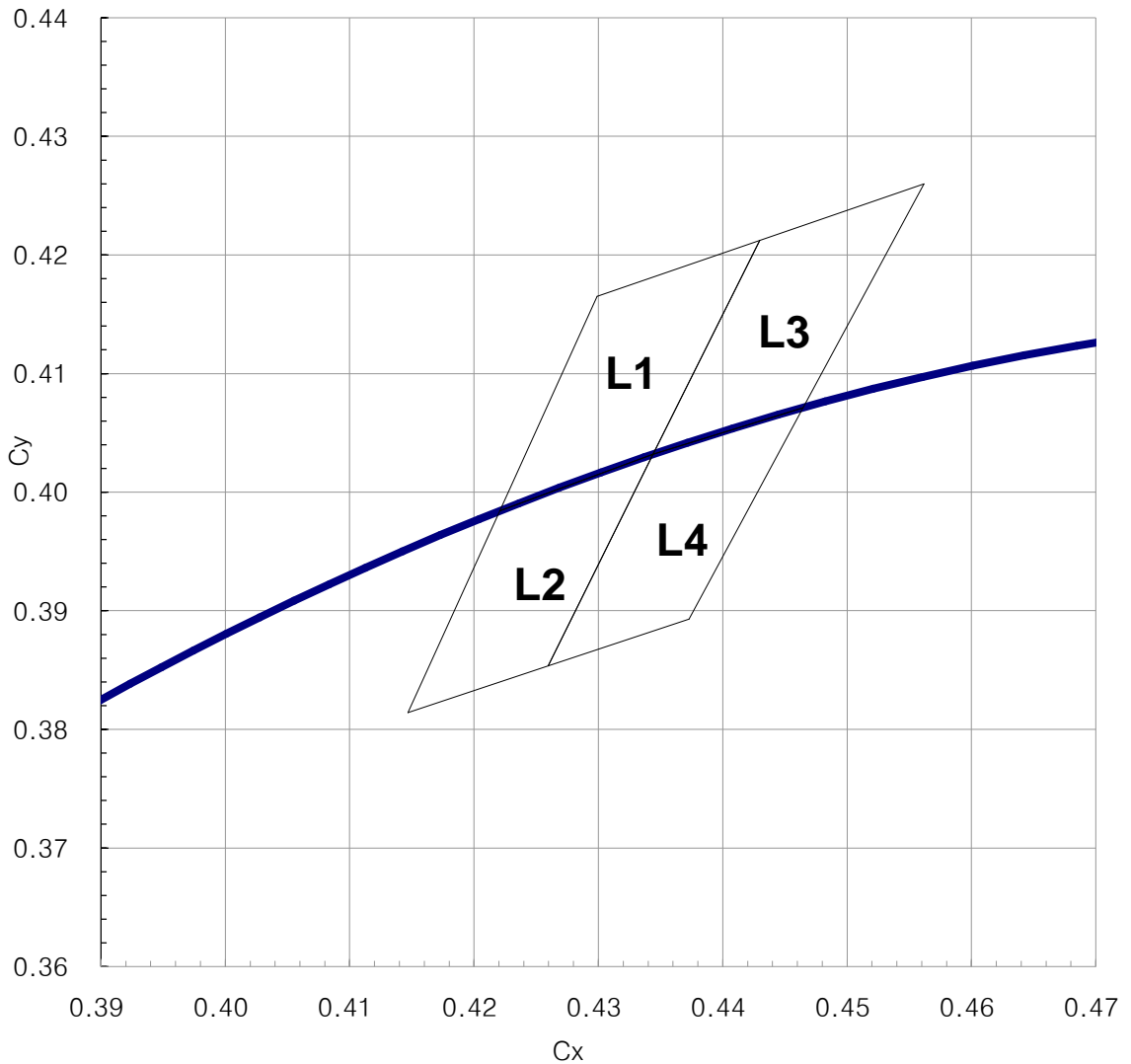

- Chromaticity coordinate groups are tested at a current pulse duration of 10 ms and a tolerance of ± 0.005 .
- This categories are established for classification of products.
- Color Coordinate is based on the CIE 1931 Chromaticity Diagram

SPECIFICATION

MODEL	LEMWS59Q80LZ10	DOCUMENT No	12(LIR)-H-09
REG.DATE	12.3.29	REV.No	1.0
REG.DATE	12.3.29	PAGE	8 / 20

7. Typical Characteristic Curves

▪ Forward Voltage vs. Forward Current

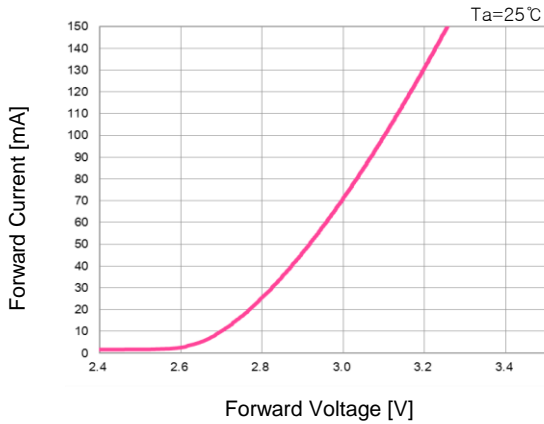

▪ Forward Current vs. Luminous Flux

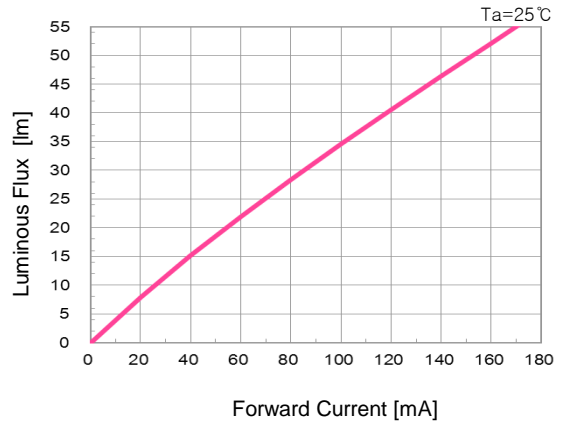

▪ Spectrum

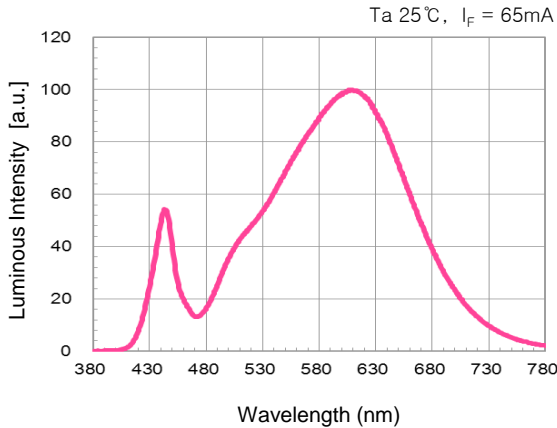

▪ Forward Current vs. CIE

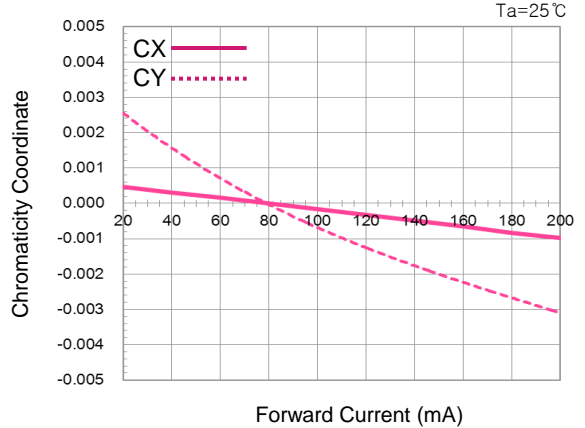

▪ Radiation Characteristics

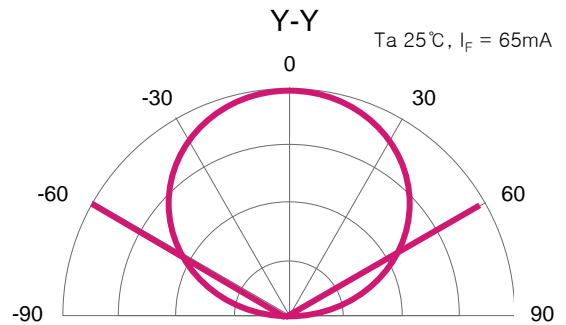
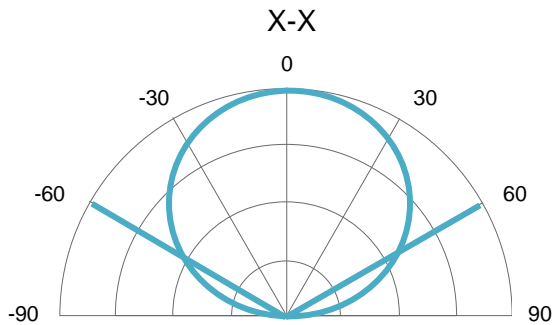

Relative Luminous Intensity

SPECIFICATION

MODEL	LEMWS59Q80LZ10	DOCUMENT No	12(LIR)-H-09
REG.DATE	12.3.29	REV.No	1.0
REG.DATE	12.3.29	PAGE	9 / 20

7. Typical Characteristic Curves

▪ Luminous Flux vs. Temp.

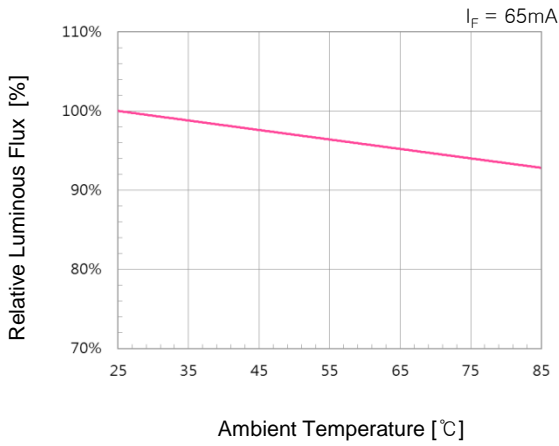

▪ CIE vs. Temp.

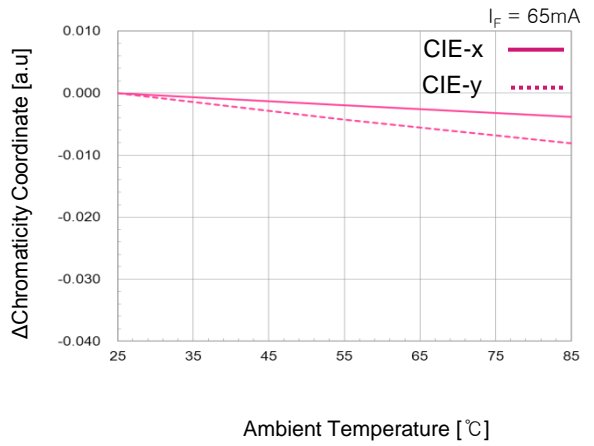

▪ V_F vs. Temp.

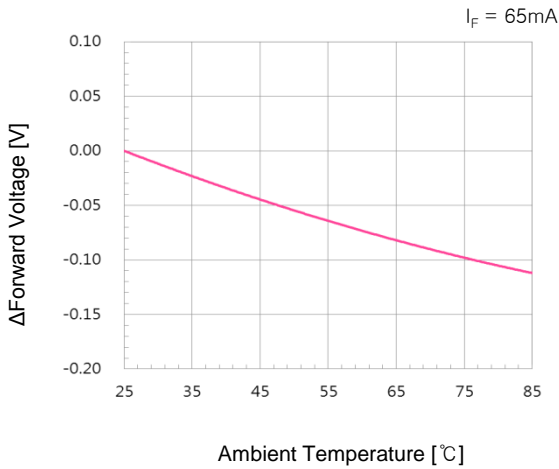

▪ Derating Curve

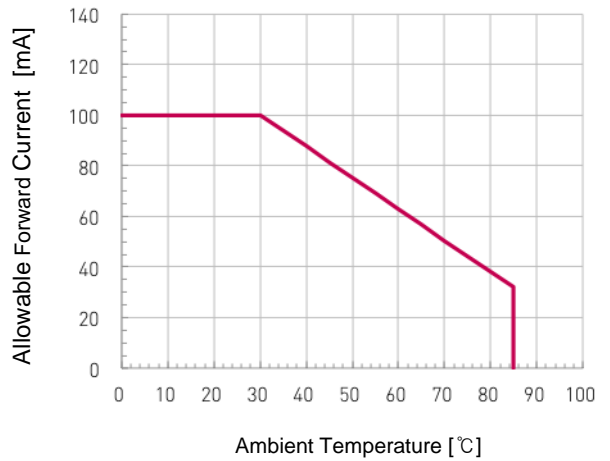

SPECIFICATION

MODEL	LEMWS59Q80LZ10	DOCUMENT No	12(LIR)-H-09
REG.DATE	12.3.29	REV.No	1.0
REG.DATE	12.3.29	PAGE	10 / 20

8. Reliability Test Items and Conditions

8-1. The Reliability criteria of SMD LED

Item	Symbol	Test Condition	Limit	
			Min	Max
Forward Voltage	VF	IF = 65mA	-	U.S.L. × 1.1
Luminous Flux	Φ_V	IF = 65mA	S × 0.7	-

*U.S.L : Upper Spec Limit, *L.S.L : Lower Spec Limit *S : Initial Value

※ The Reliability criteria of ESD Test is judged by VF shift ($\pm 0.2V@8mA$) or impedance(Ω) check data.

8-2. Results of Reliability Test

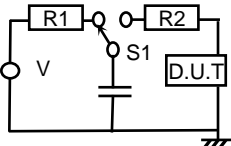
No	Item	Test Condition	Test Hours/ Cycles	Sample No	Ac/Re
1	Steady State Operating Life	Ta=25℃, IF=150mA	1000hr	22 pcs	0 / 1
2	High Temp. Humidity Life I	Ta=60℃, RH=90%, IF=100mA	1000hr	22 pcs	0 / 1
3	Steady State Operating Life of High Temperature	Ta=85℃, IF=100mA	1000hr	22 pcs	0 / 1
4	Steady State Operating Life of Low Temperature	Ta= -30℃, IF=150mA	1000hr	22 pcs	0 / 1
5	High Temp. Storage	Ta=100℃	1000hr	22 pcs	0 / 1
6	Low Temp. Storage	Ta=-40℃	1000hr	22 pcs	0 / 1
7	High Temperature High Humidity Storage	Ta=85℃, RH=85%	1000hr	22 pcs	0 / 1
8	Temperature Cycle	-40℃ (30min) ~ 25℃ (5min) ~ 100℃ (30min) ~ 25℃ (5min)	100cycle	22 pcs	0 / 1
9	Thermal Shock	100℃ (15min) ~ -40℃ (15min)	50cycle	22 pcs	0 / 1
10	Electrostatic Discharge (HBM Mode) Test Voltage 5KV	 <p>R1 :10MΩ, R2:1.5KΩ C:100pF</p>	3times	22 pcs	0 / 1
11	Resistance to Soldering Heat (Reflow Soldering)	Tsld=260℃, 10sec (Pre treatment 30℃, 70%, 168hr)	2 times	22 pcs	0 / 1

SPECIFICATION

MODEL	LEMWS59Q80LZ10	DOCUMENT No	12(LIR)-H-09
REG.DATE	12.3.29	REV.No	1.0
REG.DATE	12.3.29	PAGE	11 / 20

9. Package and Marking of Products

9-1. Taping Outline Dimension

Dimension of Reel

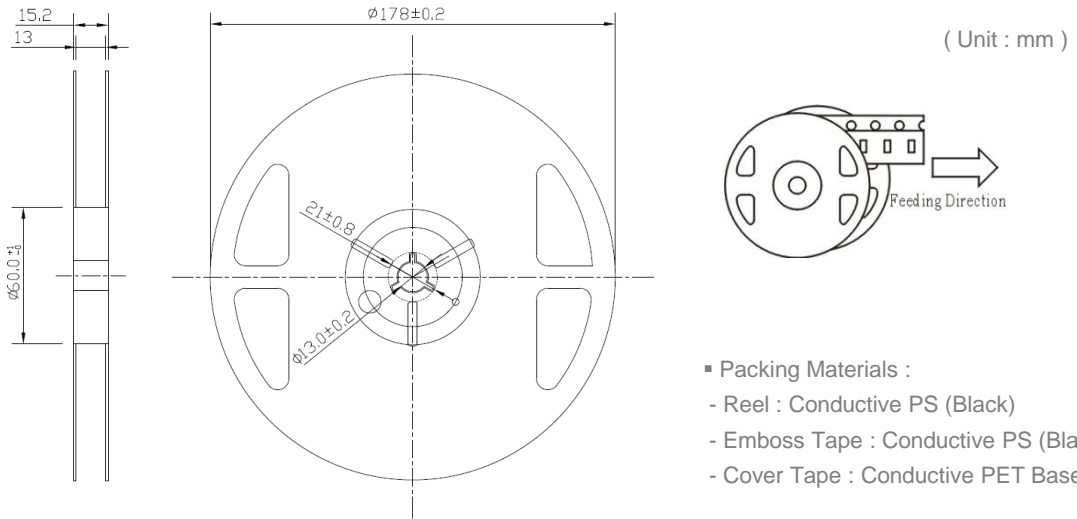

Dimension of Tape

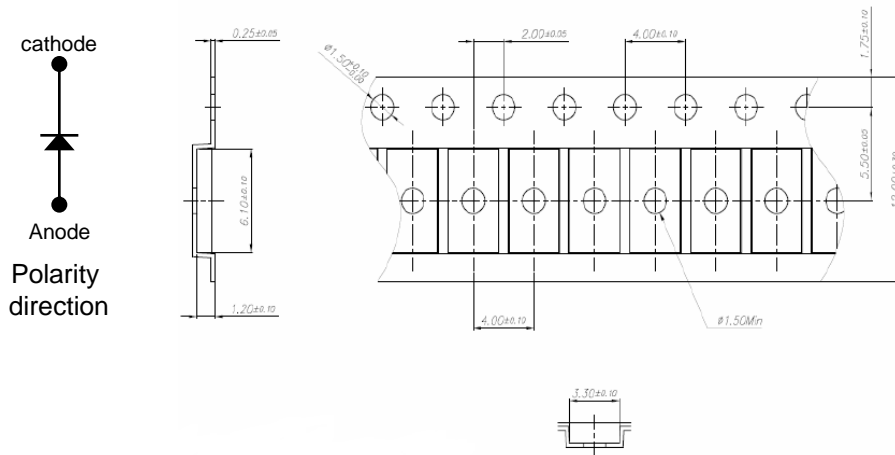

Arrangement of Tape (in case of 3,000ea)



SPECIFICATION

MODEL	LEMWS59Q80LZ10	DOCUMENT No	12(LIR)-H-09
REG.DATE	12.3.29	REV.No	1.0
REG.DATE	12.3.29	PAGE	12 / 20

9-2. Package

Products are packed in one bag of 3,000 pcs (one taping reel) and a label is affixed on each bag specifying Model , Rank, Quantity and Run number.

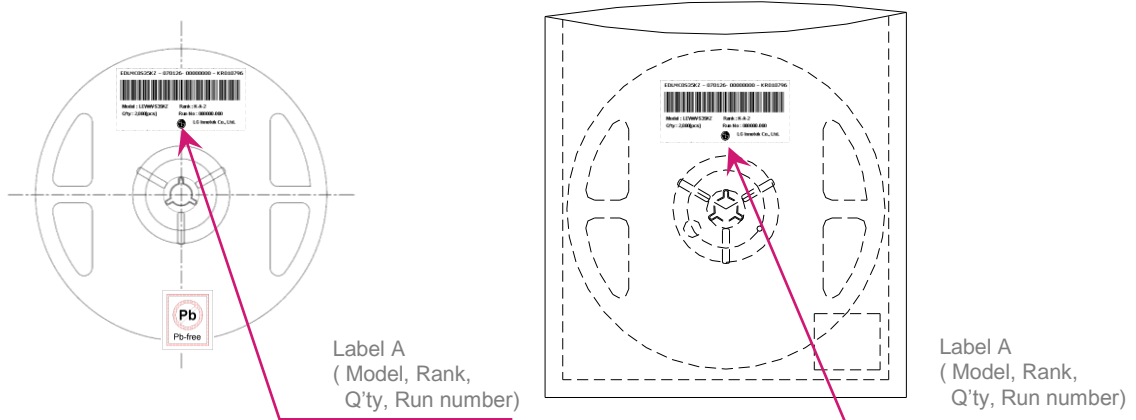

- Package : damp-proof package made of aluminum

※. Label A

Specifying Model Name, Rank, Rank, Quantity and Run number



▪ Run No indication

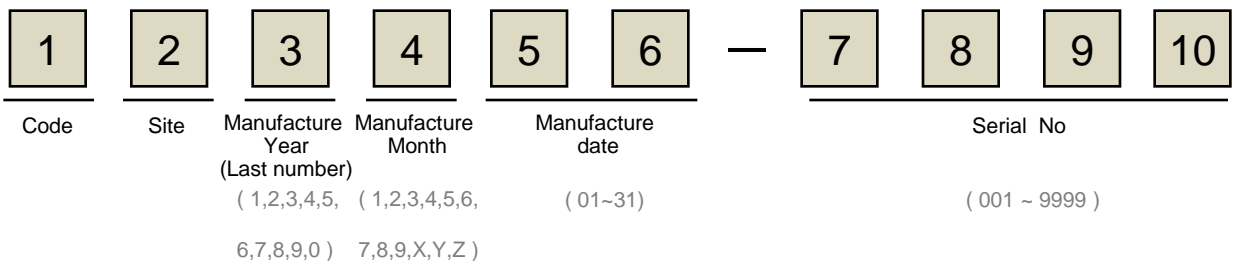

SPECIFICATION

MODEL	LEMWS59Q80LZ10	DOCUMENT No	12(LIR)-H-09
REG.DATE	12.3.29	REV.No	1.0
REG.DATE	12.3.29	PAGE	13 / 20

※ Label C

Specifying Customer, Date, Model Name, Quantity, Customer Part no, Outbox ID, Rank/Rank Q'ty

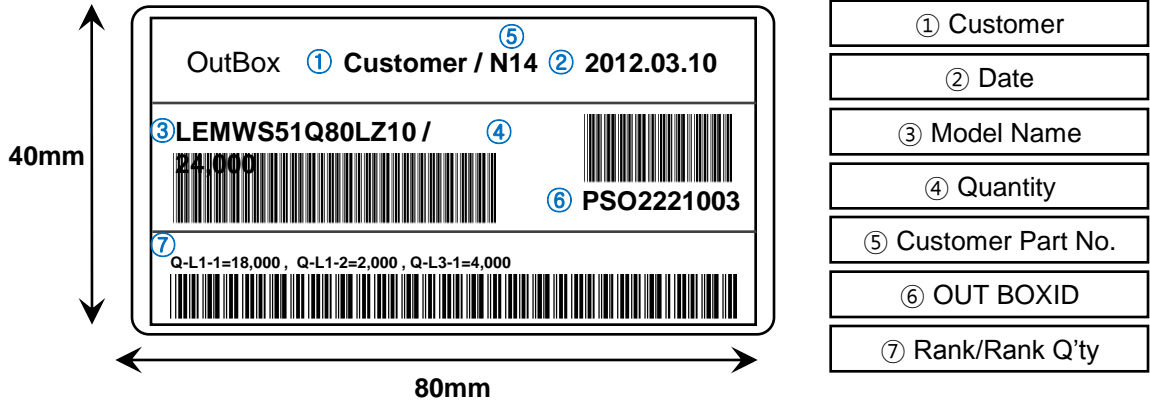

▪ Outbox ID. indication

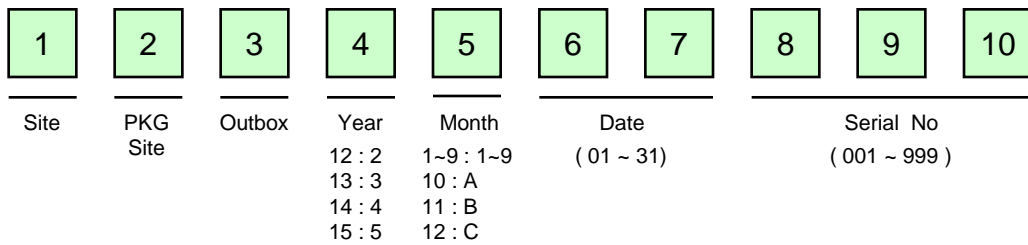

SPECIFICATION

MODEL	LEMWS59Q80LZ10	DOCUMENT No	12(LIR)-H-09
REG.DATE	12.3.29	REV.No	1.0
REG.DATE	12.3.29	PAGE	14 / 20

9-3. Packing Specifications

Reeled products (numbers of products are 3,000 pcs) packed in a seal off aluminum moisture-proof bag along with desiccants (Silica gel).

Four aluminum bags (total maximum number of products are 12,000 pcs) packed in an inner box and Six inner boxes are put into an outer box.

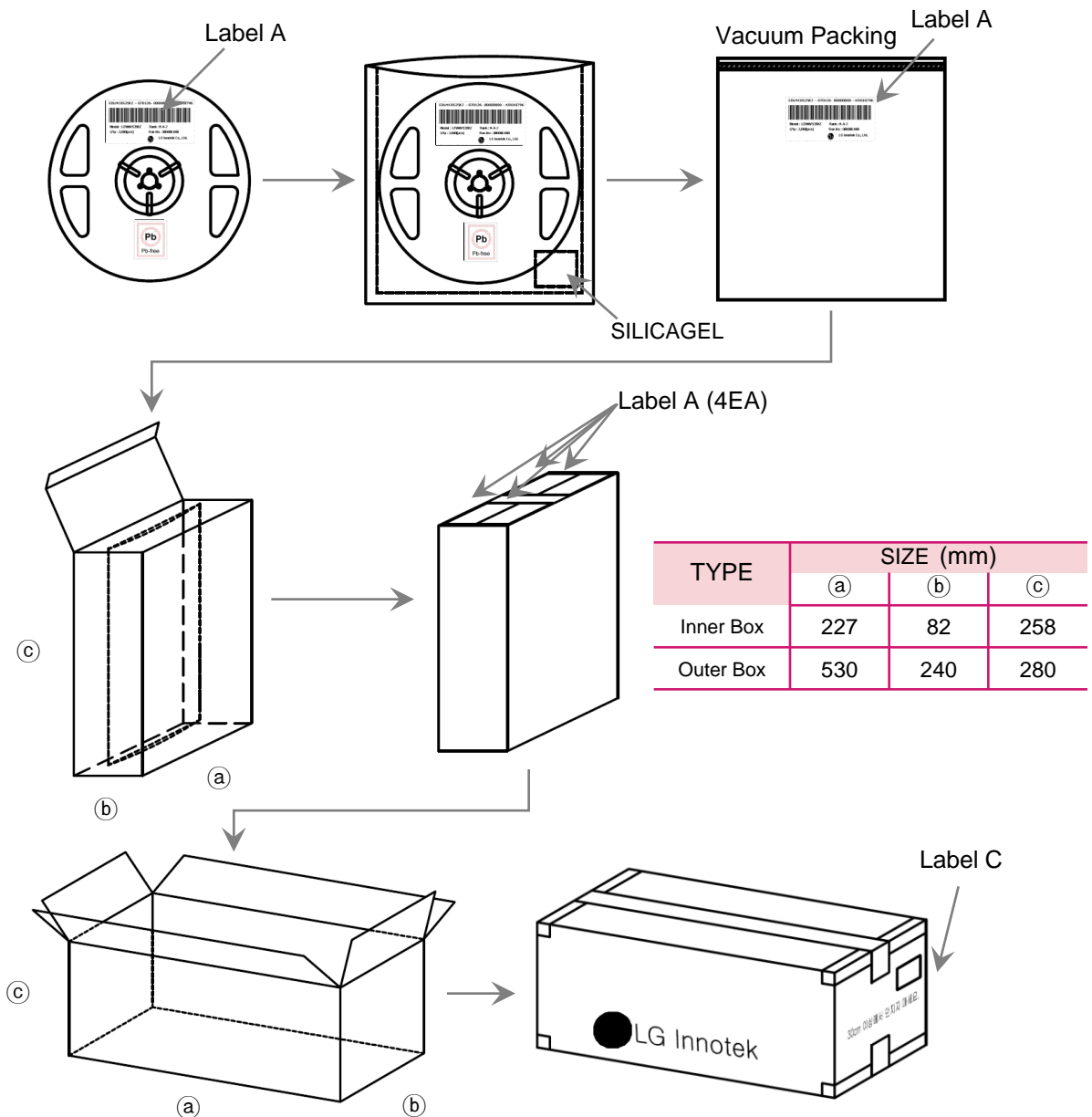

SPECIFICATION

MODEL	LEMWS59Q80LZ10	DOCUMENT No	12(LIR)-H-09
REG.DATE	12.3.29	REV.No	1.0
REG.DATE	12.3.29	PAGE	15 / 20

10. Cautions on use

10-1. Moisture Proof Package

- When moisture is absorbed into the SMD package it may vaporize and expand during soldering.
- There is possibility that this can cause exfoliation of the contacts and damage the optical characteristics of the LEDs.

10-2. For the Storage

Conditions		Temperature	Humidity	Time
Storage	Before Opening Aluminum Bag	≤30°C	≤90%RH	Within 1 Year from Delivery Date
	After Opening Aluminum Bag	≤30°C	≤70%RH	≤168hours
Baking		65±5C	-	≥24hours

Before opening the package

- Proper temperature and RH conditions for storage are : 5 °C ~35 °C, less than 60% RH
- Do not open Moisture-Proof bag before the products are ready to use.

After opening the package

- Proper temperature and RH conditions for storage are : 5 °C ~35 °C, less than 60% RH
- The LEDs should be soldered within 168 hours (7days) after opening the package.
- If unused LEDs remain, they should be stored in a moisture-proof bag with a absorbent Material. (ex. silica gel)
- If the Moisture absorbent material (ex. silica gel) loses its color or the LEDs have exceeded the storage time, baking treatment should be performed using the following condition.
Conditions for baking : 60±5°C, 20% RH and 24 hours maximum.

10-3. For the Usage

- LED PKG should not be used in directly exposed environment containing hazardous substances (ex. Sulfur, Cl)
- The LEDs has silver plated metal parts. The silver plating become tarnished when being exposed to an environment which contains corrosive gases.
- After assembly and during use, silver plating can be affected by the corrosive gases emitted by components and materials in close proximity of the LEDs within an end product, and the gases entering into the product from the external atmosphere.
- Do not expose the LEDs to corrosive atmosphere during storage and using.
- Avoid rapid transitions in ambient temperature, especially in high humidity environments where condensation can occur.
- In designed a circuit, the current through each LED must not exceed the absolute maximum rating

SPECIFICATION

MODEL	LEMWS59Q80LZ10	DOCUMENT No	12(LIR)-H-09
REG.DATE	12.3.29	REV.No	1.0
REG.DATE	12.3.29	PAGE	16 / 20

10-4. Cleaning

- Please avoid using a brush for cleaning and do not wash the product in organic solvents such as acetone, Organic solvent (TCE, etc..) will damage the resin of the LEDs.
- It is recommended the IPA be used as a solvent for cleaning the LEDs. Please refer to following solvents and conditions.
Clearing Condition: Solvent : IPA, 25℃ max × 60 sec. max
- Do not clean the LEDs by the ultrasonic, When it is absolutely necessary, the influence of ultrasonic cleaning on the LEDs depends on factors such as ultrasonic power and the assembled condition.
- Before cleaning, a pre-test should be done to confirm whether any damage to the LEDs will occur.

10-5. Heat Generation

- Thermal design of the end product is of paramount importance.
- Please consider the heat generation of the LED when making the system design.
- The coefficient of temperature increase per input electric power is affected by the thermal resistance of the circuit board and density of LED placement on the board as well as other component.
- It necessary to avoid intense heat generation and operate within the maximum ratings given in the specification.

10-6. Static Electricity

- If over-voltage, which exceeds the absolute maximum rating, is applied to the LEDs, it will damage the LEDs and result in destruction. Since the LEDs are sensitive to the static electricity and surge, it is strongly recommended to use a wristband or anti-electrostatic glove when handling the LEDs and all devices, equipment and machinery must be properly grounded.
- It is recommended that precautions be taken against surge voltage to the equipment the mounts the LEDs.
- Damaged LEDs will show some unusual characteristics such as the leak current remarkably increases, the turn-on voltage becomes lower, or the LEDs do not light at the low current.
- When examining the final product, it is recommended to check whether the assembled LEDs are damaged by static electricity or not. Static-damaged LEDs can easily be found by light-on test or the V_F test at a low current.

SPECIFICATION

MODEL	LEMWS59Q80LZ10	DOCUMENT No	12(LIR)-H-09
REG.DATE	12.3.29	REV.No	1.0
REG.DATE	12.3.29	PAGE	17 / 20

10-7. Recommended Circuit

- In designed a circuit, the current through each LED must not exceed the absolute maximum rating specified for each LED.
- In general, the LEDs have a variation of forward voltage. Using LEDs with different forward voltages in a circuit with on resistor for the complete circuit causes different forward currents for each LED. This may lead to a variation in brightness. In the worst case, some LED may be subjected to the stresses in excesses of the absolute maximum rating. To avoid brightness variation of LEDs, the use of matrix circuit with one resistor for each LED is recommended.

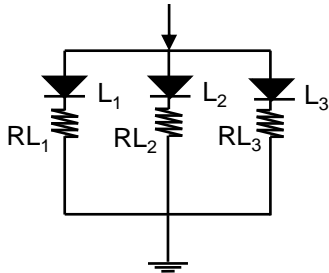

Pic.1 Recommended Circuit in parallel mode
: Separate resistor must be used in each LED

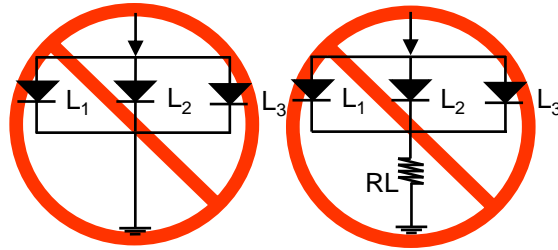

Pic.2. Abnormal Circuit
The Current through the LEDs may vary due to the variation in forward voltage (V_f) of the LEDs.

- LED should be operated in forward bias. A driving Circuit must be designed so that the LED is not subjected to either forward or reverse voltage while it is off. In particular, if a reverse voltage is continuously applied to the LED, such operation can cause migration resulting in LED damage.
- If reverse voltage is applied to the LEDs, it will damage the Zener diode and LEDs and result in destruction.

10-8. Application limits of LED Driver IC controller

- GaN based LED is relatively weak to electrical damage (such as static electricity and over current stress). Forward leakage of LED occurred by such damage in the forward low current region may result in turn-on-delay of Lighting Module, which is dependent on a specific function of driver IC.
- For reasons mentioned above, minimum current level (source start-up current) of LED driver IC must be more than 0.3 mA. LGIT cannot make a guarantee on the LED using in Driver IC with start up current level of < 0.3 mA.
- When parallel circuit LED driver IC is applied in Lighting Module, Hot spot may occur in low current operation region (dimming mode) by difference of LED voltage in low current region. So, driver IC with Individual LED controller is recommended.

SPECIFICATION

MODEL	LEMWS59Q80LZ10	DOCUMENT No	12(LIR)-H-09
REG.DATE	12.3.29	REV.No	1.0
REG.DATE	12.3.29	PAGE	18 / 20

10-9. Soldering Conditions.

- The LEDs can be soldered in place using the reflow soldering method.
- LG Innotek cannot make a guarantee on the LEDs after they have been assembled using dip soldering method.
- Recommended soldering conditions
- Pb Solder

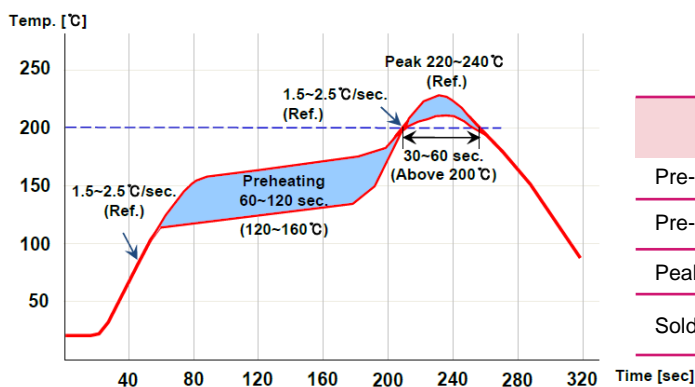

Lead Free Solder	
Pre-heat	120~160°C
Pre-heat time	120 sec.
Peak-Temperature	220~240°C
Soldering time Condition	30~60 sec.

- Pb-free Solder

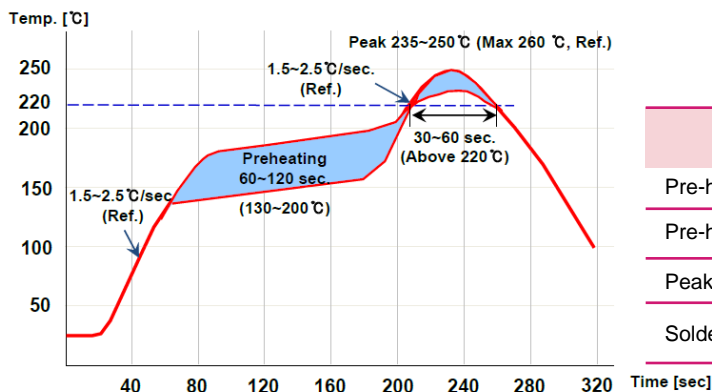

Lead Free Solder	
Pre-heat	130~200°C
Pre-heat time	120 sec.
Peak-Temperature	235~250°C
Soldering time Condition	30~60 sec.

- Although the recommended soldering conditions are specified in the above diagram, reflow or hand soldering at the lowest possible temperature is desirable for the LEDs.
- A rapid-rate process is not recommended for cooling the LEDs down from the peak temperature.
- Occasionally there is a brightness decrease caused by the influence of heat of ambient atmosphere during air reflow. It is recommended that the customer use the nitrogen reflow method.
- The encapsulated material of the LEDs is silicone, Therefore the LEDs have a soft surface on the top of the package. The pressure to the surface will be influence to the reliability of the LEDs. Precautions should be taken to avoid the strong pressure on the encapsulated part. So When using the chip mounter, the picking up nozzle that does not affect the silicone resin should be used.
- Reflow soldering should not be done more than two times.

SPECIFICATION

MODEL	LEMWS59Q80LZ10	DOCUMENT No	12(LIR)-H-09
REG.DATE	12.3.29	REV.No	1.0
REG.DATE	12.3.29	PAGE	19 / 20

10-10. Soldering Iron

- Basic spec is ≤ 5 sec when 260°C .
- If temperature is higher, time shorter ($+10^{\circ}\text{C} \rightarrow -1$ sec).
- Power dissipation of Iron should be smaller than 15W, and temperature should be controllable. Surface temperature of the device should be under 230°C .

10-11. Repair

- Repairing should not be done after the LEDs have been soldered.
- When repairing is unavoidable, a double-head soldering iron should be used.
- It should be confirmed beforehand whether the characteristics of the LEDs will or will not be damaged by repairing.
- When Soldering, do not put stress on the LEDs during heating customer must finish rework within 5sec. under 245°C .
- The head of Iron can not touch copper foil.
- Twin-head type is preferred.

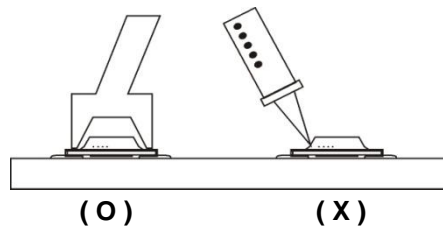

10-12. Safety Guideline for Human Eyes.

- Users should be cautioned not to stare at the light of this LED product.
- Great care should be taken when viewing directly the LED driven at high current or the LED with optical instruments, which may greatly increase the hazard to your eyes.

SPECIFICATION

MODEL	LEMWS59Q80LZ10	DOCUMENT No	12(LIR)-H-09
REG.DATE	12.3.29	REV.No	1.0
REG.DATE	12.3.29	PAGE	20 / 20

11. Others

- LG Innotek will not be held responsible for any damage to the user that may result from accidents or any other reasons during operation of the user's unit if use to exceed the absolute maximum ratings, or not keep the matters that demand special attention.
- The LEDs described in this brochure are intended to be used for ordinary electronic equipment.
- Consult LG Innotek, sales staff in advance for information on the applications in which exceptional quality and reliability are required, particularly when the failure or malfunction of the LEDs, may directly jeopardize life or health.
- The customer shall not reverse engineer by disassembling or analysis of the LEDs without having prior written consent from LG Innotek. When defective LEDs are found, The customer shall inform LG Innotek disassembling or analysis.
- The formal specifications must be exchanged and signed by both parties before large volume purchase begins.
- The appearance and specification of the product may be modified for improvement without notice
- **Manual Handling**
Use tweezers to grab base of LED PKG. Do not touch the lens with the tweezers.

