

VIEW-B

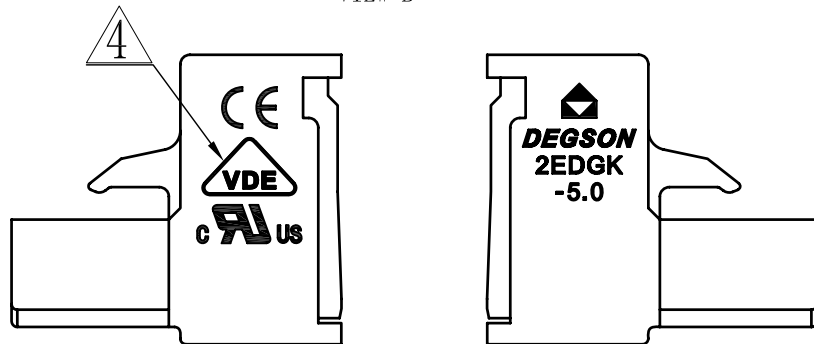

5	2EDG "—"Screws-M2.5	S000001370 (H)	XX	Steel	Cr ³⁺ Zn
4	DG128-Brass cage	X000000020 (H)	XX	Brass	Ni plated
3	2EDG-Clamp	1005B00010 (H)	XX	Phosor bronze	Ni plated
2	2EDGK-5.0-Cover	1016C0YXXA (H)	1	PA66	UL94V-0

REVISION RECORD				
REV	ECO	DESCRIPTION	DRFT	DATE
△		Drawing emend	WF	01/05/06*
△		修改UL刻字	CSX	06/18/07*
△		增加VDE、CE认证标志	LJH	01/14/08*

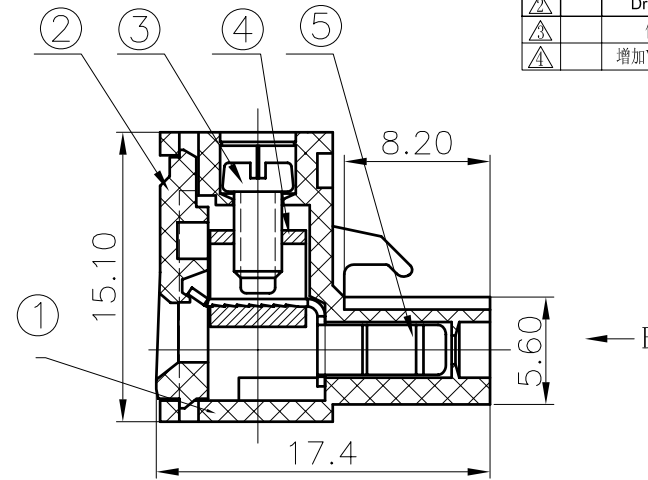

SECTION A-A

Notes:

- Pitch: 5.0mm Poles:2-24p
- Rated voltage/current:UL 300V/15A
VDE 320V/20A
- Insulation resistance: 5000MΩ/1000V
- Withstanding voltage: AC1500V/1min
- Wire range: 28-12AWG 2.5mm²
- Temp. Range: -40° C~+105° C
- Torque: 4.08kgf.cm
- Undimensioned Tolerances:

Pitch range in mm		Nominal dimension range in mm						
	over 6	over 10	over 30	over 60	over 100	over 150	—	
to 6	to 10	to 24	to 30	to 60	to 100	to 150	∩	
±0.10	±0.15	±0.25	±0.2	±0.3	±0.5	±0.7	±1.0 0.05/10	

1	2EDGK-5.0-Housing	1016A0YXXA (H)	1	PA66	UL94V-0												
ITEM	NAME OF PART	NO. OF PART	Q'TY	MATERIAL	NOTES												
<table border="1"> <tr> <td>← MM (INCH) →</td> <td>DFTO Haoyh</td> <td>DATE 04/18/05</td> </tr> <tr> <td>TOLERANCES EXCEPT AS NOTED</td> <td>CHKD</td> <td>DATE</td> </tr> <tr> <td></td> <td>MFO</td> <td>DATE</td> </tr> <tr> <td></td> <td>APPVL</td> <td>DATE</td> </tr> </table>		← MM (INCH) →	DFTO Haoyh	DATE 04/18/05	TOLERANCES EXCEPT AS NOTED	CHKD	DATE		MFO	DATE		APPVL	DATE	宁波高正电子有限公司 DEGSON ELECTRONICS CO., LTD			
← MM (INCH) →	DFTO Haoyh	DATE 04/18/05															
TOLERANCES EXCEPT AS NOTED	CHKD	DATE															
	MFO	DATE															
	APPVL	DATE															
<table border="1"> <tr> <td>MM</td> <td>±</td> </tr> <tr> <td>.0 ±</td> <td>±</td> </tr> <tr> <td>.00 ±</td> <td>±</td> </tr> <tr> <td>.000 ±</td> <td>±</td> </tr> </table>		MM	±	.0 ±	±	.00 ±	±	.000 ±	±	NAME 2EDGK-5.0-XXP-1Y-00A(H)							
MM	±																
.0 ±	±																
.00 ±	±																
.000 ±	±																
ANGLES ± 1°		G.E :		DRAWING NO. 2EDGK-5.0-E10													
		FINISH :		SIZE A3													
THIRD ANGLE PROJECTION		SCALE : 1:1		REV T4 01/14/08*													
DO NOT SCALE DRAWING				SHEET 1 OF 1													