

EC28A 28mm Size Ring Type

A low-profile unit with 4mm height and good operation feel

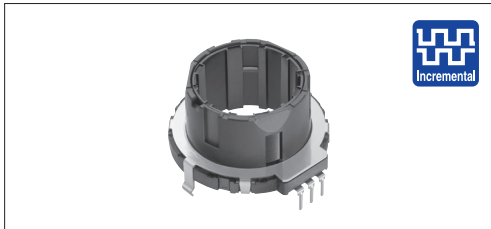

Encoders



Typical Specifications

Items	Specifications
Rating	10mA 5V DC
Operating life	50,000 cycles
Operating temperature range	-40°C to +85°C

Product Line

Actuator length (mm)	Detent torque (mN·m)	Number of detent	Number of pulse	Minimum order unit (pcs.)		Product No.
				Japan	Export	
15	7±5	30	15	400	800	EC28A1520401
	12±7					EC28A1550401
	20±10					EC28A1560401
	12±7	EC28A1850402				
	20±10	EC28A1870401				

Packing Specifications

Tray

Number of packages (pcs.)		Export package measurements (mm)
1 case /Japan	1 case /export packing	
400	800	366×509×287

Dimensions

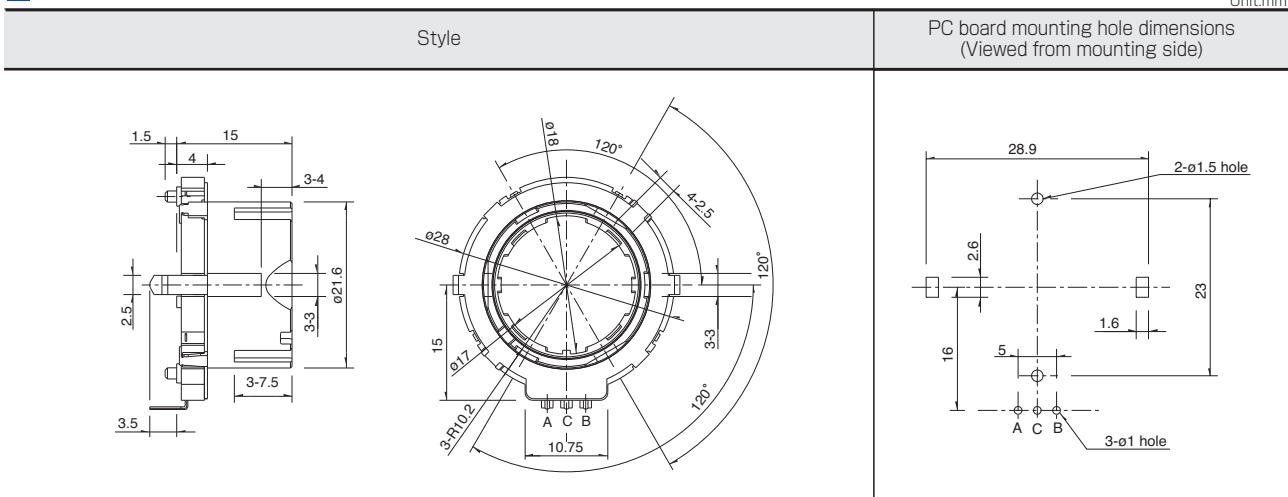



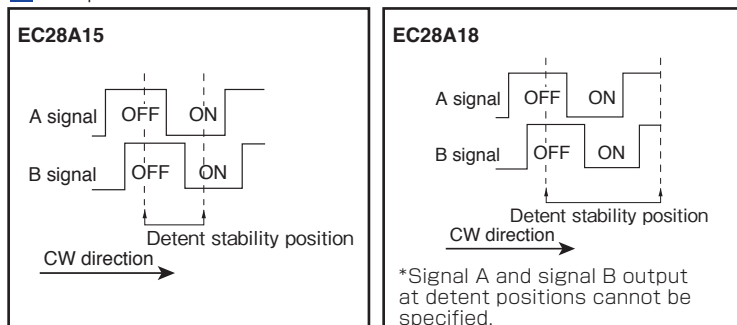



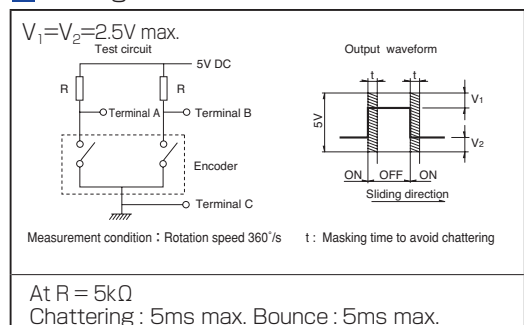





Output Wave



Sliding Noise



Type		Ring type					
		21mm size		28mm size	35mm size		
Series		EC21A	EC21C	EC28A	EC35A	EC35AH	EC35B
Photo							
Output		Incremental (Two phase A and B)				Incremental (Three phase A, B and C)	Incremental (Two phase A and B) / Self-return switch
Shaft types		Ring type					
Number of pulse / Number of detent		9/18 15/30	15/30	15/30 18/18	15/30	6×ABC/18 10×ABC/30	15/30
Dimensions (mm)	W	21.6	22	28	35	35	
	D		21.6	29			
	H	4		4.5		12.1	
Operating temperature range		-40°C to +85°C					
Operating life		50,000 cycles					30,000 cycles
Automotive use		●	●	●	●	●	●
Life cycle (availability)							
Electrical performance	Rating	10mA 5V DC					
	Max./min. operating current (Resistive load)	10mA / 1mA					
	Insulation resistance	100MΩ min. 250V DC					
	Voltage proof	300V AC for 1minute or 360V AC for 2s	300V AC for 1minute or 360V AC for 1s	300V AC for 1minute or 360V AC for 2s			300V AC for 1minute or 360V AC for 1s
Mechanical performance	Detent torque	7±5mN·m 16±7mN·m	17±8mN·m (Initial) 12±7mN·m (After reflow)	7±5mN·m 12±7mN·m 20±10mN·m	18±7mN·m	12±5mN·m 18±7mN·m 30±15mN·m	20±10mN·m
	Push-pull strength	Push	100N				
		Pull	100N				
Shaft configuration		Ring type					
Terminal type		Insertion					
Switch Specifications	Switch type	—	—	—	—	—	Self-return switch
	Contact arrangement	—	—	—	—	—	Single pole and double throw
	Travel (mm)	—	—	—	—	—	2.8±0.5
	Operating force (N)	—	—	—	—	—	3.8±1.5
	Switch ON position	—	—	—	—	—	15°±5°
	Rotational torque	—	—	—	—	—	40±25mN·m
	Rating	—	—	—	—	—	10mA 5V DC
	Contact resistance	—	—	—	—	—	200mΩ max.
	Operating life	—	—	—	—	—	15,000 cycles
Page	296		298	299	300	302	

Encoders Soldering Conditions 307
 Encoders Cautions 308

Note

● Indicates applicability to all products in the series.

Reference for Manual Soldering

Series	Tip temperature	Soldering time	No. of solders
EC05E, EC09E, EC10E, EC111, EC11B, EC11E, EC11G, EC11K, EC12D, EC12E, EC18A, EC21A, EC28A, EC35A, EC35AH, EC35B, EC40A, EC45A, EC50A, EC60B, EM11B, EM20B, EC21C	350°C max.	3s max.	1 time
EC11J	350±10°C	3 ⁺¹ ₀ s	2 time

Reference for Dip Soldering

Series	Preheating		Dip soldering		No. of solders
	Soldering surface temperature	Heating time	Soldering temperature	Soldering time	
EC09E, EC11B, EC111, EC11E, EC11G, EC11K, EC18A, EC21A, EC28A, EC35A, EC35AH, EC35B, EC50A, EC60B	100°C max.	2 min. max.	260±5°C	5±1s	2 time max.
EC10E, EC12D, EC12E, EM11B	100°C max.	1 min. max.	260±5°C	3±1s	2 time max.
EC40A	110°C max.	1 min. max.	260°C max.	10s max.	1 time
EC45A	100°C max.	2 min. max.	260°C max.	5s max.	2 time max.
EM20B	80°C max.	1 min. max.	260°C max.	3s max.	2 time max.

Example of Reflow Soldering Condition

Temperature profile

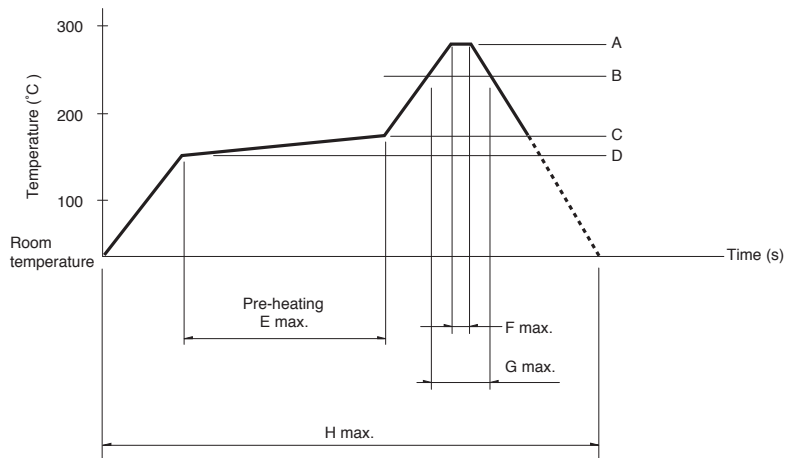

Series	A	B	C	D	E	F	G	H	No. of reflows
EC11J	260°C	230°C	180°C	150°C	2 min. max.	3s	40s	4 min. max.	2 time max.
EC05E	250°C min.	230°C min.	180°C	150°C	60s to 120s	—	30s to 40s	—	2 time max.
EC21C	230°C to 245°C	220°C	200°C	150°C	60s to 120s	—	25s to 60s	300 max.	1 time max.

注記

- When using an infrared reflow oven, solder may sometimes not be applied. Be sure to use a hot air reflow oven or a type that uses infrared rays in combination with hot air.
- The temperatures given above are the maximum temperatures at the terminals of the encoder when employing a hot air reflow method. The temperature of the PC board and the surface temperature of the encoder may vary greatly depending on the PC board material, its size and thickness. Ensure that the surface temperature of the encoder does not rise to 250°C or greater.
- Conditions vary to some extent depending on the type of reflow bath used. Be sure to give due consideration to this prior to use.