

μA776 Multi-Purpose Programmable Operational Amplifier

Linear Division Operational Amplifiers

Description

The μA776 Programmable Operational Amplifier is constructed using the Fairchild Planar Epitaxial process. High input impedance, low supply currents, and low input noise over a wide range of operating supply voltages coupled with programmable electrical characteristics result in an extremely versatile amplifier for use in high accuracy, low power consumption analog applications. Input noise voltage and current, power consumption, and input current can be optimized by a single resistor or current source that sets the chip quiescent current for nano watt power consumption or for characteristics similar to the μA741. Internal frequency compensation, absence of latch up, high slew rate and short circuit current protection assure ease of use in long time integrators, active filters, and sample and hold circuits.

- **Micropower Consumption**
- **± 1.2 V To ± 18 V Operation**
- **No Frequency Compensation Required**
- **Low Input Bias Currents**
- **Wide Programming Range**
- **High Slew Rate**
- **Low Noise**
- **Short Circuit Protection**
- **Offset Null Capability**
- **No Latch Up**

Absolute Maximum Ratings

Storage Temperature Range

Metal Can	-65°C to +175°C
Molded DIP	-65°C to +150°C

Operating Temperature Range

Extended (μA776M)	-55°C to +125°C
Commercial (μA776C)	0°C to +70°C

Lead Temperature

Metal Can (soldering, 60 s)	300°C
Molded DIP (soldering, 10 s)	265°C

Internal Power Dissipation^{1, 2}

8L-Metal Can	1.00 W
8L-Molded DIP	0.93 W

Supply Voltage

± 18 V

Differential Input Voltage

± 30 V

Input Voltage³

± 15 V

Voltage Between Offset Null and V-

± 0.5 V

Output Short Circuit Duration⁴

Indefinite

I_{SET} (Maximum Current at I_{SET})

500 μA

V_{SET} (Maximum Voltage to

(V+ -2.0 V)

Ground at I_{SET}) ≤ V_{SET} ≤ V+

Notes

1. T_{J Max} = 150°C for the Molded DIP, and 175°C for the Metal Can.
2. Ratings apply to ambient temperature at 25°C. Above this temperature, derate the 8L-Metal Can at 6.7 mW/°C, and the 8L-Molded DIP at 7.5 mW/°C.

Connection Diagram 8-Lead Metal Package (Top View)

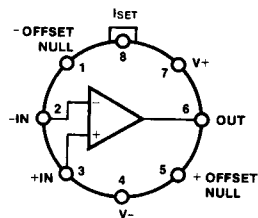

CD00631F

Lead 4 connected to case.

Order Information

Device Code	Package Code	Package Description
μA776HM	5W	Metal
μA776HC	5W	Metal

Connection Diagram 8-Lead DIP (Top View)

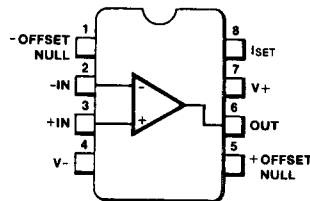

CD00641F

Order Information

Device Code	Package Code	Package Description
μA776TC	9T	Molded DIP

3. For supply voltages less than ± 15 V, the absolute maximum input voltage is equal to the supply voltage.
4. Short Circuit may be to ground or either supply. Rating applies to 125°C case temperature or 75°C ambient temperature for I_{SET} ≤ 30 μA.

Equivalent Circuit

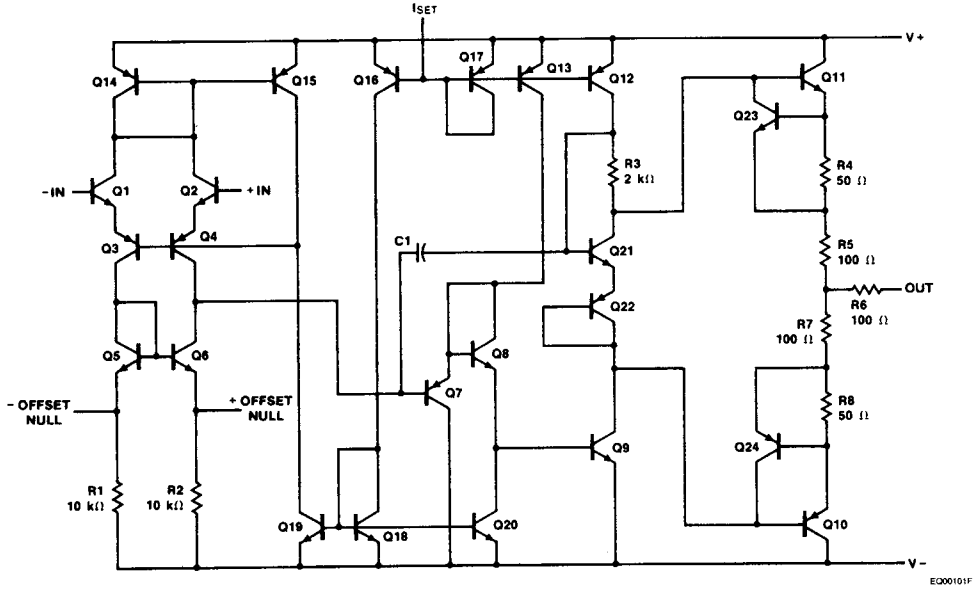

7

μA776

μA776

Electrical Characteristics $T_A = 25^\circ\text{C}$, $V_{CC} = \pm 15\text{ V}$, unless otherwise specified.

Symbol	Characteristic	Condition	$I_{SET} = 1.5\mu\text{A}$			$I_{SET} = 15\mu\text{A}$			Unit
			Min	Typ	Max	Min	Typ	Max	
V_{IO}	Input Offset Voltage	$R_S \leq 10\text{ k}\Omega$		2.0	5.0		2.0	5.0	mV
$V_{IO\text{ adj}}$	Input Offset Voltage Adjustment Range			9.0			18		mV
I_{IO}	Input Offset Current			0.7	3.0		2.0	15	nA
I_{IB}	Input Bias Current			2.0	7.5		15	50	nA
Z_I	Input Impedance			50			5.0		M Ω
I_{CC}	Supply Current			20	25		160	180	μA
P_c	Power Consumption				0.75			5.4	mW
I_{OS}	Output Short Circuit Current			3.0			12		mA
A_{VS}	Large Signal Voltage Gain	$V_O = \pm 10\text{ V}$, $R_L \geq 75\text{ k}\Omega$	200	400					V/mV
		$V_O = \pm 10\text{ V}$, $R_L \geq 5.0\text{ k}\Omega$				100	400		
V_{OP}	Output Voltage Swing	$R_L = 75\text{ k}\Omega$	± 12	± 14					V
		$R_L = 5.0\text{ k}\Omega$				± 10	± 13		
TR	Transient Response	Rise time	$V_I = 20\text{ mV}$, $R_L = 5.0\text{ k}\Omega$, $C_L = 100\text{ pF}$, $A_V = 1.0$		1.6		0.35		μs
		Overshoot			0		10		%
SR	Slew Rate	$R_L = 5.0\text{ k}\Omega$, $A_V = 1.0$		0.1			0.8		V/ μs

The following specifications apply $-55^\circ\text{C} \leq T_A \leq +125^\circ\text{C}$

V_{IO}	Input Offset Voltage	$R_S \leq 10\text{ k}\Omega$			6.0			6.0	mV
I_{IO}	Input Offset Current	$T_A = +125^\circ\text{C}$			5.0			15	nA
		$T_A = -55^\circ\text{C}$			10			40	
I_{IB}	Input Bias Current	$T_A = +125^\circ\text{C}$			7.5			50	nA
		$T_A = -55^\circ\text{C}$			20			120	
I_{CC}	Supply Current				30			200	μA
P_c	Power Consumption				0.9			6.0	mW
CMR	Common Mode Rejection	$R_S \leq 10\text{ k}\Omega$	70	90		70	90		dB
V_{IR}	Input Voltage Range		± 10			± 10			V
PSRR	Power Supply Rejection Ratio	$R_S \leq 10\text{ k}\Omega$		25	150		25	150	$\mu\text{V/V}$
A_{VS}	Large Signal Voltage Gain	$V_O = \pm 10\text{ V}$, $R_L \geq 75\text{ k}\Omega$	100			75			V/mV
V_{OP}	Output Voltage Swing	$R_L = 75\text{ k}\Omega$	± 10			± 10			V

μA776

Electrical Characteristics $T_A = 25^\circ\text{C}$, $V_{CC} = \pm 3.0\text{ V}$, unless otherwise specified.

Symbol	Characteristic	Condition	$I_{SET} = 1.5\mu\text{A}$			$I_{SET} = 15\mu\text{A}$			Unit
			Min	Typ	Max	Min	Typ	Max	
V_{IO}	Input Offset Voltage	$R_S \leq 10\text{ k}\Omega$		2.0	5.0		2.0	5.0	mV
$V_{IO\text{ adj}}$	Input Offset Voltage Adjustment Range			9.0			18		mV
I_{IO}	Input Offset Current			0.7	3.0		2.0	15	nA
I_{IB}	Input Bias Current			2.0	7.5		15	50	nA
Z_I	Input Impedance			50			5.0		MΩ
I_{CC}	Supply Current			13	20		130	160	μA
P_c	Power Consumption			78	120		780	960	μW
I_{OS}	Output Short Circuit Current			3.0			5.0		mA
A_{VS}	Large Signal Voltage Gain	$V_O = \pm 1.0\text{ V}$, $R_L \geq 75\text{ k}\Omega$	50	200					V/mV
		$V_O = \pm 1.0\text{ V}$, $R_L \geq 5.0\text{ k}\Omega$				50	200		
TR	Transient Response	Rise time	$V_I = 20\text{ mV}$, $R_L = 5.0\text{ k}\Omega$, $C_L = 100\text{ pF}$, $A_V = 1.0$	3.0			0.6		μs
		Overshoot		0			5		%
SR	Slew Rate	$R_L = 5.0\text{ k}\Omega$, $A_V = 1.0$		0.03			0.35		V/μs

7

The following specifications apply $-55^\circ\text{C} \leq T_A \leq +125^\circ\text{C}$

V_{IO}	Input Offset Voltage	$R_S \leq 10\text{ k}\Omega$			6.0			6.0	mV
I_{IO}	Input Offset Current	$T_A = +125^\circ\text{C}$			5.0			15	nA
		$T_A = -55^\circ\text{C}$			10			40	nA
I_{IB}	Input Bias Current	$T_A = +125^\circ\text{C}$			7.5			50	nA
		$T_A = -55^\circ\text{C}$			20			120	nA
I_{CC}	Supply Current				25			180	μA
P_c	Power Consumption				150			1080	μW
CMR	Common Mode Rejection	$R_S \leq 10\text{ k}\Omega$	70	86		70	86		dB
V_{IR}	Input Voltage Range		± 1.0			± 1.0			V
PSRR	Power Supply Rejection Ratio	$R_S \leq 10\text{ k}\Omega$		25	150		25	150	μV/V
A_{VS}	Large Signal Voltage Gain	$V_O = \pm 1.0\text{ V}$, $R_L \geq 75\text{ k}\Omega$	25						V/mV
		$V_O = \pm 1.0\text{ V}$, $R_L \geq 5.0\text{ k}\Omega$				25			
V_{OP}	Output Voltage Swing	$R_L = 75\text{ k}\Omega$	± 2.0	± 2.4					V
		$R_L = 5.0\text{ k}\Omega$				± 1.9	± 2.1		

μA776

μA776C

Electrical Characteristics $T_A = 25^\circ\text{C}$, $V_{CC} = \pm 15\text{ V}$, unless otherwise specified.

Symbol	Characteristic	Condition	$I_{SET} = 1.5\mu\text{A}$			$I_{SET} = 15\mu\text{A}$			Unit
			Min	Typ	Max	Min	Typ	Max	
V_{IO}	Input Offset Voltage	$R_S \leq 10\text{ k}\Omega$		2.0	6.0		2.0	6.0	mV
$V_{IO\text{ adj}}$	Input Offset Voltage Adjustment Range			9.0			18		mV
I_{IO}	Input Offset Current			0.7	6.0		2.0	25	nA
I_{IB}	Input Bias Current			2.0	10		15	50	nA
Z_I	Input Impedance			50			5.0		MΩ
I_{CC}	Supply Current			20	30		160	190	μA
P_c	Power Consumption				0.9			5.7	mW
I_{OS}	Output Short Circuit Current			3.0			12		mA
A_{VS}	Large Signal Voltage Gain	$V_O = \pm 10\text{ V}$, $R_L \geq 75\text{ k}\Omega$	50	400					V/mV
		$V_O = \pm 10\text{ V}$, $R_L \geq 5.0\text{ k}\Omega$				50	400		
V_{OP}	Output Voltage Swing	$R_L = 75\text{ k}\Omega$	± 12	± 14					V
		$R_L = 5.0\text{ k}\Omega$				± 10	± 13		
TR	Transient Response	Rise time	$V_I = 20\text{ mV}$, $R_L \geq 5.0\text{ k}\Omega$, $C_L = 100\text{ pF}$, $A_V = 1.0$		1.6		0.35		μs
		Overshoot			0		10		%
SR	Slew Rate	$R_L = 5.0\text{ k}\Omega$, $A_V = 1.0$		0.1			0.8		V/μs

The following specifications apply $0^\circ\text{C} \leq T_A \leq +70^\circ\text{C}$

V_{IO}	Input Offset Voltage	$R_S \leq 10\text{ k}\Omega$			7.5			7.5	mV
I_{IO}	Input Offset Current	$T_A = 70^\circ\text{C}$			6.0			25	nA
		$T_A = 0^\circ\text{C}$			10			40	
I_{IB}	Input Bias Current	$T_A = 70^\circ\text{C}$			10			50	nA
		$T_A = 0^\circ\text{C}$			20			100	
I_{CC}	Supply Current				35			200	μA
P_c	Power Consumption				1.05			6.0	mW
CMR	Common Mode Rejection	$R_S \leq 10\text{ k}\Omega$	70	90		70	90		dB
V_{IR}	Input Voltage Range		± 10			± 10			V
PSRR	Power Supply Rejection Ratio	$R_S \leq 10\text{ k}\Omega$		25	200		25	200	μV/V
A_{VS}	Large Signal Voltage Gain	$V_O = \pm 10\text{ V}$, $R_L \geq 75\text{ k}\Omega$	50			50			V/mV
V_{OP}	Output Voltage Swing	$R_L = 75\text{ k}\Omega$	± 10			± 10			V

μA776

μA776C

Electrical Characteristics $T_A = 25^\circ\text{C}$, $V_{CC} = \pm 3.0\text{ V}$, unless otherwise specified.

Symbol	Characteristic	Condition	$I_{SET} = 1.5\mu\text{A}$			$I_{SET} = 15\mu\text{A}$			Unit
			Min	Typ	Max	Min	Typ	Max	
V_{IO}	Input Offset Voltage	$R_S \leq 10\text{ k}\Omega$		2.0	6.0		2.0	6.0	mV
$V_{IO\text{ adj}}$	Input Offset Voltage Adjustment Range			9.0			18		mV
I_{IO}	Input Offset Current			0.7	6.0		2.0	25	nA
I_{IB}	Input Bias Current			2.0	10		15	50	nA
Z_I	Input Impedance			50			5.0		MΩ
I_{CC}	Supply Current			13	20		130	170	μA
P_C	Power Consumption			78	120		780	1020	μW
I_{OS}	Output Short Circuit Current			3.0			5.0		mA
A_{VS}	Large Signal Voltage Gain	$V_O = \pm 1.0\text{ V}$, $R_L \geq 75\text{ k}\Omega$	25	200					V/mV
		$V_O = \pm 1.0\text{ V}$, $R_L \geq 5.0\text{ k}\Omega$				25	200		
TR	Transient Response	Rise time		3.0			0.6		μs
		Overshoot		0			5		%
SR	Slew Rate	$R_L = 5.0\text{ k}\Omega$, $A_V = 1.0$		0.03			0.35		V/μs

7

The following specifications apply $0^\circ\text{C} \leq T_A \leq +70^\circ\text{C}$

V_{IO}	Input Offset Voltage	$R_S \leq 10\text{ k}\Omega$			7.5			7.5	mV
I_{IO}	Input Offset Current	$T_A = 70^\circ\text{C}$			6.0			25	nA
		$T_A = 0^\circ\text{C}$			10			40	
I_{IB}	Input Bias Current	$T_A = 70^\circ\text{C}$			10			50	nA
		$T_A = 0^\circ\text{C}$			20			100	
I_{CC}	Supply Current				25			180	μA
P_C	Power Consumption				150			1080	μW
CMR	Common Mode Rejection	$R_S \leq 10\text{ k}\Omega$	70	86		70	86		dB
V_{IR}	Input Voltage Range		± 1.0			± 1.0			V
PSRR	Power Supply Rejection Ratio	$R_S \leq 10\text{ k}\Omega$		25	200		25	200	μV/V
A_{VS}	Large Signal Voltage Gain	$V_O = \pm 1.0\text{ V}$, $R_L \geq 75\text{ k}\Omega$	25						V/mV
		$V_O = \pm 1.0\text{ V}$, $R_L \geq 5.0\text{ k}\Omega$				25			
V_{OP}	Output Voltage Swing	$R_L = 75\text{ k}\Omega$	± 2.0	± 2.4					V
		$R_L = 5.0\text{ k}\Omega$				± 2.0	± 2.1		

Typical Performance Curves for μA776 and μA776C

Input Bias Current vs Set Current

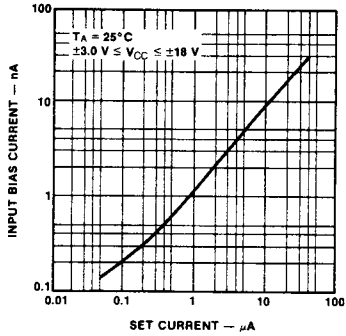

PC03981F

Input Bias Current vs Temperature

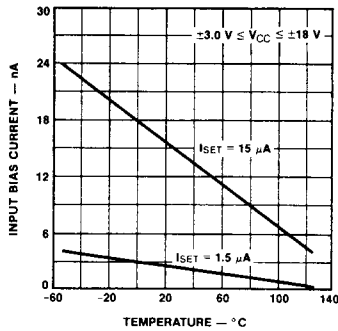

PC03990F

Input Offset Current vs Temperature

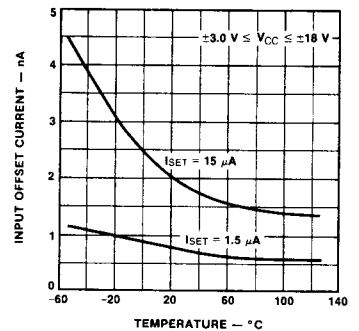

PC04000F

Change in Input Offset Voltage vs Set Current

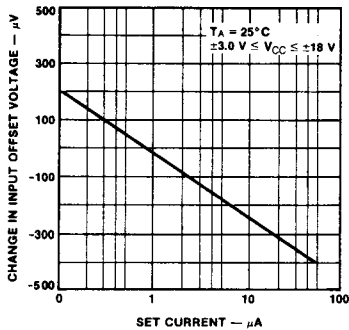

PC04011F

Change in Input Offset Voltage vs Temperature (Unnull)

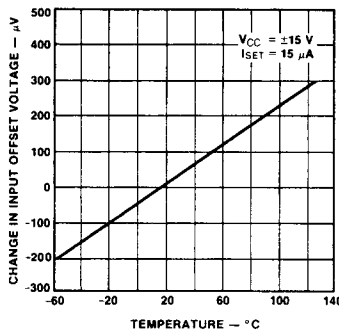

PC04020F

Input Noise Voltage vs Set Current

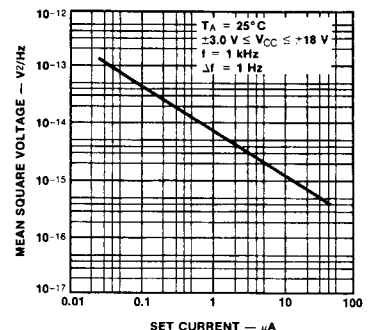

PC04031F

Input Noise Voltage and Current vs Frequency

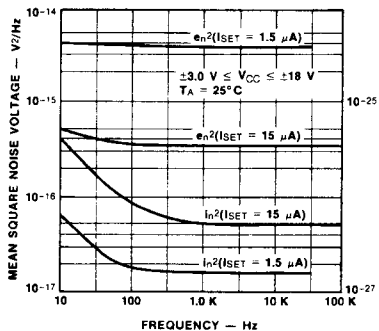

PC04041F

Input Noise Current vs Set Current

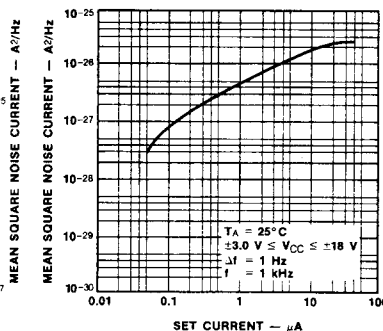

PC04051F

Optimum Source Resistor for Minimum Noise vs Set Current

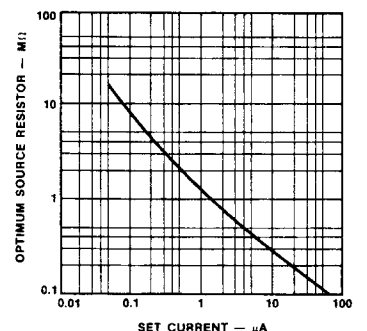

PC04061F

Typical Performance Curves for μA776 and μA776C (Cont.)

Output Voltage Swing vs Load Resistance

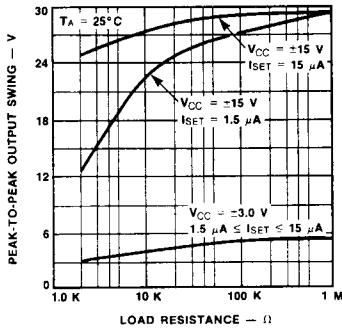

PC04071F

Output Voltage Swing vs Supply Voltage

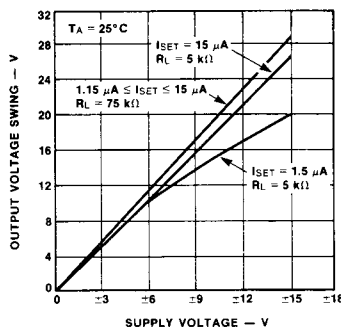

PC04080F

Gain Bandwidth Product vs Set Current

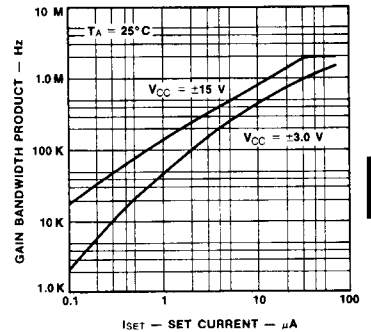

PC04091F

Voltage Gain vs Temperature

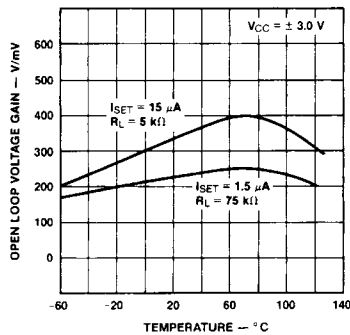

PC04101F

Voltage Gain vs Temperature

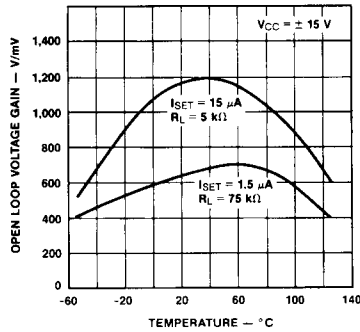

PC04111F

Power Supply Rejection Ratio vs Set Current

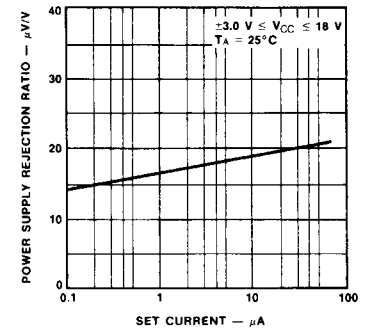

PC04121F

Supply Current vs Temperature

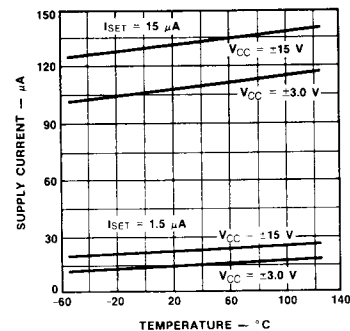

PC04130F

Standby Supply Current vs Set Current

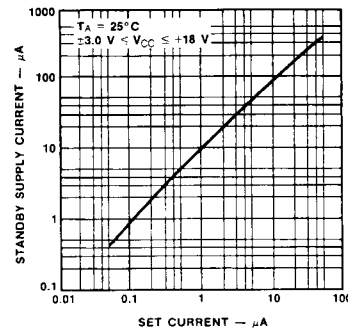

PC04141F

Thermal Response Of Input Offset Voltage To Step Change Of Case Temperature

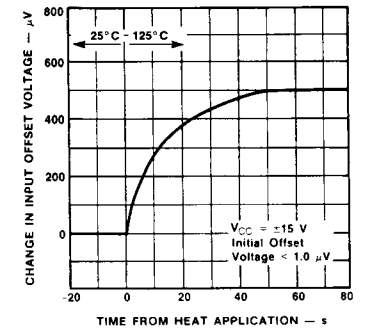

PC04151F

Typical Performance Curves for μA776 and μA776C (Cont.)

Stabilization Time Of Input Offset Voltage From Power On

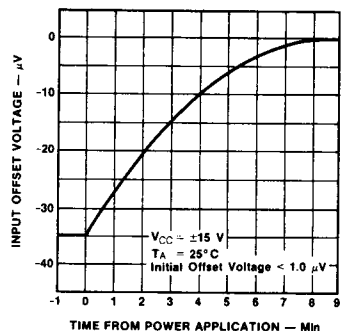

PC04161F

Input Offset Voltage Drift vs Time

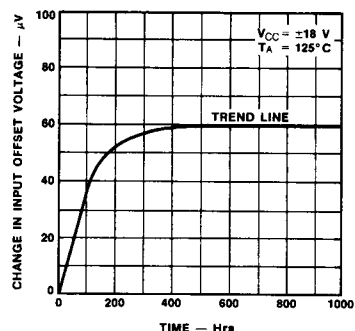

PC04171F

Slew Rate vs Set Current

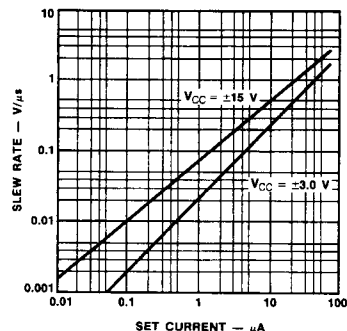

PC04181F

Voltage Follower Transient Response (Unity Gain)

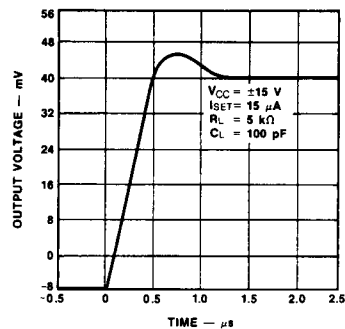

PC04201F

Set Current vs Set Resistor

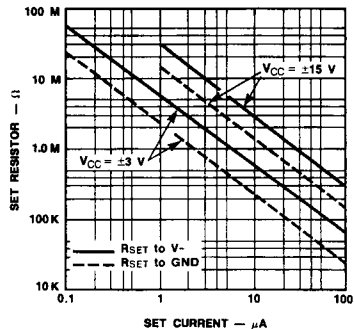

PC04191F

Quiescent Current Setting Resistor (ISET to V⁻)

V _S	I _{SET}	
	1.5 μA	15 μA
±1.5 V	1.7 MΩ	170 kΩ
±3.0 V	3.6 MΩ	360 kΩ
±6.0 V	7.5 MΩ	750 kΩ
±15 V	20 MΩ	2.0 MΩ

Note

The μA776 may be operated with R_{SET} connected to ground or V⁻.

I_{SET} Equations

$$I_{SET} = \frac{(V^+) - 0.7 - (V^-)}{R_{SET}}$$

where:

R_{SET} is connected to V⁻

$$I_{SET} = \frac{(V^+) - 0.7}{R_{SET}}$$

where:

R_{SET} is connected to ground.

Biasing Circuits

Resistor Biasing

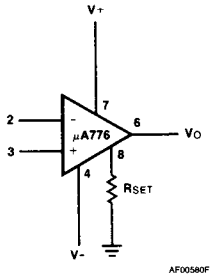

R_{SET} Connected to Ground

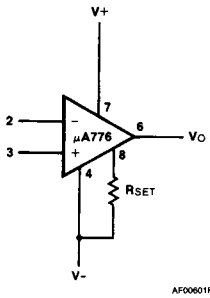

R_{SET} Connected to V_-
*Recommended for supply voltages less than ± 6 V.

Transistor Current Source Biasing

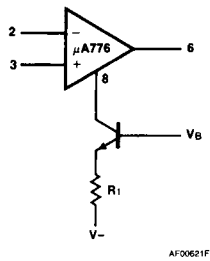

Voltage Offset Null Circuit

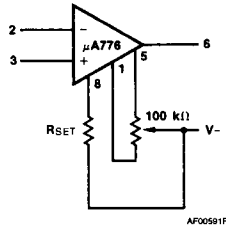

FET Current Source Biasing

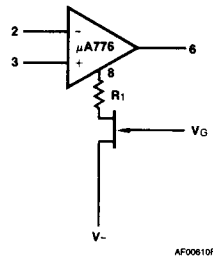

Transient Response Test Circuit

