

Introduction

The Atmel® ATmega128A is a low-power CMOS 8-bit microcontroller based on the AVR® enhanced RISC architecture. By executing powerful instructions in a single clock cycle, the ATmega128A achieves throughputs close to 1MIPS per MHz. This empowers system designer to optimize the device for power consumption versus processing speed.

Features

- High-performance, Low-power Atmel AVR 8-bit Microcontroller
- Advanced RISC Architecture
 - 133 Powerful Instructions - Most Single-clock Cycle Execution
 - 32 × 8 General Purpose Working Registers + Peripheral Control Registers
 - Fully Static Operation
 - Up to 16MIPS Throughput at 16MHz
 - On-chip 2-cycle Multiplier
- High Endurance Non-volatile Memory segments
 - 128Kbytes of In-System Self-programmable Flash program memory
 - 4Kbytes EEPROM
 - 4Kbytes Internal SRAM
 - Write/Erase cycles: 10,000 Flash/100,000 EEPROM
 - Data retention: 20 years at 85°C/100 years at 25°C⁽¹⁾
 - Optional Boot Code Section with Independent Lock Bits
 - In-System Programming by On-chip Boot Program
 - True Read-While-Write Operation
 - Up to 64 Kbytes Optional External Memory Space
 - Programming Lock for Software Security
 - SPI Interface for In-System Programming
- JTAG (IEEE std. 1149.1 Compliant) Interface
 - Boundary-scan Capabilities According to the JTAG Standard
 - Extensive On-chip Debug Support

This is a summary document. A complete document is available on our Web site at www.atmel.com

- Programming of Flash, EEPROM, Fuses and Lock Bits through the JTAG Interface
- Atmel QTouch® library support
 - Capacitive touch buttons, sliders and wheels
 - Atmel QTouch and QMatrix acquisition
 - Up to 64 sense channels
- Peripheral Features
 - Two 8-bit Timer/Counters with Separate Prescalers and Compare Modes
 - Two Expanded 16-bit Timer/Counters with Separate Prescaler, Compare Mode and Capture Mode
 - Real Time Counter with Separate Oscillator
 - Two 8-bit PWM Channels
 - 6 PWM Channels with Programmable Resolution from 2 to 16 Bits
 - Output Compare Modulator
 - 8-channel, 10-bit ADC
 - 8 Single-ended Channels
 - 7 Differential Channels
 - 2 Differential Channels with Programmable Gain at 1x, 10x, or 200x
 - Byte-oriented Two-wire Serial Interface
 - Dual Programmable Serial USARTs
 - Master/Slave SPI Serial Interface
 - Programmable Watchdog Timer with On-chip Oscillator
 - On-chip Analog Comparator
- Special Microcontroller Features
 - Power-on Reset and Programmable Brown-out Detection
 - Internal Calibrated RC Oscillator
 - External and Internal Interrupt Sources
 - Six Sleep Modes: Idle, ADC Noise Reduction, Power-save, Power-down, Standby, and Extended Standby
 - Software Selectable Clock Frequency
 - ATmega103 Compatibility Mode Selected by a Fuse
 - Global Pull-up Disable
- I/O and Packages
 - 53 Programmable I/O Lines
 - 64-lead TQFP and 64-pad QFN/MLF
- Operating Voltages
 - 2.7 - 5.5V
- Speed Grades
 - 0 - 16MHz

Table of Contents

Introduction.....	1
Features.....	1
1. Description.....	4
2. Configuration Summary.....	5
3. Ordering Information.....	6
4. Block Diagram.....	7
5. ATmega103 and ATmega128A Compatibility.....	8
5.1. ATmega103 Compatibility Mode.....	8
6. Pin Configurations.....	9
6.1. Pin Descriptions.....	9
7. Resources.....	12
8. Data Retention.....	13
9. About Code Examples.....	14
10. Capacitive Touch Sensing.....	15
11. Packaging Information.....	16
11.1. 64A.....	16
11.2. 64M1.....	17
12. Errata.....	18
12.1. ATmega128A Rev. U.....	18

1. Description

The Atmel AVR core combines a rich instruction set with 32 general purpose working registers. All the 32 registers are directly connected to the Arithmetic Logic Unit (ALU), allowing two independent registers to be accessed in one single instruction executed in one clock cycle. The resulting architecture is more code efficient while achieving throughputs up to ten times faster than conventional CISC microcontrollers.

The ATmega128A provides the following features: 128Kbytes of In-System Programmable Flash with Read- While-Write capabilities, 4Kbytes EEPROM, 4Kbytes SRAM, 53 general purpose I/O lines, 32 general purpose working registers, Real Time Counter (RTC), four flexible Timer/Counters with compare modes and PWM, 2 USARTs, one byte oriented Two-wire Serial Interface, an 8-channel, 10-bit ADC with optional differential input stage with programmable gain, programmable Watchdog Timer with Internal Oscillator, one SPI serial port, IEEE std. 1149.1 compliant JTAG test interface, also used for accessing the On-chip Debug system and programming and six software selectable power saving modes. The Idle mode stops the CPU while allowing the SRAM, Timer/Counters, SPI port, and interrupt system to continue functioning. The Power-down mode saves the register contents but freezes the Oscillator, disabling all other chip functions until the next interrupt or Hardware Reset. In Power-save mode, the asynchronous timer continues to run, allowing the user to maintain a timer base while the rest of the device is sleeping. The ADC Noise Reduction mode stops the CPU and all I/O modules except Asynchronous Timer and ADC, to minimize switching noise during ADC conversions. In Standby mode, the Crystal/Resonator Oscillator is running while the rest of the device is sleeping. This allows very fast start-up combined with low power consumption. In Extended Standby mode, both the main Oscillator and the Asynchronous Timer continue to run.

The device is manufactured using Atmel's high-density nonvolatile memory technology. The On-chip ISP Flash allows the program memory to be reprogrammed in-system through an SPI serial interface, by a conventional nonvolatile memory programmer, or by an On-chip Boot program running on the AVR core. The boot program can use any interface to download the application program in the application Flash memory. Software in the Boot Flash section will continue to run while the Application Flash section is updated, providing true Read- While-Write operation. By combining an 8-bit RISC CPU with In-System Self-Programmable Flash on a monolithic chip, the Atmel ATmega128A is a powerful microcontroller that provides a highly flexible and cost effective solution to many embedded control application

The ATmega128A AVR is supported with a full suite of program and system development tools including: C compilers, macro assemblers, program debugger/simulators, in-circuit emulators, and evaluation kits.

2. Configuration Summary

Features	ATmega128A
Pin count	64
Flash (KB)	128
SRAM (KB)	4
EEPROM (KB)	4
External Memory (KB)	64
General Purpose I/O pins	53
SPI	1
TWI (I ² C)	1
USART	2
ADC	10-bit, up to 76.9ksps (15ksps at max resolution)
ADC channels	6 (8 in TQFP and QFN/MLF packages)
AC propagation delay	Typ 400ns
8-bit Timer/Counters	2
16-bit Timer/Counters	2
PWM channels	6
RC Oscillator	+/-3%
VREF Bandgap	
Operating voltage	2.7 - 5.5V
Max operating frequency	16MHz
Temperature range	-55°C to +125°C
JTAG	Yes

3. Ordering Information

Speed (MHz)	Power Supply	Ordering Code ⁽²⁾	Package ⁽¹⁾	Operational Range
16	2.7 - 5.5V	ATmega128A-AU	64A	Industrial (-40°C to 85°C)
		ATmega128A-AUR ⁽³⁾	64A	
		ATmega128A-MU	64M1	
		ATmega128A-MUR ⁽³⁾	64M1	

Note:

1. This device can also be supplied in wafer form. Please contact your local Atmel sales office for detailed ordering information and minimum quantities.
2. Pb-free packaging, complies to the European Directive for Restriction of Hazardous Substances (RoHS directive). Also Halide free and fully Green.
3. Tape and Reel

Package Type	
64A	64-lead, 14 × 14 × 1.0 mm, Thin Profile Plastic Quad Flat Package (TQFP)
64M1	64-pad, 9 × 9 × 1.0 mm, Quad Flat No-Lead/Micro Lead Frame Package (QFN/MLF)

4. Block Diagram

Figure 4-1 Block Diagram

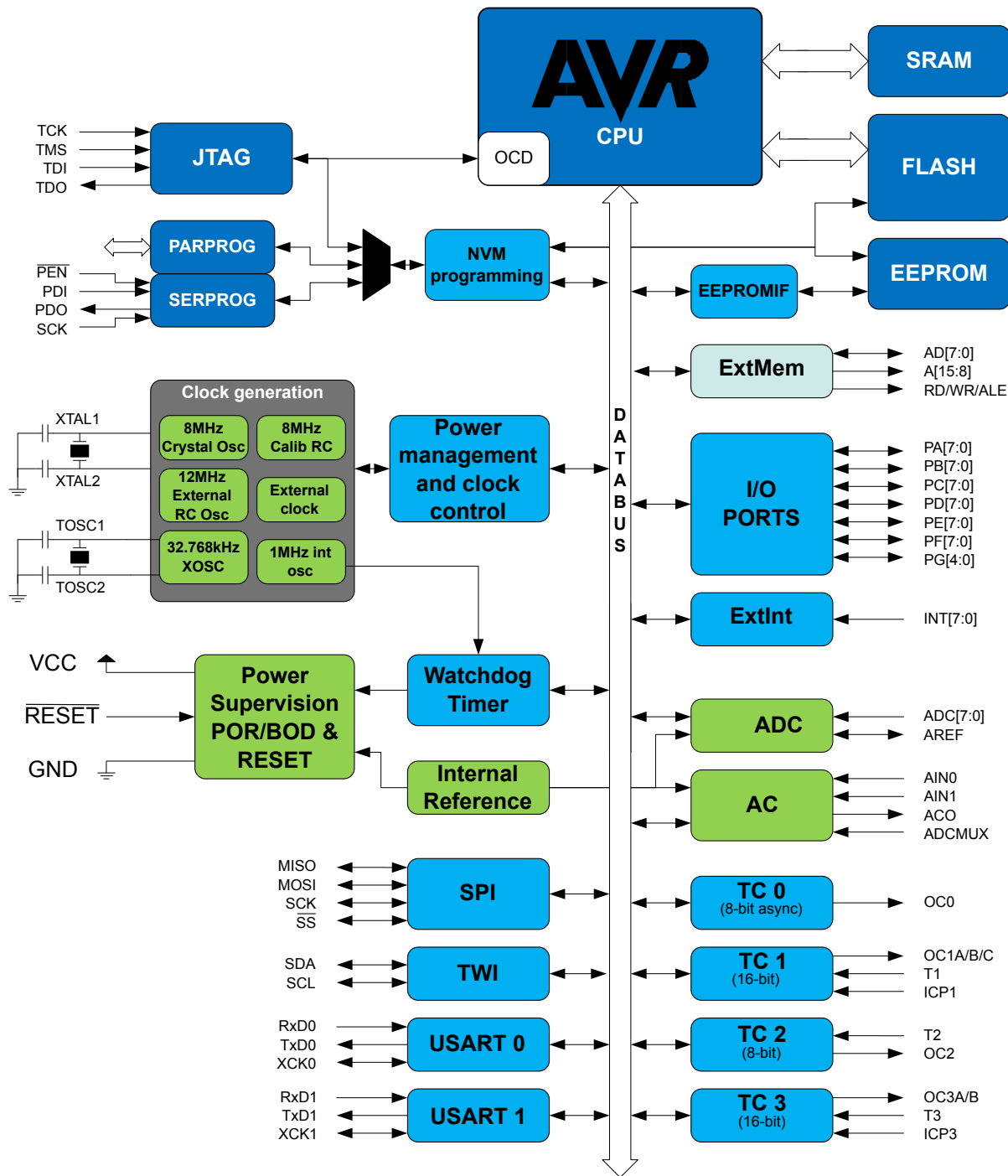

5. ATmega103 and ATmega128A Compatibility

The ATmega128A is a highly complex microcontroller where the number of I/O locations supersedes the 64 I/O locations reserved in the AVR instruction set. To ensure backward compatibility with the ATmega103, all I/O locations present in ATmega103 have the same location in ATmega128A. Most additional I/O locations are added in an Extended I/O space starting from 0x60 to 0xFF, (that is, in the ATmega103 internal RAM space). These locations can be reached by using LD/LDS/LDD and ST/STS/STD instructions only, not by using IN and OUT instructions. The relocation of the internal RAM space may still be a problem for ATmega103 users. Also, the increased number of interrupt vectors might be a problem if the code uses absolute addresses. To solve these problems, an ATmega103 compatibility mode can be selected by programming the fuse M103C. In this mode, none of the functions in the Extended I/O space are in use, so the internal RAM is located as in ATmega103. Also, the Extended Interrupt vectors are removed.

The Atmel AVR ATmega128A is 100% pin compatible with ATmega103, and can replace the ATmega103 on current Printed Circuit Boards. The application note “Replacing ATmega103 by ATmega128A” describes what the user should be aware of replacing the ATmega103 by an ATmega128A.

5.1. ATmega103 Compatibility Mode

By programming the M103C fuse, the ATmega128A will be compatible with the ATmega103 regards to RAM, I/O pins and interrupt vectors as described above. However, some new features in ATmega128A are not available in this compatibility mode, these features are listed below:

- One USART instead of two, Asynchronous mode only. Only the eight least significant bits of the Baud Rate Register is available.
- One 16 bits Timer/Counter with two compare registers instead of two 16-bit Timer/Counters with three compare registers.
- Two-wire serial interface is not supported.
- Port C is output only.
- Port G serves alternate functions only (not a general I/O port).
- Port F serves as digital input only in addition to analog input to the ADC.
- Boot Loader capabilities is not supported.
- It is not possible to adjust the frequency of the internal calibrated RC Oscillator.
- The External Memory Interface can not release any Address pins for general I/O, neither configure different wait-states to different External Memory Address sections.
- In addition, there are some other minor differences to make it more compatible to ATmega103:
- Only EXTRF and PORF exists in MCUCSR.
- Timed sequence not required for Watchdog Time-out change.
- External Interrupt pins 3 - 0 serve as level interrupt only.
- USART has no FIFO buffer, so data overrun comes earlier.

Unused I/O bits in ATmega103 should be written to 0 to ensure same operation in ATmega128A.

6. Pin Configurations

Figure 6-1 Pinout ATmega128A

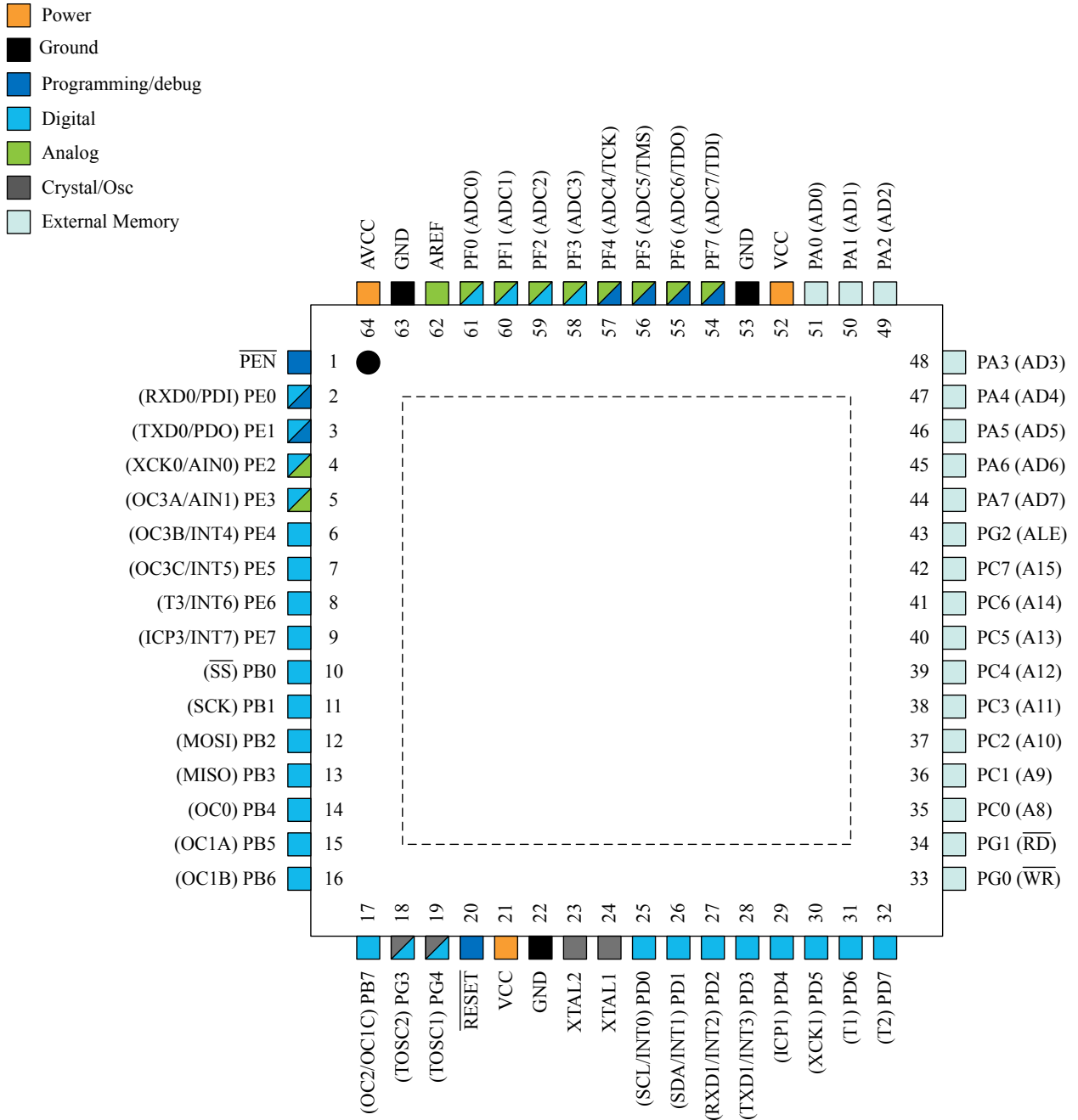

Note: The Pinout figure applies to both TQFP and MLF packages. The bottom pad under the QFN/MLF package should be soldered to ground.

6.1. Pin Descriptions

6.1.1. V_{CC}

Digital supply voltage.

6.1.2. GND

Ground.

6.1.3. Port A (PA7:PA0)

Port A is an 8-bit bi-directional I/O port with internal pull-up resistors (selected for each bit). The Port A output buffers have symmetrical drive characteristics with both high sink and source capability. As inputs, Port A pins that are externally pulled low will source current if the pull-up resistors are activated. The Port A pins are tristated when a reset condition becomes active, even if the clock is not running.

Port A also serves the functions of various special features of the ATmega128A as listed in *Alternate Functions of Port A*.

6.1.4. Port B (PB7:PB0)

Port B is an 8-bit bi-directional I/O port with internal pull-up resistors (selected for each bit). The Port B output buffers have symmetrical drive characteristics with both high sink and source capability. As inputs, Port B pins that are externally pulled low will source current if the pull-up resistors are activated. The Port B pins are tristated when a reset condition becomes active, even if the clock is not running.

Port B also serves the functions of various special features of the ATmega128A as listed in *Alternate Functions of Port B*.

6.1.5. Port C (PC7:PC0)

Port C is an 8-bit bi-directional I/O port with internal pull-up resistors (selected for each bit). The Port C output buffers have symmetrical drive characteristics with both high sink and source capability. As inputs, Port C pins that are externally pulled low will source current if the pull-up resistors are activated. The Port C pins are tristated when a reset condition becomes active, even if the clock is not running.

Port C also serves the functions of special features of the ATmega128A as listed in *Alternate Functions of Port C*. In ATmega103 compatibility mode, Port C is output only, and the port C pins are not tri-stated when a reset condition becomes active.

Note: The Atmel AVR ATmega128A is by default shipped in ATmega103 compatibility mode. Thus, if the parts are not programmed before they are put on the PCB, PORTC will be output during first power up, and until the ATmega103 compatibility mode is disabled.

6.1.6. Port D (PD7:PD0)

Port D is an 8-bit bi-directional I/O port with internal pull-up resistors (selected for each bit). The Port D output buffers have symmetrical drive characteristics with both high sink and source capability. As inputs, Port D pins that are externally pulled low will source current if the pull-up resistors are activated. The Port D pins are tristated when a reset condition becomes active, even if the clock is not running.

Port D also serves the functions of various special features of the ATmega128A as listed in *Alternate Functions of Port D*.

6.1.7. Port E (PE7:PE0)

Port E is an 8-bit bi-directional I/O port with internal pull-up resistors (selected for each bit). The Port E output buffers have symmetrical drive characteristics with both high sink and source capability. As inputs, Port E pins that are externally pulled low will source current if the pull-up resistors are activated. The Port E pins are tristated when a reset condition becomes active, even if the clock is not running.

Port E also serves the functions of various special features of the ATmega128A as listed in *Alternate Functions of Port E*.

6.1.8. Port F (PF7:PF0)

Port F serves as the analog inputs to the A/D Converter.

Port F also serves as an 8-bit bi-directional I/O port, if the A/D Converter is not used. Port pins can provide internal pull-up resistors (selected for each bit). The Port F output buffers have symmetrical drive characteristics with both high sink and source capability. As inputs, Port F pins that are externally pulled low will source current if the pull-up resistors are activated. The Port F pins are tri-stated when a reset condition becomes active, even if the clock is not running. If the JTAG interface is enabled, the pull-up resistors on pins PF7(TDI), PF5(TMS), and PF4(TCK) will be activated even if a Reset occurs.

The TDO pin is tri-stated unless TAP states that shift out data are entered.

Port F also serves the functions of the JTAG interface.

In ATmega103 compatibility mode, Port F is an input Port only.

6.1.9. Port G (PG4:PG0)

Port G is a 5-bit bi-directional I/O port with internal pull-up resistors (selected for each bit). The Port G output buffers have symmetrical drive characteristics with both high sink and source capability. As inputs, Port G pins that are externally pulled low will source current if the pull-up resistors are activated. The Port G pins are tristated when a reset condition becomes active, even if the clock is not running.

Port G also serves the functions of various special features.

The port G pins are tri-stated when a reset condition becomes active, even if the clock is not running.

In Atmel AVR ATmega103 compatibility mode, these pins only serves as strobes signals to the external memory as well as input to the 32kHz Oscillator, and the pins are initialized to PG0 = 1, PG1 = 1, and PG2 = 0 asynchronously when a reset condition becomes active, even if the clock is not running. PG3 and PG4 are oscillator pins.

6.1.10. RESET

Reset input. A low level on this pin for longer than the minimum pulse length will generate a reset, even if the clock is not running. The minimum pulse length is given in *System and Reset Characteristics*. Shorter pulses are not guaranteed to generate a reset.

6.1.11. XTAL1

Input to the inverting Oscillator amplifier and input to the internal clock operating circuit.

6.1.12. XTAL2

Output from the inverting Oscillator amplifier.

6.1.13. AV_{CC}

AV_{CC} is the supply voltage pin for Port F and the A/D Converter. It should be externally connected to V_{CC}, even if the ADC is not used. If the ADC is used, it should be connected to V_{CC} through a low-pass filter.

6.1.14. AREF

AREF is the analog reference pin for the A/D Converter.

6.1.15. PEN

PEN is a programming enable pin for the SPI Serial Programming mode, and is internally pulled high. By holding this pin low during a Power-on Reset, the device will enter the SPI Serial Programming mode. PEN has no function during normal operation.

7. Resources

A comprehensive set of development tools, application notes and datasheets are available for download on <http://www.atmel.com/avr>.

8. Data Retention

Reliability Qualification results show that the projected data retention failure rate is much less than 1 PPM over 20 years at 85°C or 100 years at 25°C.

9. About Code Examples

This datasheet contains simple code examples that briefly show how to use various parts of the device. These code examples assume that the part specific header file is included before compilation. Be aware that not all C compiler vendors include bit definitions in the header files and interrupt handling in C is compiler dependent. Please confirm with the C compiler documentation for more details.

For I/O registers located in extended I/O map, “IN”, “OUT”, “SBIS”, “SBIC”, “CBI”, and “SBI” instructions must be replaced with instructions that allow access to extended I/O. Typically “LDS” and “STS” combined with “SBR”, “SBRC”, “SBR”, and “CBR”.

10. Capacitive Touch Sensing

The Atmel QTouch Library provides a simple to use solution to realize touch sensitive interfaces on most Atmel AVR microcontrollers. The QTouch Library includes support for the QTouch and QMatrix[®] acquisition methods.

Touch sensing can be added to any application by linking the appropriate Atmel QTouch Library for the AVR Microcontroller. This is done by using a simple set of APIs to define the touch channels and sensors, and then calling the touch sensing API's to retrieve the channel information and determine the touch sensor states.

The QTouch Library is FREE and downloadable from the Atmel website at the following location: www.atmel.com/qtouchlibrary. For implementation details and other information, refer to the [Atmel QTouch Library User Guide](#) - also available for download from the Atmel website.

11. Packaging Information

11.1. 64A

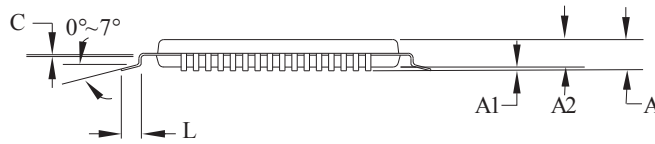
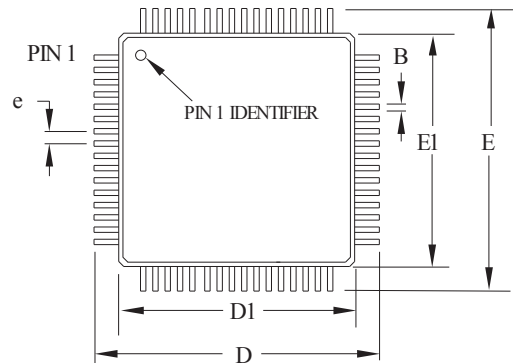

COMMON DIMENSIONS
(Unit of measure = mm)

SYMBOL	MIN	NOM	MAX	NOTE
A	-	-	1.20	
A1	0.05	-	0.15	
A2	0.95	1.00	1.05	
D	15.75	16.00	16.25	
D1	13.90	14.00	14.10	Note 2
E	15.75	16.00	16.25	
E1	13.90	14.00	14.10	Note 2
B	0.30-	0.45		
C	0.09	-	0.20	
L	0.45	-	0.75	
e	0.80 TYP			

Notes:

1. This package conforms to JEDEC reference MS-026, Variation AEB.
2. Dimensions D1 and E1 do not include mold protrusion. Allowable protrusion is 0.25mm per side. Dimensions D1 and E1 are maximum plastic body size dimensions including mold mismatch.
3. Lead coplanarity is 0.10mm maximum.

2010-10-20

	2325 Orchard Parkway San Jose, CA 95131	TITLE	DRAWING NO.	REV.
		64A, 64-lead, 14 x 14mm Body Size, 1.0mm Body Thickness, 0.8mm Lead Pitch, Thin Profile Plastic Quad Flat Package (TQFP)	64A	C

11.2. 64M1

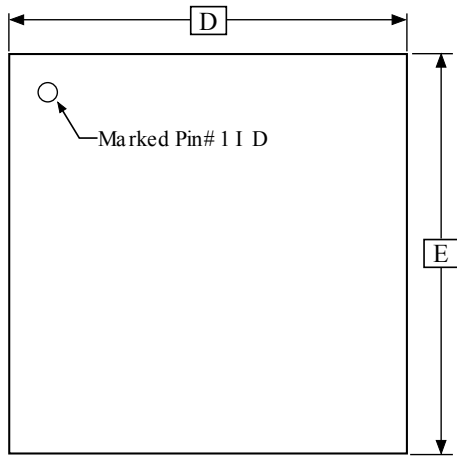

TOP VIEW

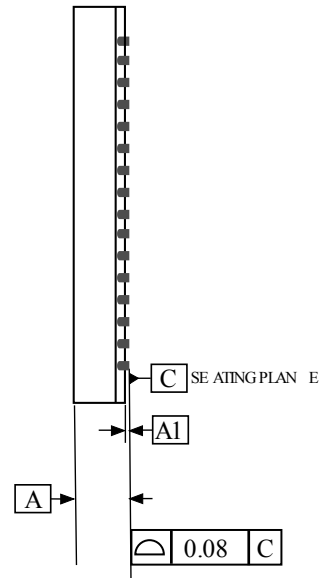

SIDE VIEW

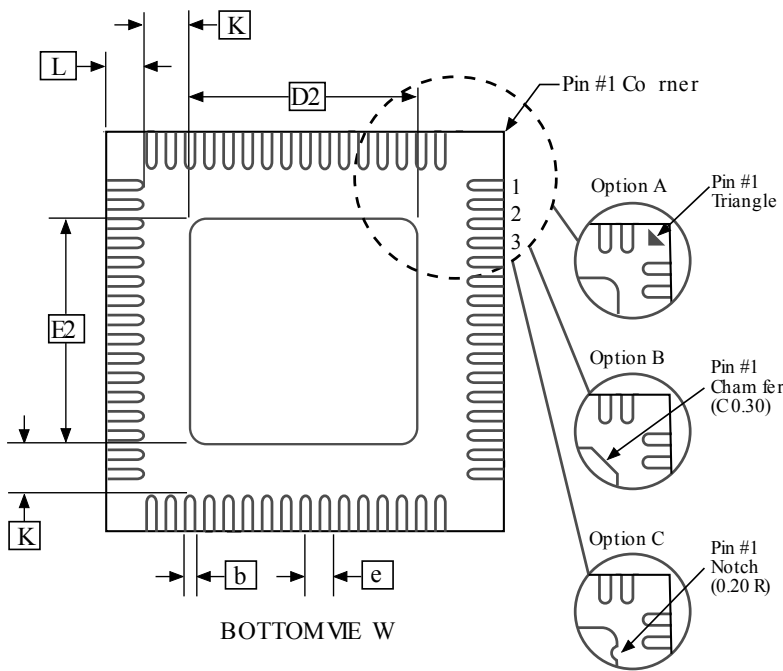

BOTTOM VIEW

COMMON DIMENSIONS
(Unit of Measure = mm)

SYMBOL	MIN	NOM	MAX	NOTE
A	0.80	0.90	1.00	
AI	-	0.02	0.05	
b	0.18	0.25	0.30	
D	8.90	9.00	9.10	
D2	5.20	5.40	5.60	
E	8.90	9.00	9.10	
E2	5.20	5.40	5.60	
e	0.50 BSC			
L	0.35	0.40	0.45	
K	1.25	1.40	1.55	

Notes:

1. JEDEC Standard MO-220, (S AW Singulation) Fig . 1, VMM D.
2. Dimension and tolerance conform to ASMEY14.5M-1994 .

2010-10-19

Atmel 2325 Orchard Parkway
San Jose, CA 95131

TITLE
64M1, 64-pad, 9 x 9 x 1.0 mm Body, Lead Pitch 0.50 mm,
5.40 mm Exposed Pad, Micro Lead Frame Package (MLF)

DRAWING NO. RE V.
64M1 H

12. Errata

The revision letter in this section refers to the revision of the ATmega128A device.

12.1. ATmega128A Rev. U

- First Analog Comparator conversion may be delayed
- Interrupts may be lost when writing the timer registers in the asynchronous timer
- Stabilizing time needed when changing XDIV Register
- Stabilizing time needed when changing OSCCAL Register
- IDCODE masks data from TDI input
- Reading EEPROM by using ST or STS to set EERE bit triggers unexpected interrupt request

1. First Analog Comparator conversion may be delayed

If the device is powered by a slow rising V_{CC} , the first Analog Comparator conversion will take longer than expected on some devices.

Problem Fix/Workaround

When the device has been powered or reset, disable then enable the Analog Comparator before the first conversion.

2. Interrupts may be lost when writing the timer registers in the asynchronous timer

The interrupt will be lost if a timer register that is synchronous timer clock is written when the asynchronous Timer/Counter register (TCNTx) is 0x00.

Problem Fix/Workaround

Always check that the asynchronous Timer/Counter register neither have the value 0xFF nor 0x00 before writing to the asynchronous Timer Control Register (TCCRx), asynchronous Timer Counter Register (TCNTx), or asynchronous Output Compare Register (OCRx).

3. Stabilizing time needed when changing XDIV Register

After increasing the source clock frequency more than 2% with settings in the XDIV register, the device may execute some of the subsequent instructions incorrectly.

Problem Fix/Workaround

The NOP instruction will always be executed correctly also right after a frequency change. Thus, the next 8 instructions after the change should be NOP instructions. To ensure this, follow this procedure:

- 3.1. Clear the I bit in the SREG Register.
- 3.2. Set the new pre-scaling factor in XDIV register.
- 3.3. Execute 8 NOP instructions
- 3.4. Set the I bit in SREG

This will ensure that all subsequent instructions will execute correctly.

Assembly Code Example:

```
CLI                ; clear global interrupt enable
OUT    XDIV, temp  ; set new prescale value
NOP                ; no operation
NOP                ; no operation
NOP                ; no operation
```

```
NOP          ; no operation
NOP          ; no operation
NOP          ; no operation
NOP          ; no operation
NOP          ; no operation
SEI          ; set global interrupt enable
```

4. **Stabilizing time needed when changing OSCCAL Register**

After increasing the source clock frequency more than 2% with settings in the OSCCAL register, the device may execute some of the subsequent instructions incorrectly.

Problem Fix/Workaround

The behavior follows errata number 3., and the same Fix / Workaround is applicable on this errata.

5. **IDCODE masks data from TDI input**

The JTAG instruction IDCODE is not working correctly. Data to succeeding devices are replaced by all-ones during Update-DR.

Problem Fix/Workaround

- If ATmega128A is the only device in the scan chain, the problem is not visible.
- Select the Device ID Register of the ATmega128A by issuing the IDCODE instruction or by entering the Test-Logic-Reset state of the TAP controller to read out the contents of its Device ID Register and possibly data from succeeding devices of the scan chain. Issue the BYPASS instruction to the ATmega128A while reading the Device ID Registers of preceding devices of the boundary scan chain.
- If the Device IDs of all devices in the boundary scan chain must be captured simultaneously, the ATmega128A must be the first device in the chain.

6. **Reading EEPROM by using ST or STS to set EERE bit triggers unexpected interrupt request.**

Reading EEPROM by using the ST or STS command to set the EERE bit in the EECR register triggers an unexpected EEPROM interrupt request.

Problem Fix/Workaround

Always use OUT or SBI to set EERE in EECR.

Atmel®, Atmel logo and combinations thereof, Enabling Unlimited Possibilities®, AVR®, and others are registered trademarks or trademarks of Atmel Corporation in U.S. and other countries. Other terms and product names may be trademarks of others.

DISCLAIMER: The information in this document is provided in connection with Atmel products. No license, express or implied, by estoppel or otherwise, to any intellectual property right is granted by this document or in connection with the sale of Atmel products. EXCEPT AS SET FORTH IN THE ATMEL TERMS AND CONDITIONS OF SALES LOCATED ON THE ATMEL WEBSITE, ATMEL ASSUMES NO LIABILITY WHATSOEVER AND DISCLAIMS ANY EXPRESS, IMPLIED OR STATUTORY WARRANTY RELATING TO ITS PRODUCTS INCLUDING, BUT NOT LIMITED TO, THE IMPLIED WARRANTY OF MERCHANTABILITY, FITNESS FOR A PARTICULAR PURPOSE, OR NON-INFRINGEMENT. IN NO EVENT SHALL ATMEL BE LIABLE FOR ANY DIRECT, INDIRECT, CONSEQUENTIAL, PUNITIVE, SPECIAL OR INCIDENTAL DAMAGES (INCLUDING, WITHOUT LIMITATION, DAMAGES FOR LOSS AND PROFITS, BUSINESS INTERRUPTION, OR LOSS OF INFORMATION) ARISING OUT OF THE USE OR INABILITY TO USE THIS DOCUMENT, EVEN IF ATMEL HAS BEEN ADVISED OF THE POSSIBILITY OF SUCH DAMAGES. Atmel makes no representations or warranties with respect to the accuracy or completeness of the contents of this document and reserves the right to make changes to specifications and products descriptions at any time without notice. Atmel does not make any commitment to update the information contained herein. Unless specifically provided otherwise, Atmel products are not suitable for, and shall not be used in, automotive applications. Atmel products are not intended, authorized, or warranted for use as components in applications intended to support or sustain life.

SAFETY-CRITICAL, MILITARY, AND AUTOMOTIVE APPLICATIONS DISCLAIMER: Atmel products are not designed for and will not be used in connection with any applications where the failure of such products would reasonably be expected to result in significant personal injury or death ("Safety-Critical Applications") without an Atmel officer's specific written consent. Safety-Critical Applications include, without limitation, life support devices and systems, equipment or systems for the operation of nuclear facilities and weapons systems. Atmel products are not designed nor intended for use in military or aerospace applications or environments unless specifically designated by Atmel as military-grade. Atmel products are not designed nor intended for use in automotive applications unless specifically designated by Atmel as automotive-grade.