

MASTECH[®] MS2030B

AC Digital Clamp Meter User's Manual

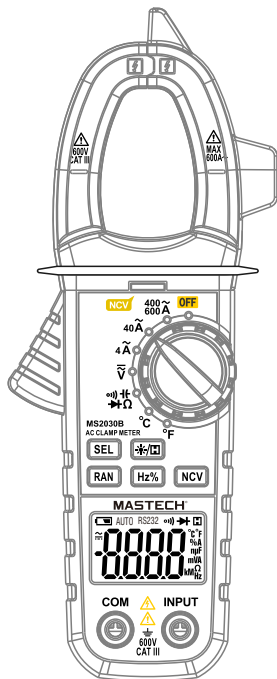

Intertek



CONTENTS

1. Introduction	1
2. Safety Information	1
2.1 Precautions	1
2.2 Safety Symbols.....	3
3. Description	4
3.1 Front Panel	4
3.2 Display	7
4. Using the Meter	8
4.1 Data Hold	8
4.2 Manual Range	8
4.3 Auto Power Off	8
4.4 DC Voltage.....	8
4.5 AC Voltage.....	9
4.6 AC Current	9

CONTENTS

4.7 Resistance	10
4.8 Diode Test.....	11
4.9 Continuity.....	11
4.10 Capacitance.....	12
4.11 Temperature	12
4.12 Frequency/Duty Cycle	12
4.13 NCV (Non-Contact Voltage)	13
5. Specifications	13
5.1 General Specifications.....	13
5.2 Technical Specifications.....	14
6. Maintenance	18
6.1 General Maintenance	18
6.2 Replacing the Batteries.....	19
6.3 Replacing Test Leads.....	19
7. Accessories	20

1. Introduction

WARNING

Make sure to read and follow all safety procedures to avoid electric shock and/or injury. If the equipment is used in a manner not specified by the manufacturer, the protection provided by the equipment may be impaired.

The meter is a safe, reliable, yet small handheld 3 ¼ digital clamp meter. Capable of measuring AC current, AC/DC voltage, resistance, capacitance, temperature, frequency/duty cycle, NCV, diode's forward voltage drop, and continuity, it's ideal for both home users and professionals.

2. Safety Instructions

The meter is designed and manufactured according to safety requirements of EN 61010-1:2010, EN 61010-2-032:2012, EN 61010-2-033:2012 on electronic measuring instrument and hand held digital multipurpose meter. And conforms to UL STD.61010-1,61010-2-032, 61010-2-033, Certified to CSA STD.C22.2 NO.61010-1, 61010-2-032,61010-2-033.The product meets with the requirements of 600V CAT III and pollution degree 2.

- All safety guidelines outlined should be followed otherwise the protection provided by the instrument may be impaired.
- Warning symbols in the manual alert users of potential dangerous situations.
- Precautions are to prevent the user from damaging the instrument or the test object.

2.1 Precautions

To avoid possible electric shock, personal injury or damage to the meter, please observe the following:

1. Before using the meter, check the meter for damage during transport.
2. Check the test leads for damage to the insulation or wires before use.

3. Ensure the meter works properly by testing a known voltage first. If not working properly, have the meter serviced before using.
4. Never exceed the protection limit values indicated in the specifications for each range of measurement.
5. Always use caution when making voltage measurements above 60V dc or 30V ac rms.
6. Make sure to use the correct input jack, function and range when measuring.
7. Do not place the meter in any environment with dust, explosive gas or vapor.
8. Always keep fingers behind the probe barriers.
9. Connect the common test lead first, then the hot lead. Disconnect in reverse order.
10. Turn off power and discharge capacitors before measuring resistance, diodes or continuity.
11. Failure to follow safety guidelines may prevent the meter's built in protection from working properly.
12. To avoid damage or incorrect readings, check for AC voltage present before making DC voltage measurements.
13. Do not use the meter with the battery cover not securely in place.
14. When the "" symbol appears, replace the batteries to avoid incorrect readings
15. Before opening the case, always disconnect test leads from all energized circuits.
16. Only use the test leads provided with the meter. Replace only with similar leads with matching specifications.
17. Do not touch input jacks during measurement to avoid electric shock.
18. Before switching functions, remove test leads from an circuit.

2.2 Safety Symbols

	Note-Important safety information, refer to the instruction manual.
	Application around and removal from UNINSULATED HAZARDOUS LIVE conductors is permitted.
	Caution, possibility of electric shock
	Equipment protected throughout by double insulation or reinforced insulation.
	Conforms to UL STD. 61010-1, 61010-2-032, 61010-2-033; Certified to CSA STD C22.2 NO. 61010-1, 61010-2-032, 61010-2-033
	Complies with European (EU) safety standards
	Earth (ground) TERMINAL
	Direct current
	Alternating current

CAT III: MEASUREMENT CATEGORY III is applicable to test and measuring circuits connected to the distribution part of the building's low-voltage MAINS installation.

CAT II: MEASUREMENT CATEGORY II is applicable to test and measuring circuits connected directly to utilization points (socket outlets and similar points) of the low-voltage MAINS installation.

CAT IV: MEASUREMENT CATEGORY IV is applicable to test and measuring circuits connected at the source of the building's low-voltage MAINS installation.

3. Description 3.1 Front Panel

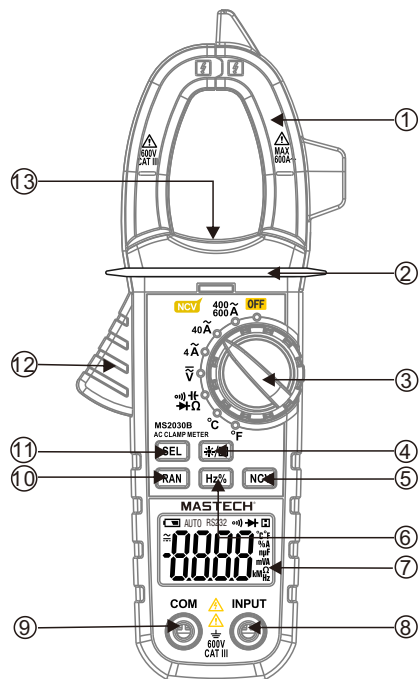

1. Current Clamp

For measuring AC current.



2. Safety barrier

Helps to keep hands from touching conductors while measuring current.

3. Rotary Switch

Used to select function and range.

4. Backlight/Hold button

Hold the  button to turn on the backlight. The worklight will turn on as well when the rotary switch is in one of the current positions. Hold down the button again to turn off the backlight. Press the  button and the display will keep the reading on the screen. The  symbol appears on the display. Press the "HOLD" button again to return the display to normal.

5. NCV Button

Hold the "NCV" button to activate the non-contact voltage mode.

6. Frequency/Duty Cycle Button

Press the "Hz%" button while in voltage mode to switch to frequency mode. Press the button again to switch to duty cycle mode. Press the button a third time to return to voltage mode.

7. Display

ax. display value: 3999

8. Input Jack

Connection for the live (red) test lead for voltage, resistance, capacitance, diodes and continuity.

9. COM Jack

Connection for the common (black) test lead.

10. Range Button

Press the "RAN" button to switch to manual range. Each press increases the range and returns to the lowest range when pressed in the highest range. Hold the button to return to auto-range.

11. Select Button

Press "SEL" to switch between AC/DC voltage and between functions in the multi-function position.

12. Clamp Trigger

Press the trigger to open the clamp jaw; release to close.

13. Worklight

When the rotary switch is in one of the current positions and the backlight is turned on, the worklight will also turn on.

3.2 Display

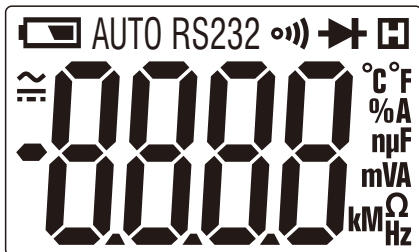

Symbol	Description
AUTO	Auto-range
— — —	Direct Current
~	Alternating Current
Battery icon	Low Battery
°C °F	Celsius/Fahrenheit
%	Percentage (duty cycle)
Hz, kHz	Hertz (frequency)
MV, V	Volts (Voltage)
μA, mA, A	Amps (Current)
nF, μF, mF	Farads (capacitance)
Ω, kΩ, MΩ	Ohms (resistance)
o)	Continuity
▶	Diode
□	Display Hold
◊	Polarity Indicator (Negative)

4. Using the Meter

4.1 Data Hold

The data hold function will keep the current reading on the display. To activate data hold:

1. Press the “ ” button and the reading will be held on the display. The “ ” symbol appears.
2. Press “ ” again to release the hold.

4.2 Manual Range

The meter's default range is “AUTO.” To select manual range, press “**RAN**” to enter manual range. Each press of the button increases the range and returns to the lowest range when pressed at the highest range. Hold the button to return to auto-range. Manual range cannot be used in 40A and 4A current modes, frequency, duty cycle, diode, continuity, or temperature modes

4.3 Auto Power Off

If the meter is not used for approx. 30 min., the meter will automatically turn itself off to conserve battery power. To turn the meter back on after auto off, press the “**SEL**” button.

4.4 DC Voltage

1. Insert the red test lead in the “INPUT” jack and the black lead in the “COM” jack.
2. Move the rotary switch to the “ ” position. The default mode is DC voltage. Connect the test leads across the circuit or load to be measured.
3. Read measured voltage on the display.

CAUTION

Use extra caution when measuring high voltages to avoid electric shock or damage.

WARNING

Do not attempt to measure voltages above 600V DC to prevent injury or damage to the meter.

4.5 AC Voltage

1. Insert the red test lead in the "INPUT" jack and the black lead in the "COM" jack.
2. Move the rotary switch to the  position. Press "SEL" to switch to AC voltage. Connect the test leads across the circuit or load to be measured.
3. Read measured voltage on the display.

CAUTION

Use extra caution when measuring high voltages to avoid electric shock or damage.

WARNING

Do not attempt to measure voltages above 600V AC to prevent injury or damage to the meter.



4.6 AC Current

1. Move the rotary switch to the  position with the proper range.
2. Press the trigger to open the clamp and insert one conductor inside the jaws. Only clamp one conductor; multiple conductors with different current directions will cancel out readings.
3. Read measured current on the display.

CAUTION

1. If the current range is not known before hand, set the range to the highest range and adjust down as necessary.
2. When measuring bare wires, use extra caution to avoid electric shock.

4.7 Resistance

1. Turn off all power and discharge capacitors on the circuit under test.
2. Insert the red test lead in the "INPUT" jack and the black lead in the "COM" jack. 
3. Move the rotary switch to the  position. Connect the test leads across the circuit to be measured.
4. Read measured resistance on the display.

Tips for measuring resistance:

- Sometimes the resistor value and measured resistance differ. This is due to the meter's output test current goes through all possible paths between leads.
- For low resistance measurements, short the test leads and record the resistance displayed. Then connect to the circuit and subtract the recorded resistance from the measurement for the most accurate results.
- When leads are disconnected or measurement is out of range, "OL" is displayed.

WARNING

To avoid injury or damage to the meter, make sure to turn off all power and discharge all capacitors before measuring resistance.

4.8 Diode Test

1. Turn off all power and discharge capacitors on the circuit under test.
2. Insert the red test lead in the “INPUT” jack and the black lead in the “COM” jack.
3. Move the rotary switch to the  position. Press “SEL” to switch to diode mode. Connect the test leads across the circuit to be measured.
4. Read the measured forward biased voltage drop on the display. If the leads are reversed, only “1” is displayed.

WARNING

To avoid injury or damage to the meter, make sure to turn off all power and discharge all capacitors before measuring diodes.

4.9 Continuity

1. Turn off all power and discharge capacitors on the circuit under test.
2. Insert the red test lead in the “INPUT” jack and the black lead in the “COM” jack.
3. Move the rotary switch to the  position. Press “SEL” twice to switch to continuity mode. Connect the test leads across the circuit to be measured.
4. Read measured resistance on the display. If the measured resistance is less than 60Ω, the meter’s buzzer will sound.

WARNING

To avoid injury or damage to the meter, make sure to turn off all power and discharge all capacitors before measuring continuity.

4.10 Capacitance

1. Turn off all power and discharge capacitors on the circuit under test.
2. Insert the red test lead in the “INPUT” jack and the black lead in the “COM” jack.
3. Move the rotary switch to the  position. Press “SEL” three times to switch to capacitance mode. Connect the test leads across the circuit to be measured.
4. Read measured capacitance on the display.

4.11 Temperature

1. Move the rotary switch to the “°C” or “°F” position. The display will show the current ambient temperature.
2. Connect the red end of the included type-k thermocouple to the “INPUT” jack and the black end to the “COM” jack.
3. Touch the tip of the thermocouple to the object to be tested.
4. Read measured resistance on the display.

4.12 Frequency/Duty Cycle

1. Insert the red test lead in the “INPUT” jack and the black lead in the “COM” jack.
2. Move the rotary switch to the  position. While in voltage mode, press “Hz%” to switch to frequency mode. Connect the test leads across the circuit to be measured.
3. Read measured resistance on the display.
4. Press “Hz%” again to switch to duty cycle mode. Connect the test leads across the circuit to be measured.
5. Read measured duty cycle on the display.
6. Press “Hz%” to return to voltage mode.

4.13 NCV (Non-Contact Voltage)

1. Move the rotary switch to any position.
2. Hold the "NCV" button and move the tip of the clamp close to the test object. If the detected voltage is > 110V AC, the meter will beep and the NCV indicator will flash.

Note:

1. Even if no indication is given, voltage may still be present. Do not rely solely on NCV detection to determine the presence of voltage.
2. When measuring AC/DC voltage, the NCV indicator may flash due to induced voltage.
3. External power sources/interference may trigger the NCV indicator.

5. Specifications

5.1 General Specifications

- Safety rating: CAT III 600V, pollution degree 2
- Max. operating altitude: 2000m
- Operating temperature: 0~40°C, <80% RH
- Storage temperature: -10~60°C, <70% RH (battery removed)
- Temperature coefficient: 0.1 accuracy/°C (<18°C or >28°C)
- Max. voltage between terminals and ground: 600V DC or AC rms
- Sample rate: approx. 3 times/sec
- Display: 3 ¾ digit LCD (max. display: 3999)
- Over-range indication: display only shows "OL"
- Low battery indication: when battery voltage drops below operating voltage, "⎓" symbol appears on the display
- Polarity indication: automatically displays "-"
- Power: 3x 1.5V AAA batteries
- Dimensions: 198mmX79mmX38mm
- Weight: approx. 196g (with battery)
- Max. jaw opening: 26mm

5.2 Technical Specifications

Accuracy: ±(% of reading + digits), 1 year warranty.
 Ambient temp: 18°C~28°C, humidity: <75%.
 Temperature coefficient: 0.1 accuracy/°C
 (0°C~18°C or 28°C~40°C)

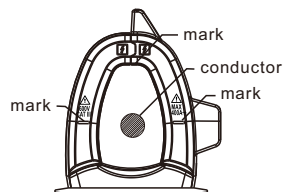

For AC current measurement, keep the conductor in the center of the clamp; otherwise the reading can deviate as much as 1.5% of actual measurement.

5.2.1 DC Voltage

Range	Resolution	Accuracy
400mV	0.1mV	±(0.8% of reading+3 digits)
4V	1mV	
40V	10mV	
400V	0.1V	
600V	1V	

- Input impedance: 10M
- Overload protection: 600V DC or AC rms
- Max. input voltage: 600V DC

5.2.2 AC Voltage

Range	Resolution	Accuracy
400mV	0.1mV	±(1.0% of reading+5 digits)
4V	1mV	
40V	10mV	
400V	0.1V	
600V	1V	

- Input impedance: 10MΩ
- Overload protection: 600V DC or AC rms
- Max. input voltage: 600V DC
- Frequency range: 40Hz~400Hz
- Response: Average; calibrated to rms sine wave

5.2.3 AC Current

Range	Resolution	Accuracy
4A	0.001A	±(2.5% of reading+5 digits)
40A	0.01A	
400A	0.1A	
600A	1A	

- Frequency range: 50Hz~60Hz
- Max. input current: up to 120% of full scale for no more than 60 seconds.
- Response: Average; calibrated to rms sine wave

5.2.4 Resistance

Range	Resolution	Accuracy
400Ω	0.1Ω	±(1.0% of reading+5 digits)
4KΩ	1Ω	
40KΩ	10Ω	
400KΩ	0.1KΩ	
4MΩ	1KΩ	±(2.0% of reading+5 digits)
40MΩ	10KΩ	

- Open circuit voltage: approx. 0.4V
- Overload protection: 250V DC or AC rms

5.2.5 Diode Test

Range	Resolution	Accuracy
	0.001V	Shows approx. forward biased voltage drop

- Forward DC current: approx. 1mA
- Reverse DC voltage: approx. 1.5V
- Overload protection: 250V DC or AC rms

5.2.6 Continuity

Range	Function
	If the measured resistance is less than 60Ω, the meter's buzzer will sound.

- Open circuit voltage: approx. 0.4V
- Overload protection: 250V DC or AC rms

5.2.7 Capacitance

Range	Resolution	Accuracy
5.0nF	0.001nF	±(4.0% of reading+5 digits)
50nF	0.01nF	±(3.0% of reading+3 digits)
500nF	0.1nF	
5.0µF	1nF	
50µF	0.01µF	
100µF	0.1µF	

- Overload protection: 250V DC or AC rms

5.2.8 Frequency (V position)

Range	Resolution	Accuracy
50Hz	0.01Hz	±(1.0% of reading+5 digits)
500Hz	0.1Hz	
5kHz	1Hz	
10kHz	0.01kHz	

- Measuring range: 10~100kHz.

- Input voltage range: ≥0.2V AC rms. (measured frequency will increase as the input voltage increases)

- Overload protection: 600V DC or AC rms

5.2.9 Duty Cycle

Range	Resolution	Accuracy
0.1%~99.9%	0.1%	±2.0%

5.2.10 Temperature

Range	Resolution	Accuracy
-20~1000°C	1°C	±(3% of reading+3 digits)
-4~1832°F	1°F	

6.Maintenance

WARNING

Protection impairment if used in a manner not specified by the manufacturer.

6.1 General Maintenance

This section provides basic maintenance principles, including cleaning and battery replacement. Do not attempt to do any repair or calibration to the meter unless you are experienced maintenance personnel.

WARNING

Remove test leads from meter before opening the battery cover to avoid damage or injury.

Use a damp cloth and a small amount of detergent to clean the meter regularly. Do not use abrasives or chemical solvents. Dirty or wet input jacks can affect readings.

To clean the input jacks:

1. Turn off meter and remove test leads.
2. Wipe any debris off input jacks.
3. Use a cotton swab with a cleaner/lubricant (i.e. WD-40) to clean jacks.
4. Use a new swab for each jack to prevent cross contamination.

6.2 Replacing The Batteries

⚠ WARNING

To avoid electric shock, make sure that the test leads have been clearly move away from the circuit under measurement before opening the battery cover of the meter.

⚠ WARNING

Do not mix old and new batteries. Do not mix alkaline, standard (carbon-zinc), or rechargeable (ni-cad, ni-mh, etc) batteries.

- 5.1.1 If the sign “” appears, it means that the batteries should be replaced.
- 5.1.2 Loosen the fixing screw of the battery cover and remove it.
- 5.1.3 Replace the exhausted batteries with new ones.
- 5.1.4 Put the battery cover back and fix it again to its origin form.

Note:

Do not reverse the polarity of the batteries.

6.3 Replacing Test Leads

Replace test leads if leads become damaged or worn.

⚠ WARNING

Use meet EN 61010-031 standard, rated CAT III 600V, or better test leads.

7. Accessories

User's manual	1 piece
Test leads	1 pair
Type-K Thermocouple	1 piece
Carry case	1 piece
AAA batteries (1.5V)	3 pieces

