

## LTV-200/205/206/207/208

Optocouplers, Phototransistor Output, Dual Channel,  
SOP8 Package



### Description

The LTV-200/205/206/207/208 are consist of a high efficient Gallium Arsenide Infrared LED and a Silicon NPN phototransistor. This design provides excellent isolation between the input and output sides of the Optocoupler.

The LTV-200/205/206/207/208 come in a standard SOP8 small outline package for surface mounting which makes it ideally suited for high density application with limited space.

A Specific CTR range allows a narrow tolerance in the electrical design of the adjacent circuits.

### Features

- Two Channel Coupler
- SOP8 surface mountable Package
- Isolation Voltage 3.75KV
- UL, CSA in progress

### Application

- Feedback Control Circuits
- Feedback element in switching mode power supplier
- Monitor & Detection Circuits

### Functional Diagram

Pin No. and Internal connection diagram

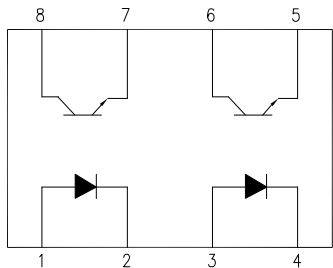

1,3. Anode  
2,4. Cathode

5,7. Emitter  
6,8. Collector

### Order Information

P/N	Remarks
LTV-200	CTR > 20%, SOP8
LTV-205	CTR 40-80%, SOP8
LTV-206	CTR 63-125%, SOP8
LTV-207	CTR 100-200%, SOP8
LTV-208	CTR 160-320%, SOP8

## Package Dimensions

SOP8 Package (LTV-200/205/206/207/208)

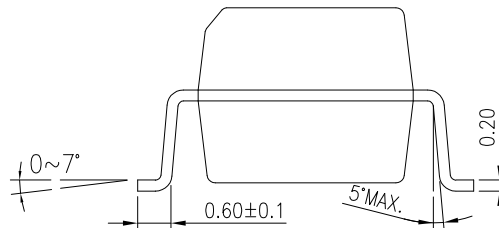
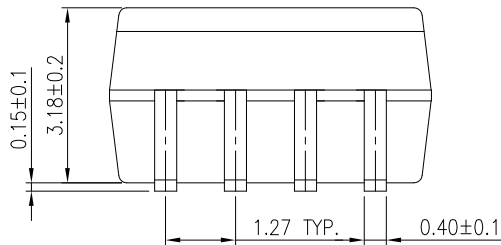
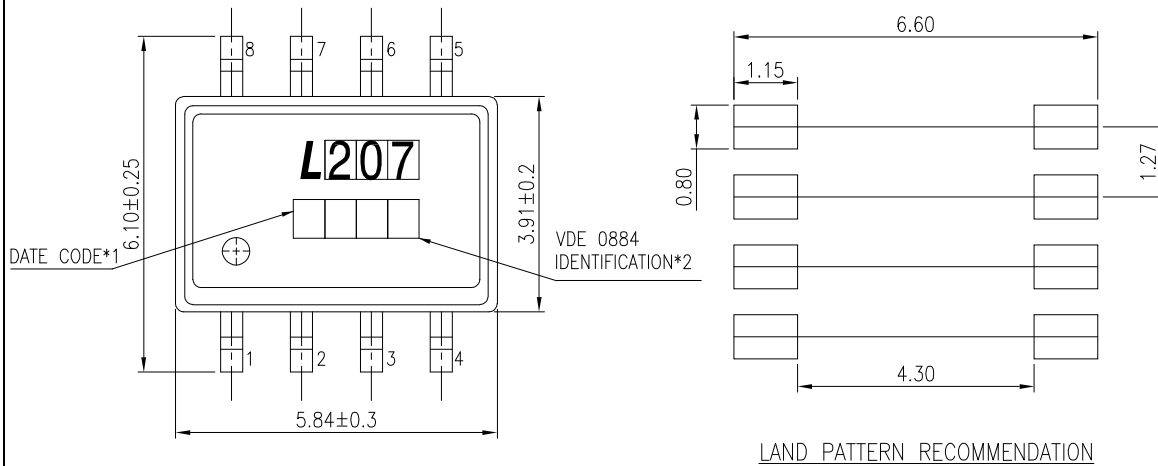

- \*1. Date code
- \*2. "V" to represent VDE0884

Dimensions are all in Millimeters.

## Taping Dimensions

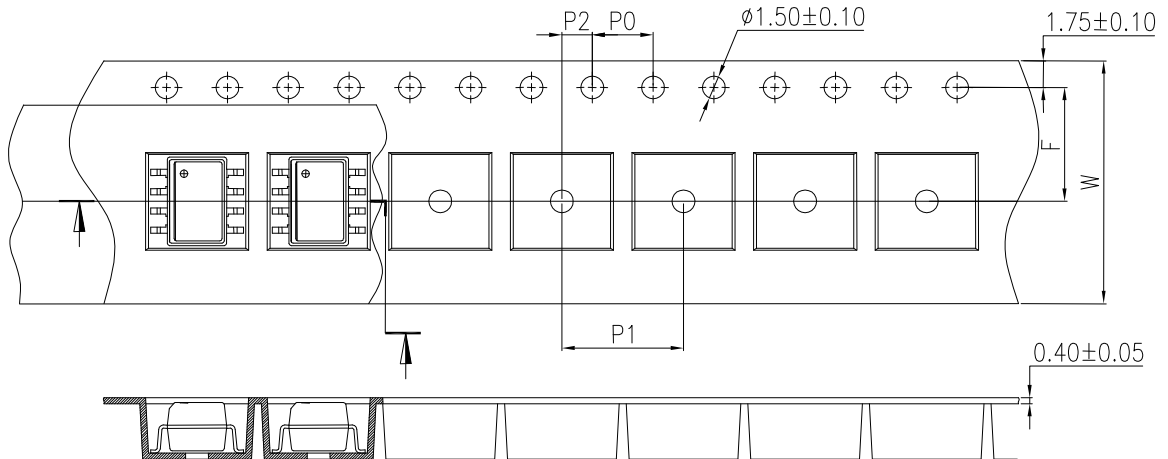

Description	Symbol	Dimensions in millimeters ( inches )
Tape wide	W	16.0±0.30(0.63)
Pitch of sprocket holes	P0	4.0±0.10(0.15)
Distance of compartment	F P2	7.5±0.10(0.295) 2±0.10(0.079)
Distance of compartment to compartment	P1	8.0±0.10(0.47)

## Quantities Per Reel

Package Type	LTV-200 / 205 / 206 / 207 / 208
Quantities (pcs)	3000

## Recommended Lead Free Reflow Profile

One time soldering reflow is recommended within the conditions below:

Profile item	Conditions
Preheat - Temperature Min (T <sub>smin</sub> ) - Temperature Max (T <sub>smax</sub> ) - Time (Min to Max) (T <sub>s</sub> )	150°C 180°C 90±30°C
Soldering zone - Temperature (T <sub>L</sub> ) - Time (t <sub>L</sub> )	250°C 10~15 sec
Peak temperature (T <sub>P</sub> )	260°C
Ramp-down rate	3°~ 6°C / sec

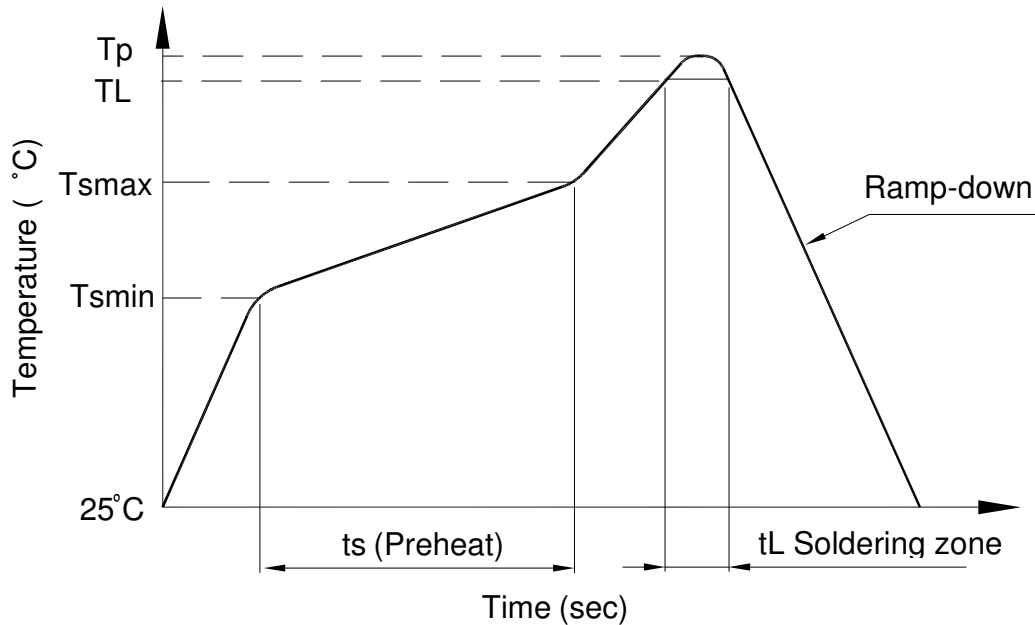

**Absolute Maximum Ratings\*1**

Temp. = 25°C

Parameter	Symbol	Value	Units	Note
Storage Temperature	$T_{ST}$	-55 ~ 150	°C	
Operating Temperature	$T_A$	-55 - 110	°C	
Isolation Voltage	$V_{ISO}$	3750	$V_{RMS}$	
Peak Pulse Current, 1us 300pps	$I_{peak}$	1	A	
Lead Solder Temperature * 2		260	°C	2
<b>Input</b>				
Average Forward Input Current per channel	$I_F$	30	mA	
Reverse Input Voltage	$V_R$	6	V	
Input Power Dissipation	$P_I$	50	mW	
<b>Output</b>				
Corrector-emitter Breakdown Voltage	$BV_{ceo}$	80	V	
Emitter-corrector Breakdown Voltage	$BV_{eco}$	7	V	
Output Collector Power Dissipation	$P_O$	125	mW	

1. Ambient temperature = 25°C, unless otherwise specified. Stresses exceeding the absolute maximum ratings can cause permanent damage to the device. Exposure to absolute maximum ratings for long periods of time can adversely affect reliability.

2. 260°C for 10 seconds. Refer to Lead Free Reflow Profile.

## Electrical Specifications

Parameters	Test Condition	Symbol	Min	Typ	Max	Units
<b>Input</b>						
Input Forward Voltage	$I_F = 10\text{mA}$	$V_F$		1.2	1.55	V
Input Reverse Current	$V_R = 6\text{V}$	$I_R$		0.1	100	$\mu\text{A}$
Capacitance	$V_R = 0\text{V}$	$C_i$		25		pF
<b>Detector</b>						
Corrector-emitter Breakdown Voltage	$I_c = 10\mu\text{A}$	$BV_{ceo}$	80			V
Emitter-corrector Breakdown Voltage	$I_E = 10\mu\text{A}$	$BV_{eco}$	7			V
Corrector-emitter Leakage Current	$V_{CE} = 10\text{V}, I_F = 0\text{mA}$	$I_{CEO}$		5	50	nA
Corrector-emitter Capacitance	$V_{CE} = 0\text{V}$	$C_{CE}$		10		pF
<b>Coupler</b>						
Corrector-emitter Saturation Voltage	$I_F = 10\text{mA}, I_c = 2.5\text{mA}$	$V_{ce(sat)}$			0.4	V
Input-output Capacitance		$C_{IO}$		0.5		pF
Isolation Test Voltage	$RH \leq 50\%, t = 1\text{min},$	$V_{ISO}$	3750			V
Resistance, Input to Output	$V_{I-O} = 500\text{V DC}$	$R_{ISO}$		$10^{12}$		$\Omega$

\*All Typical at  $T_A = 25^\circ\text{C}$

## Current Transfer Ratio

Parameter	Test Condition	Part	Min	Typ	Max	Units
DC Current Transfer Ratio	$V_{CE} = 5V, I_F = 10mA$	LTV-200	20			%
		LTV-205	40		80	%
		LTV-206	63		125	%
		LTV-207	100		200	%
		LTV-208	160		320	%
	$V_{CE} = 5V, I_F = 1mA$	LTV-205	13			%
		LTV-206	22			%
		LTV-207	34			%
		LTV-208	48			%

## Switching Specifications

Parameter	Test Condition	Symbol	Min	Typ	Max	Units
Turn-on Time	$I_C=2mA, R_L=100\Omega$ $V_{CC}=5V$	ton		5		$\mu s$
Turn-off Time	$I_C=2mA, R_L=100\Omega$ $V_{CC}=5V$	toff		4		$\mu s$

\*All Typical at  $T_A = 25^\circ C$

## Test Circuit for Response Time

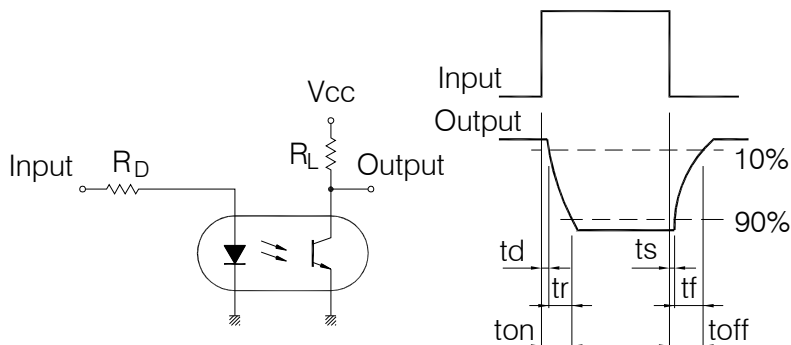

## Characteristics Curves

Figure1. Forward Current vs. Forward Voltage

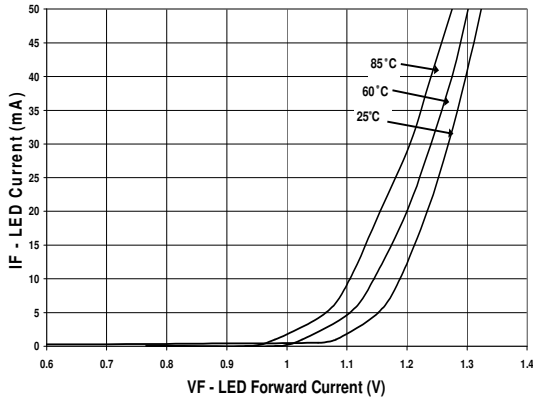

Figure2. Collector-Emitter Voltage vs. Collector Current

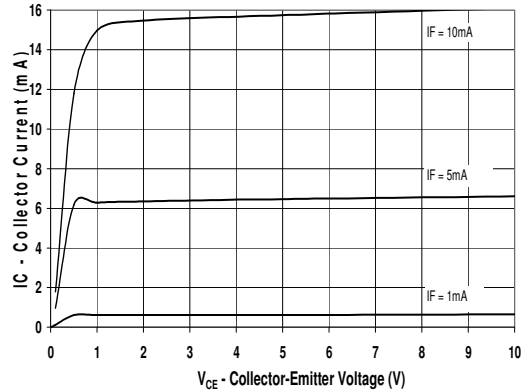

Figure3. CTR vs. Forward Current

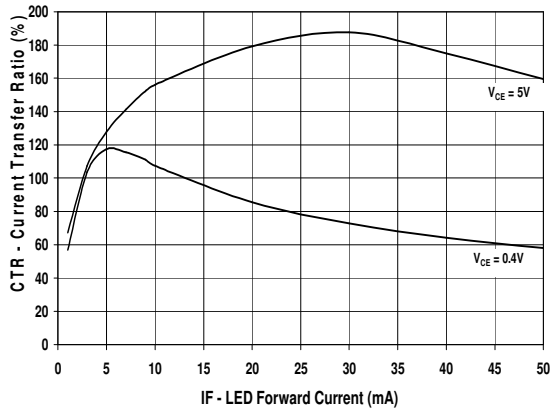

Figure4. Current Transfer Ratio vs. Ambient Temperature

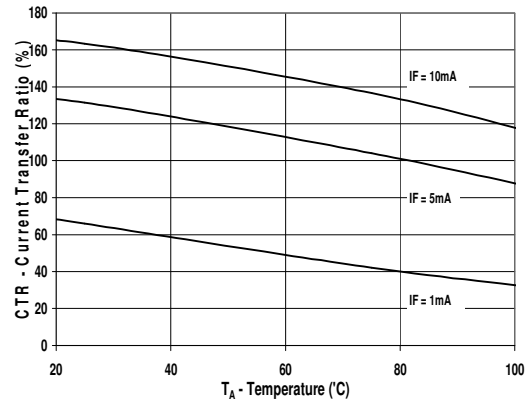

Figure5. Switching Speed vs. Load Resistor

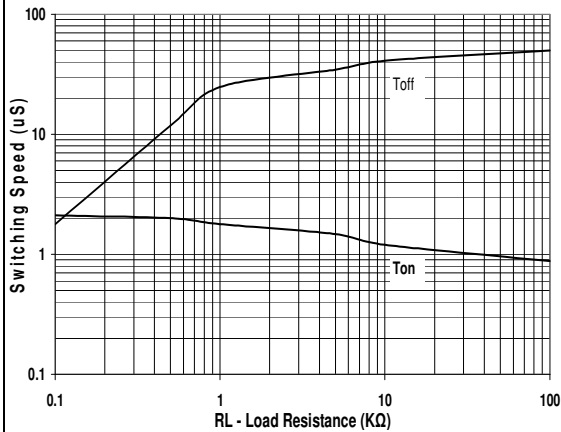
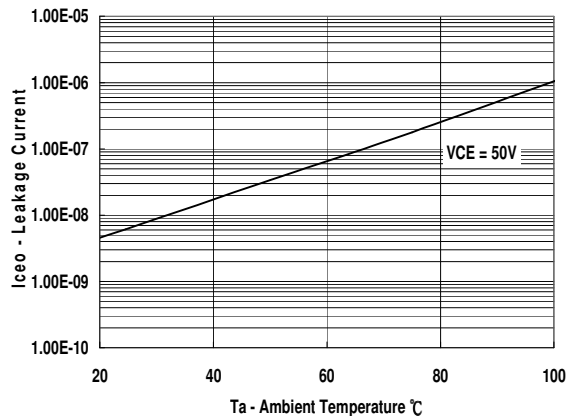
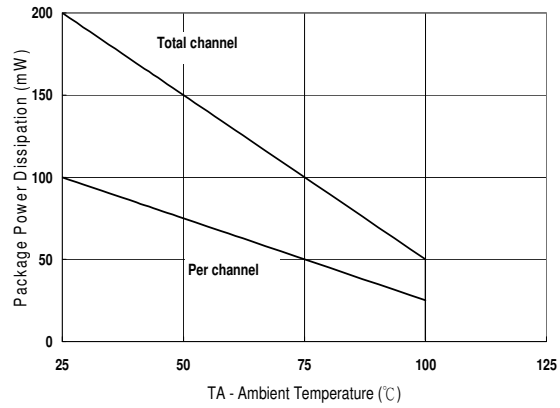

Figure6. Collector Leakage Current vs. Ambient Temperature



## Characteristics Curves

Figure7. Power Dissipation vs. Ambient Temperature



### **Notice**

Specifications of the products displayed herein are subject to change without notice.  
The products shown in this publication are designed for the general use in electronic applications such as office automation equipment, communications devices, audio/visual equipment, electrical instrumentation and application. For equipment/devices where high reliability or safety is required, such as space applications, nuclear power control equipment, medical equipment, etc, please contact our sales representatives.