

PCB Support Series

KLS8-0215 PCB Support Series

Material: UL approved Nylon 66, 94V-2

Unit:mm

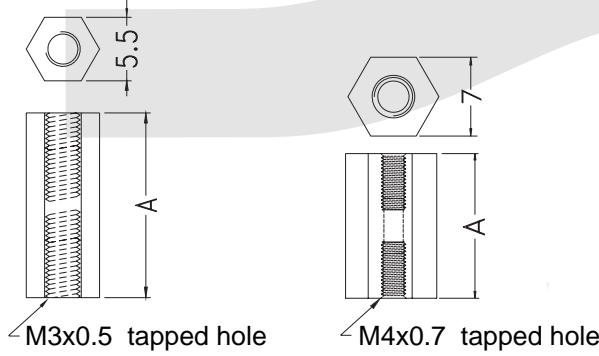

Model No.	A	Packaging
M3-04	4.0	1000PCS
M3-05	5.0	
M3-06	6.0	
M3-07	7.0	
M3-08	8.0	
M3-09	9.0	
M3-10	11.0	
M3-11	11.0	
M3-12	12.0	
M3-13	13.0	
M3-14	14.0	
M3-15	15.0	
M3-16	16.0	
M3-17	17.0	
M3-18	18.0	
M3-19	19.0	
M3-20	20.0	

Model No.	A	Packaging
M3-22	22.0	1000PCS
M3-25	25.0	
M3-27	27.0	
M3-30	30.0	
M3-32	32.0	
M3-35	35.0	
M3-38	38.0	
M3-42	42.0	
M3-45	45.0	
M3-47	47.0	
M3-49	49.0	
M3-50	50.0	

Model No.	A	Packaging
M4-06	6.0	1000PCS
M4-08	8.0	
M4-09	9.0	
M4-9.5	9.5	
M4-10	10.0	
M4-12A	12.0	
M4-12	12.7	
M4-14	14.0	
M4-15	15.0	
M4-16	16.0	
M4-17	17.0	
M4-18	18.0	
M4-19	19.0	
M4-20	20.0	
M4-22	22.0	
M4-25	25.0	
M4-30	30.0	

ORDER INFORMATION

KLS8-0215 - M3-04

