

STRADA-A-XP LENSES FOR CREE XP-E LEDs



- Specially designed for Cree XP-E series of LEDs.
- New extremely wide street light design, vertically wider version coming soon.
- With the result of an extremely creative design lens itself tilts automatically light 4 degrees.
- Special care taken to make a uniform white or warm white illumination. Lenses work well with other colors, too.
- Lens material optical grade PMMA. Allows use of high current and temperature conditions
- Best available optical efficiency, approximately 94%.
- Fastening to heat sink with or without PU foam adhesive tape of automotive grade, please select which suits the best for your needs.

LENS TYPES

NAME	ORDERING CODE	FWHM Angle
Strada-A-XP	C10818_Strada-A-XP	check measurement data below
Strada-A-XP-TAPE	CA10823_Strada-A-XP-tape	

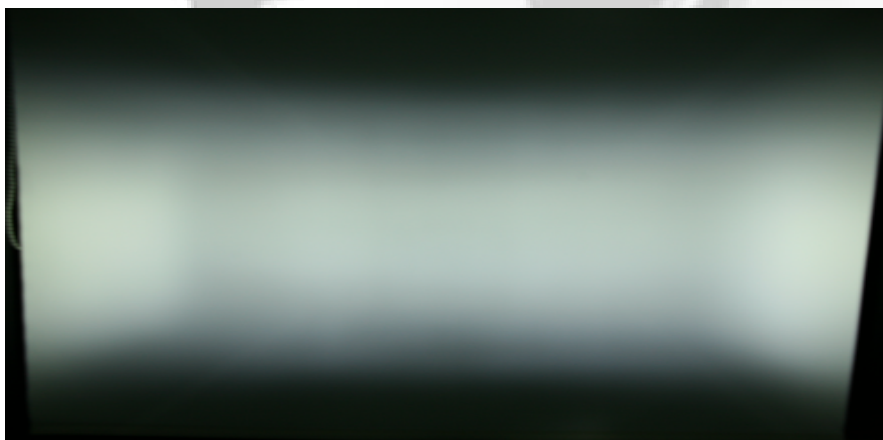

© Ledil Oy – PRELIMINARY - Subject to change without prior notice

MEASUREMENT DATA

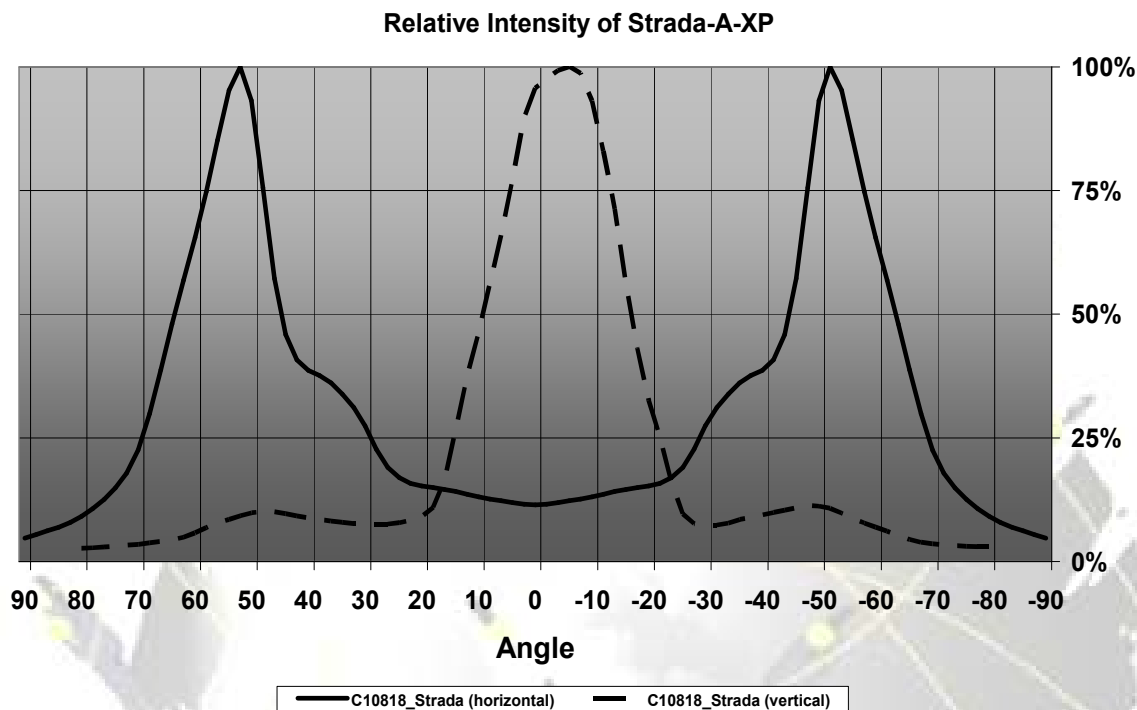

Example configuration (not optimized)

Strada-A-XP

Pole distance: 15m / and single
 Height above the street: 6m
 Position of the lamp from the side of the road: 2.2m
 Tilt angle of the lamp: 10

100x Cree XP's per lamp
 55lm 0.8W (3.2V/250mA)

Length: 0.7m
 Width: 0.3m
 Rows: 5
 LED's per row: 20

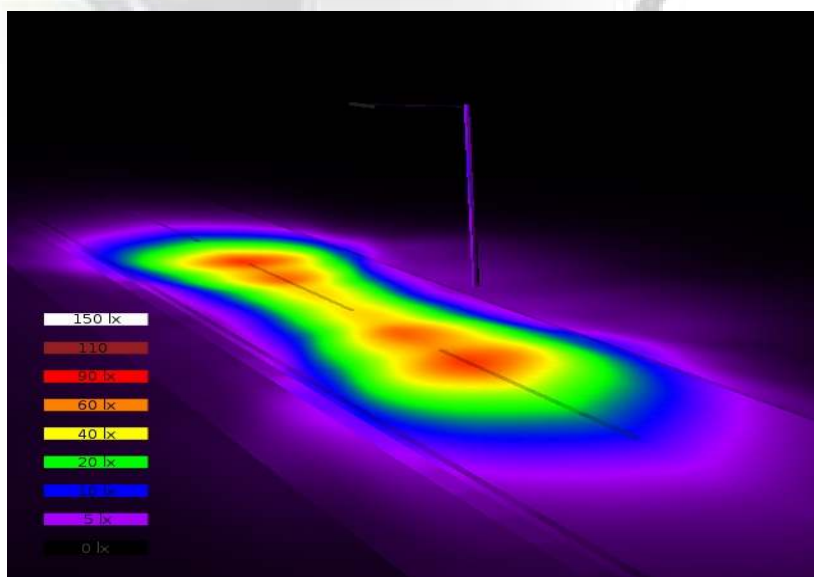

© Ledil Oy – PRELIMINARY - Subject to change without prior notice

DRAWINGS

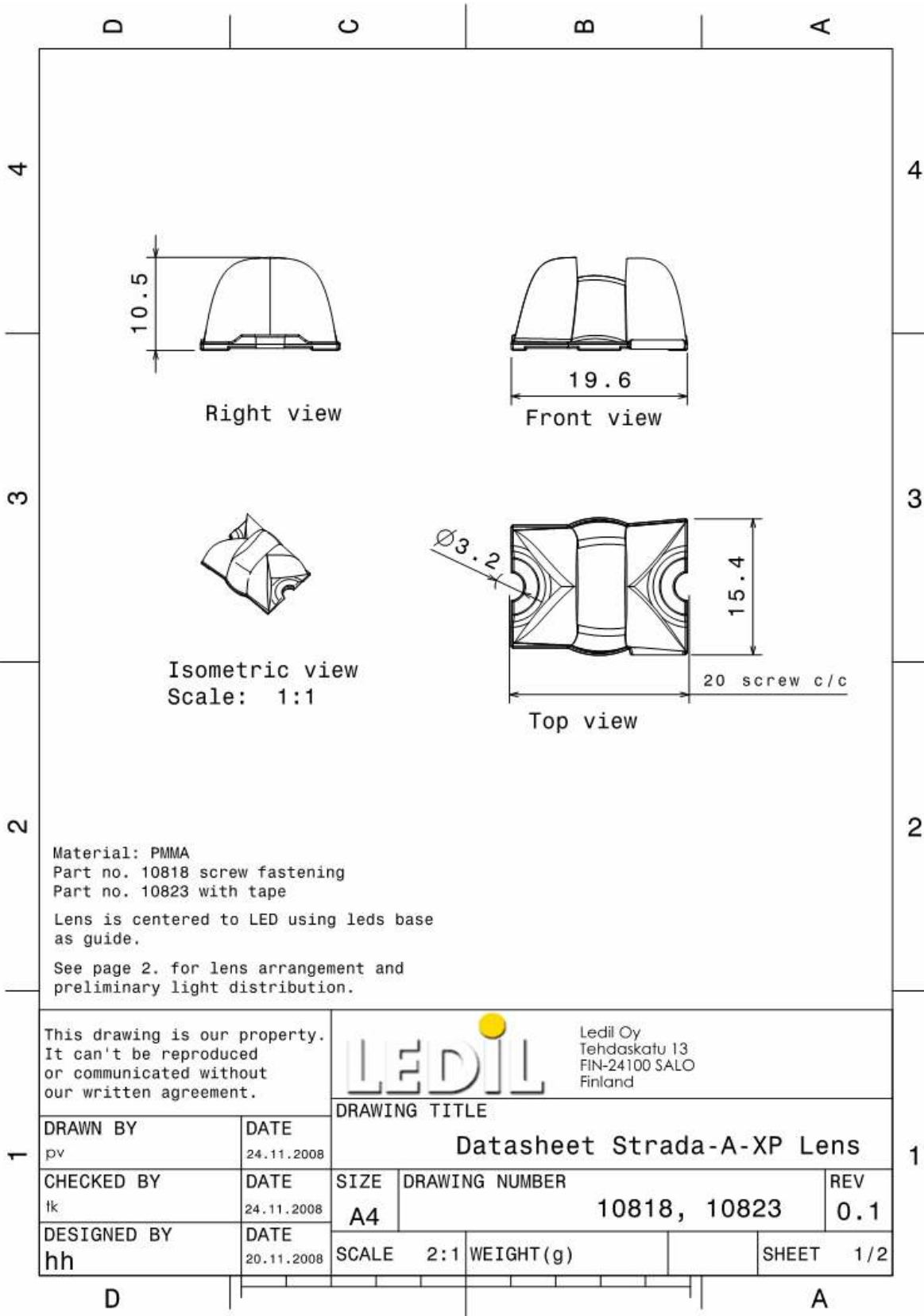

© Ledil Oy - PRELIMINARY - Subject to change without prior notice

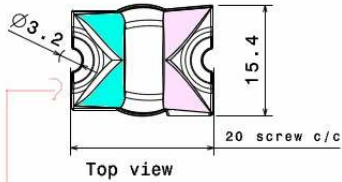
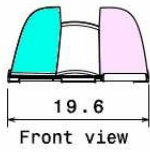

to tilt the light correctly to street,
put the narrower side against the
end side of the street

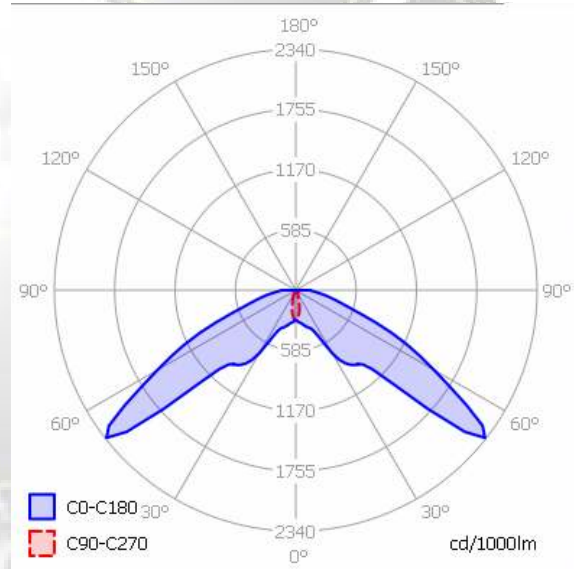
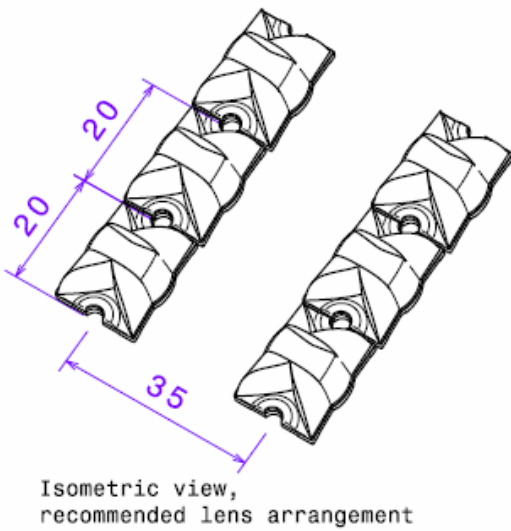
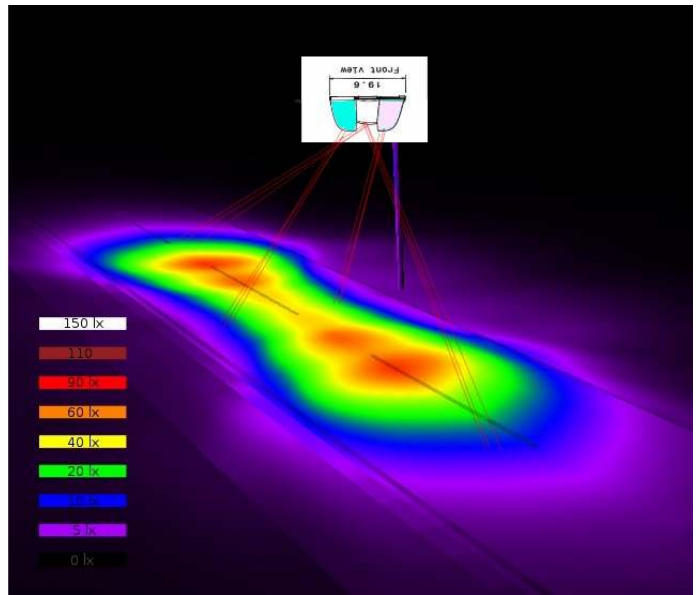

EULUMDAT & IES FILES AVAILABLE BY REQUEST