

Description:

This P-Channel MOSFET uses advanced trench technology and design to provide excellent $R_{DS(on)}$ with low gate charge. It can be used in a wide variety of applications.

Features:

- 1) $V_{DS}=-60V, I_D=-50A, R_{DS(ON)}<35m\Omega @V_{GS}=-10V$
- 2) Low gate charge.
- 3) Green device available.
- 4) Advanced high cell density trench technology for ultra $R_{DS(ON)}$.
- 5) Excellent package for good heat dissipation.

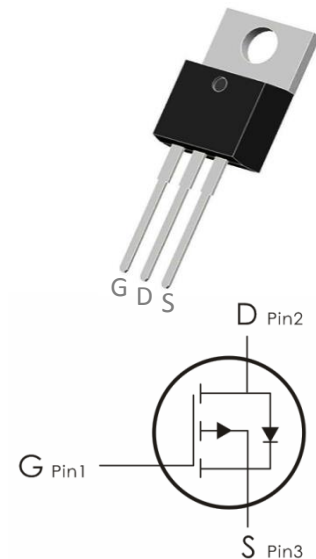

Absolute Maximum Ratings: ($T_C=25^\circ\text{C}$ unless otherwise noted)

Symbol	Parameter	Ratings	Units
V_{DS}	Drain-Source Voltage	-60	V
V_{GS}	Gate-Source Voltage	± 20	V
I_D	Continuous Drain Current-	- 50	A
	Continuous Drain Current- $T_C=100^\circ\text{C}$	-24	
	Pulsed Drain Current ¹	-120	
E_{AR}	Single Pulse Avalanche Energy ³	77	mJ
P_D	Power Dissipation	75	W
T_J, T_{STG}	Operating and Storage Junction Temperature Range	-55 to +150	$^\circ\text{C}$

Thermal Characteristics:

Symbol	Parameter	Max	Units
$R_{\theta JC}$	Thermal Resistance, Junction to Case	1.67	$^\circ\text{C}/\text{W}$

Electrical Characteristics: ($T_C=25^\circ\text{C}$ unless otherwise noted)

Symbol	Parameter	Conditions	Min	Typ	Max	Units
Off Characteristics						
BV_{DSS}	Drain-Source Breakdown Voltage	$V_{GS}=0V, I_D=250\ \mu\text{A}$	-60	---	---	V
I_{DSS}	Zero Gate Voltage Drain Current	$V_{GS}=0V, V_{DS}=-60V$	---	---	-10	μA
I_{GSS}	Gate-Source Leakage Current	$V_{GS}=\pm 20V, V_{DS}=0A$	---	---	± 10	nA
On Characteristics						
$V_{GS(th)}$	GATE-Source Threshold Voltage	$V_{GS}=V_{DS}, I_D=250\ \mu\text{A}$	-1		-2	V
$R_{DS(on)}$	Drain-Source On Resistance ⁴	$V_{GS}=-10V, I_D=-15A$	---	28	35	m Ω
		$V_{GS}=-4V, I_D=-15A$	---	38	55	
Dynamic Characteristics						
C_{iss}	Input Capacitance	$V_{DS}=-10V, V_{GS}=0V, f=1\text{MHz}$	---	2500	---	pF
C_{oss}	Output Capacitance		---	1300	---	
C_{rss}	Reverse Transfer Capacitance		---	300	---	
Switching Characteristics						
$t_{d(on)}$	Turn-On Delay Time	$V_{DD}=-0V, I_D=-15A,$ $R_L=2\ \Omega, V_{GS}=-10V$	---	25	---	ns
t_r	Rise Time		---	150	---	ns
$t_{d(off)}$	Turn-Off Delay Time		---	350	---	ns
t_f	Fall Time		---	220	---	ns
Q_g	Total Gate Charge	$V_{GS}=-10V, V_{DS}=-50V,$ $I_D=-10A$	---	25	---	nC
Q_{gs}	Gate-Source Charge		---	5	---	nC
Q_{gd}	Gate-Drain "Miller" Charge		---	7	---	nC
Drain-Source Diode Characteristics						
T_{rr}	Reverse Recovery Time		---	35	---	nS

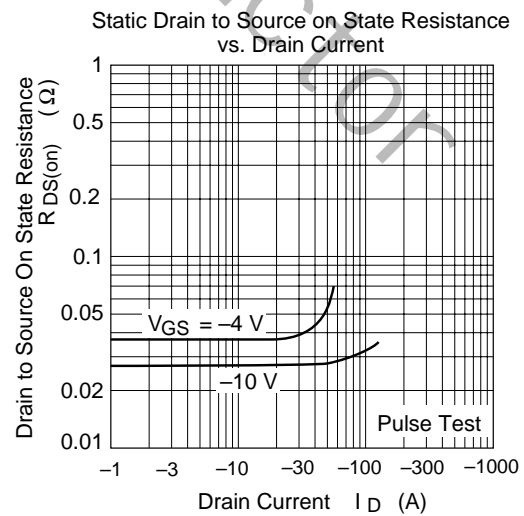
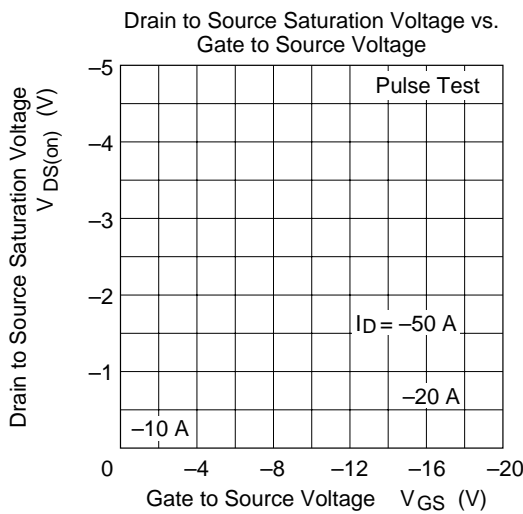
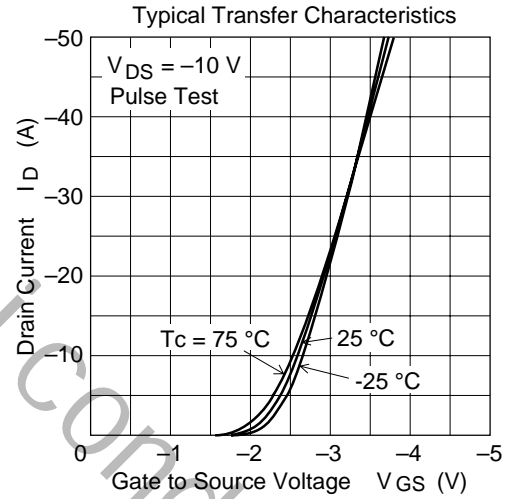
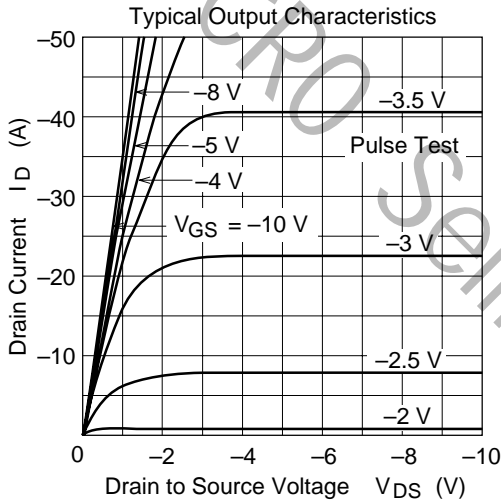
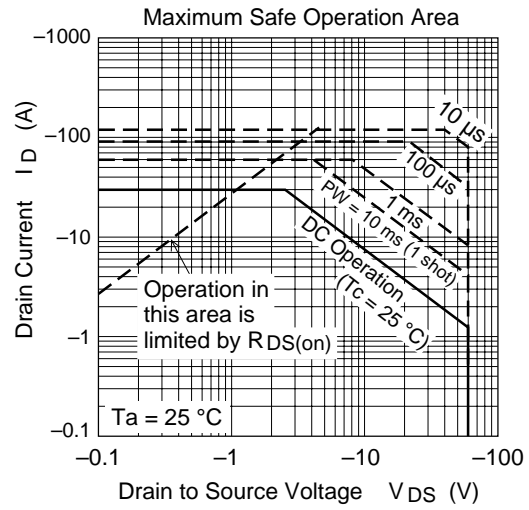
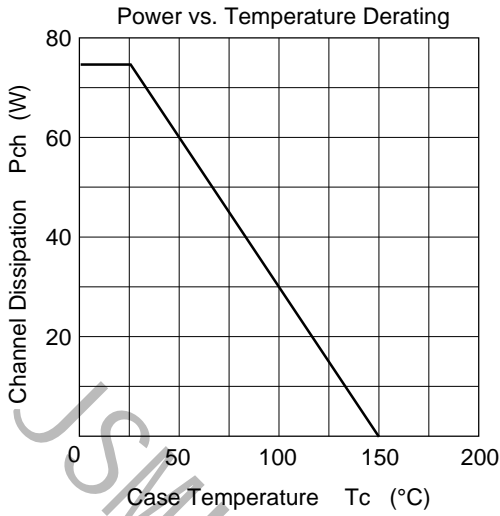
Typical Characteristics: ($T_c=25^\circ\text{C}$ unless otherwise noted)

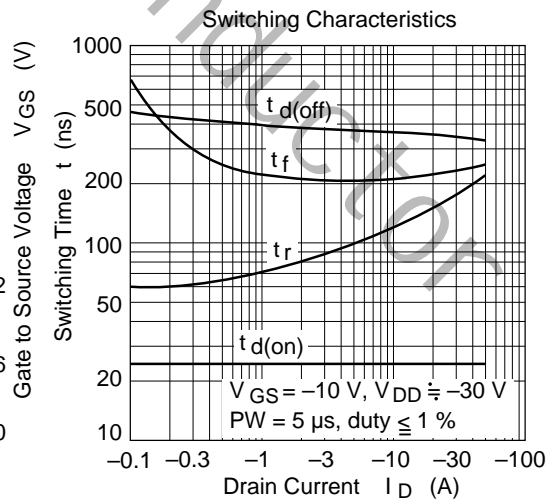
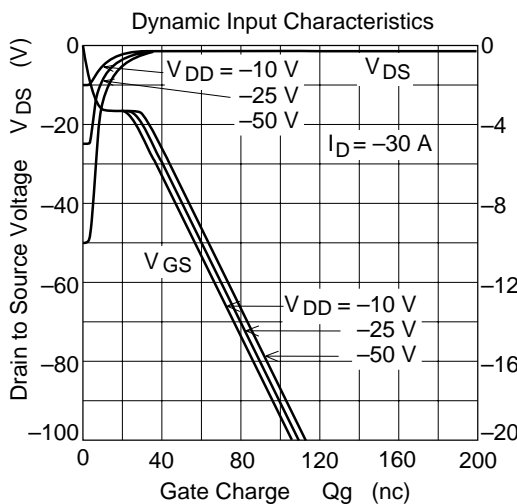
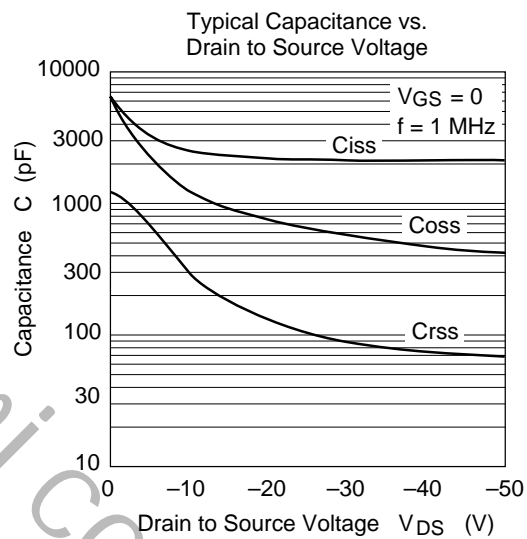
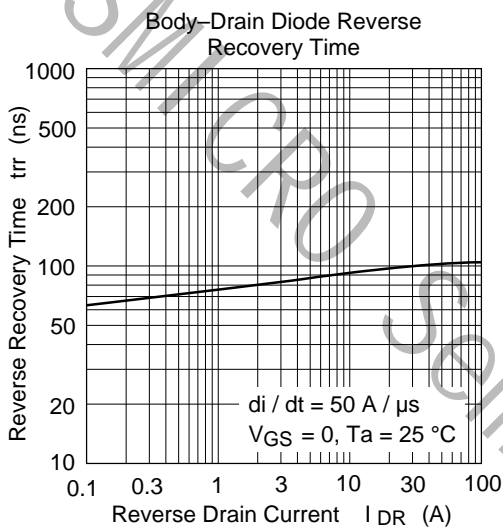
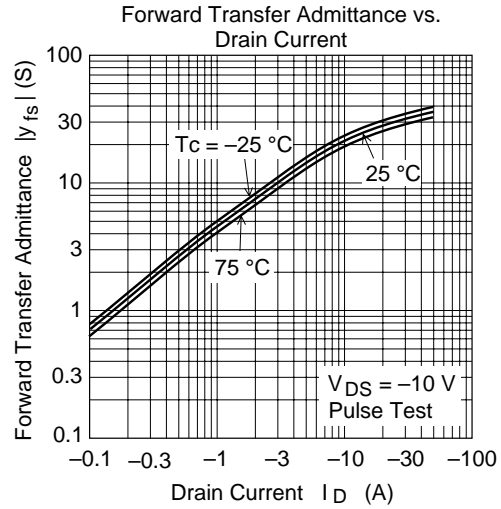
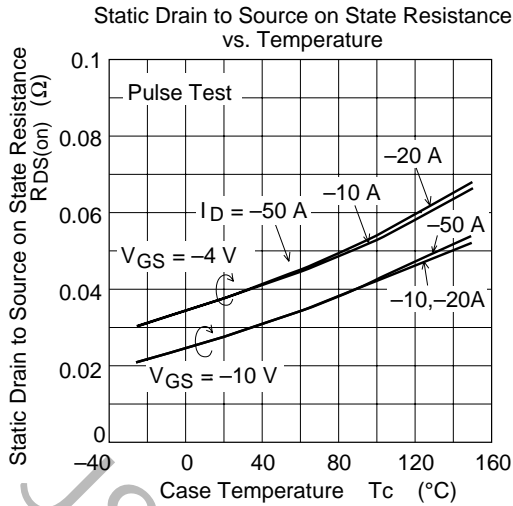

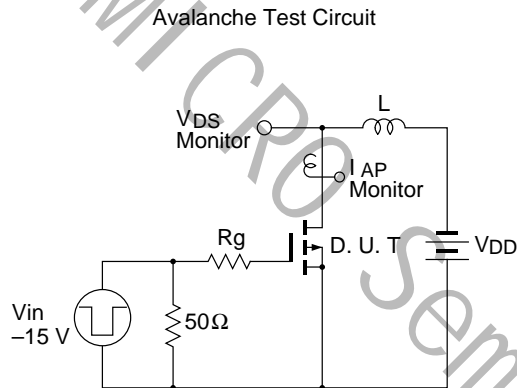
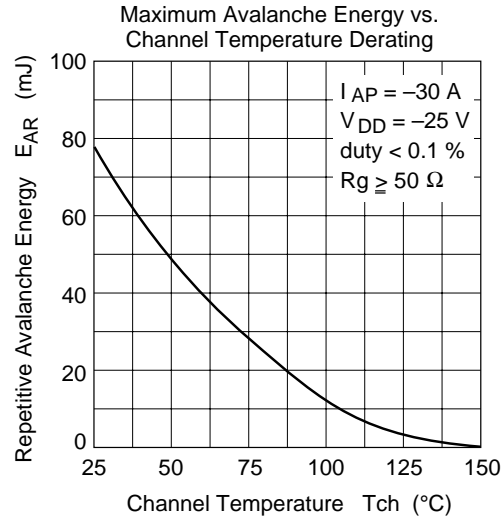
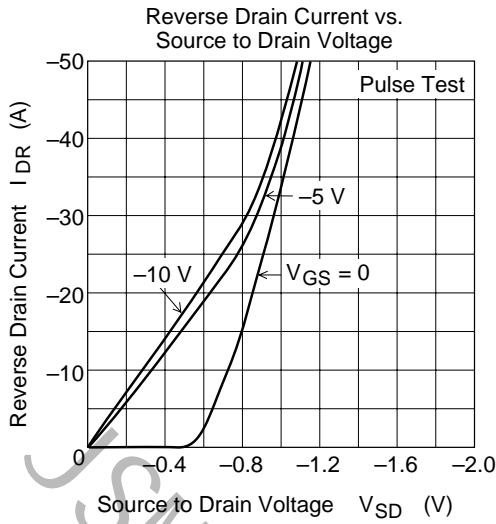

Avalanche Waveform

$$E_{AR} = \frac{1}{2} \cdot L \cdot I_{AP}^2 \cdot \frac{V_{DSS}}{V_{DSS} - V_{DD}}$$

