

## SM712 Series 600W Asymmetrical TVS Diode Array



### Description

The SM712 TVS Diode Array is designed to protect RS-485 applications with asymmetrical working voltages (-7V to 12V) from damage due to electrostatic discharge (ESD), electrical fast transients (EFT), and lightning induced surges.

The SM712 can absorb repetitive ESD strikes above the maximum level specified in the IEC 61000-4-2 international standard without performance degradation and safely dissipate up to 19A of 8/20us induced surge current (IEC-61000-4-5 2nd edition) with very low clamping voltages.

### Pinout and Functional Block Diagram

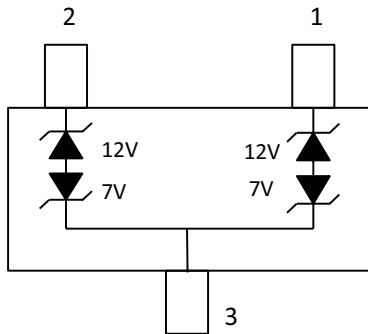

Life Support Note:

**Not Intended for Use in Life Support or Life Saving Applications**

The products shown herein are not designed for use in life sustaining or life saving applications unless otherwise expressly indicated.

### Features

- RoHS compliant and lead-free
- ESD, IEC 61000-4-2, ±30kV contact, ±30kV air
- EFT, IEC 61000-4-4, 50A (5/50ns)
- Lightning, IEC 61000-4-5 2nd edition, 19A ( $t_p=8/20\mu s$ )
- Working Voltages: -7V to 12V
- Low clamping voltage
- Low leakage current
- AEC-Q101 Qualified
- Moisture Sensitivity Level (MSL:1)

### Applications

- RS-485
- Fieldbus
- Modbus
- Profibus
- DMX512
- Security Systems
- Automated Teller Machines (ATMs)
- Lighting Control - DALI
- Communication Equipments

### Additional Information



Datasheet



Resources



Samples

### RS-485 Application Example

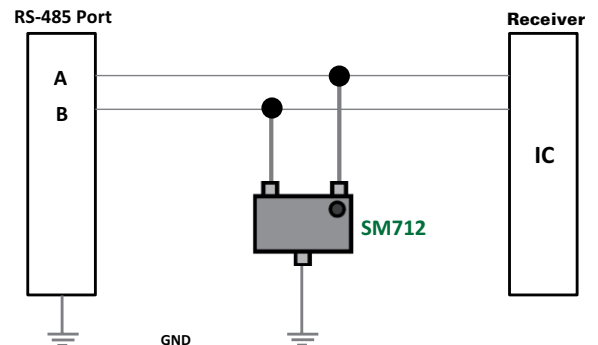

### Absolute Maximum Ratings

Symbol	Parameter	Value	Units
$P_{PK}$	Peak Pulse Power ( $t_p=8/20\mu s$ )	600	W
$I_{PP}$	Peak Pulse Current ( $t_p=8/20\mu s$ )	19	A
$T_{OP}$	Operating Temperature	-40 to 125	°C
$T_{STOR}$	Storage Temperature	-55 to 150	°C

Notes:  
**CAUTION:** Stresses above those listed in "Absolute Maximum Ratings" may cause permanent damage to the component. This is a stress only rating and operation of the component at these or any other conditions above those indicated in the operational sections of this specification is not implied.

### SM712 Electrical Characteristics ( $T_{OP}=25^\circ C$ )

Parameter	Symbol	Test Conditions	Min	Typ	Max	Units
Reverse Standoff Voltage	$V_{RWM}$	$I_R \leq 1\mu A$ , Pin 3 to Pin 1 or Pin 2			7.0	V
		$I_R \leq 1\mu A$ , Pin 1 or Pin 2 to Pin 3			12.0	V
Reverse Breakdown Voltage	$V_R$	$I_R = 1mA$ , Pin 3 to Pin 1 or Pin 2	7.5			V
		$I_R = 1mA$ , Pin 1 or Pin 2 to Pin 3	13.3			V
Leakage Current	$I_{LEAK}$	$V_R = 7V$			20	$\mu A$
		$V_R = 12V$			1	$\mu A$
Clamp Voltage <sup>1</sup>	$V_C$	$I_{PP} = 1A$ , $t_p = 8/20\mu s$ , Pin 1 or Pin 2 to Pin 3			19	V
		$I_{PP} = 1A$ , $t_p = 8/20\mu s$ , Pin 3 to Pin 1 or Pin 2			11	V
		$I_{PP} = 19A$ , $t_p = 8/20\mu s$ , Pin 1 or Pin 2 to Pin 3			31	V
		$I_{PP} = 19A$ , $t_p = 8/20\mu s$ , Pin 3 to Pin 1 or Pin 2			19	V
Dynamic Resistance <sup>1</sup>	$R_{DYN}$	$(V_{C2} - V_{C1}) / (I_{PP2} - I_{PP1})$		0.5		$\Omega$
ESD Withstand Voltage <sup>1</sup>	$V_{ESD}$	IEC 61000-4-2 (Contact Discharge)	$\pm 30$			kV
		IEC 61000-4-2 (Air Discharge)	$\pm 30$			kV
Diode Capacitance <sup>1</sup>	$C_{I/O-GND}$	Reverse Bias=0V, f=1MHz; Pin 1 or Pin 2 to Pin 3			75	pF

Notes : 1. Parameter is guaranteed by design and/or device characterization.

### Capacitance vs. Reverse Bias

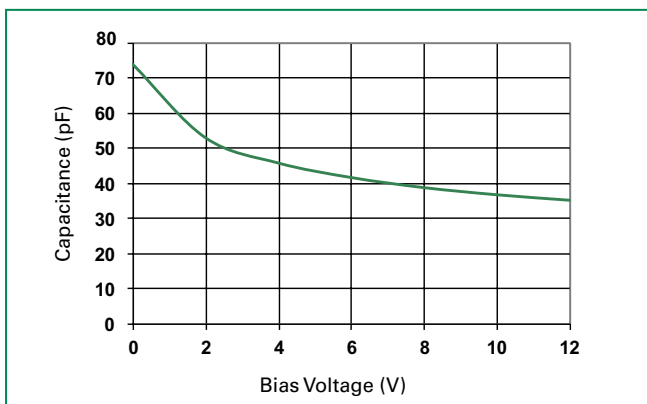

### Clamping Voltage vs. $I_{PP}$

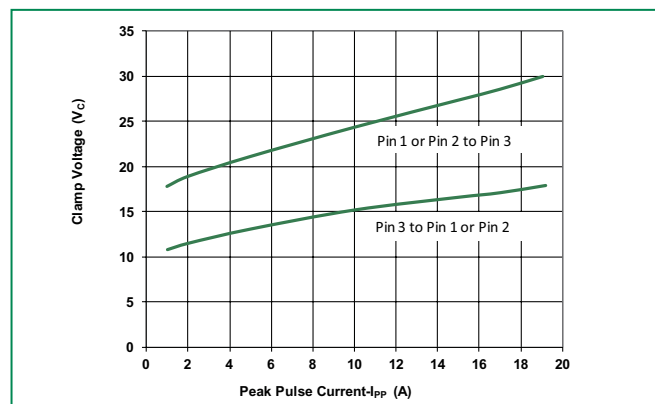

**Non-Repetitive Peak Pulse Power vs. Pulse Time**

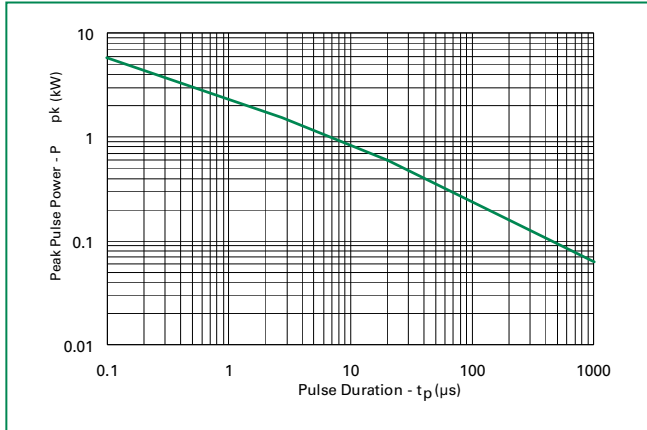

**Power Derating Curve**

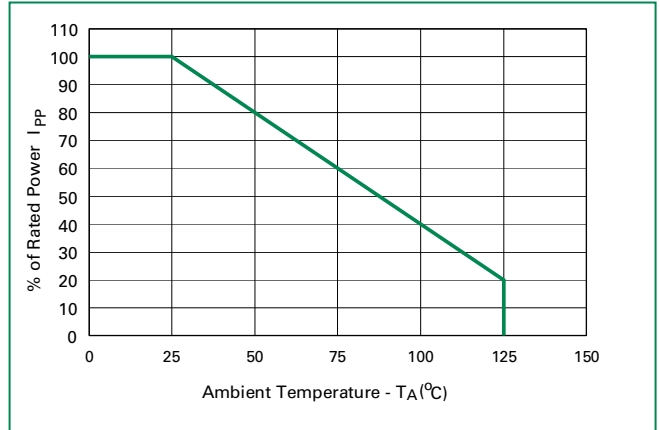

**Pulse Waveform**

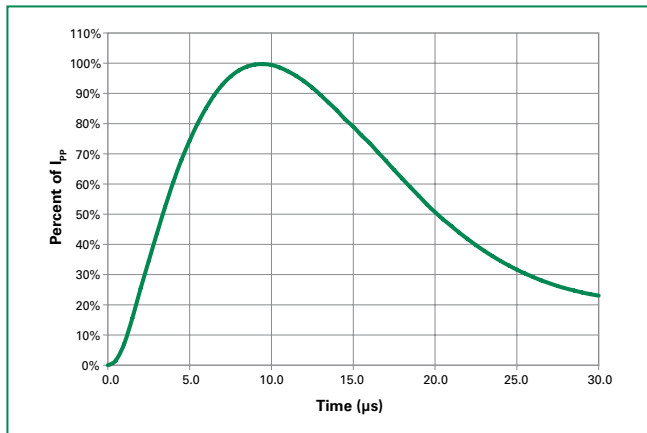

**Soldering Parameters**

Reflow Condition		Pb – Free assembly
Pre Heat	- Temperature Min ( $T_{s(min)}$ )	150°C
	- Temperature Max ( $T_{s(max)}$ )	200°C
	- Time (min to max) ( $t_s$ )	60 – 180 secs
Average ramp up rate (Liquidus) Temp ( $T_L$ ) to peak		3°C/second max
$T_{s(max)}$ to $T_L$ - Ramp-up Rate		3°C/second max
Reflow	- Temperature ( $T_L$ ) (Liquidus)	217°C
	- Temperature ( $t_L$ )	60 – 150 seconds
Peak Temperature ( $T_p$ )		260 <sup>+0/-5</sup> °C
Time within 5°C of actual peak Temperature ( $t_p$ )		20 – 40 seconds
Ramp-down Rate		6°C/second max
Time 25°C to peak Temperature ( $T_p$ )		8 minutes Max.
Do not exceed		260°C

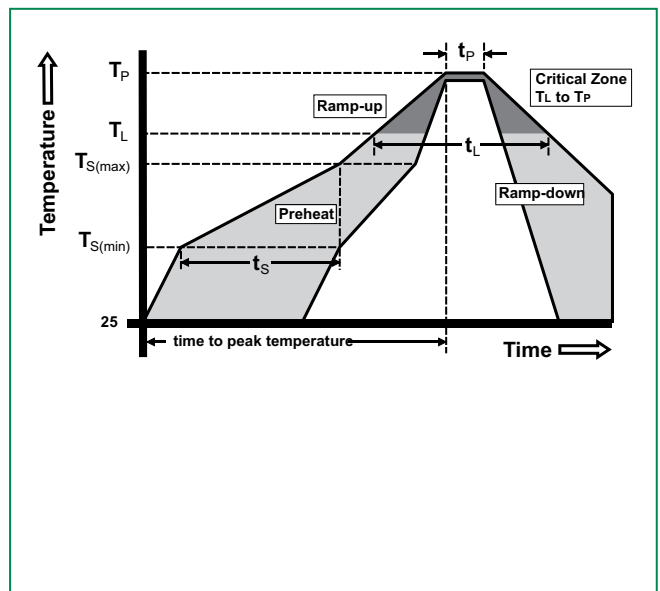

**Part Marking System**

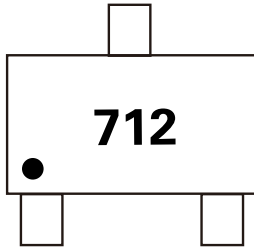

**Part Numbering System**

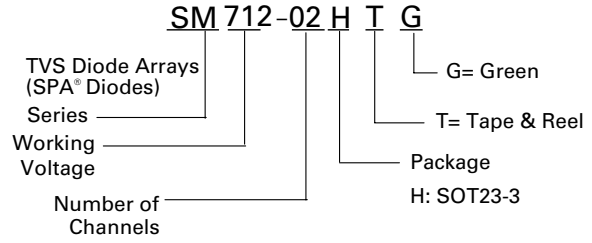

**Ordering Information**

Part Number	Package	Marking	Min. Order Qty.
SM712-02HTG	SOT23-3	712	3000

**Package Dimensions — SOT23-3**

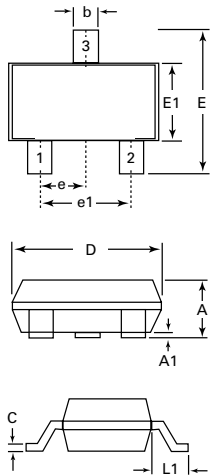

Recommended Pad Layout

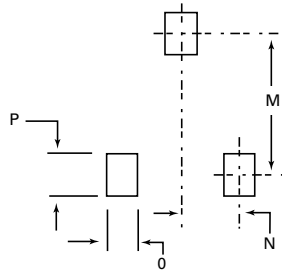

Package	SOT23-3			
Pins	3			
JEDEC	TO-236			
	Millimeters		Inches	
	Min	Max	Min	Max
<b>A</b>	0.89	1.12	0.035	0.044
<b>A1</b>	0.01	0.1	0.0004	0.004
<b>b</b>	0.3	0.5	0.012	0.020
<b>c</b>	0.08	0.2	0.003	0.008
<b>D</b>	2.8	3.04	0.110	0.120
<b>E</b>	2.1	2.64	0.083	0.104
<b>E1</b>	1.2	1.4	0.047	0.055
<b>e</b>	0.95 BSC		0.038 BSC	
<b>e1</b>	1.90 BSC		0.075 BSC	
<b>L1</b>	0.54 REF		0.021 REF	
<b>M</b>	-	2.29	-	.090
<b>N</b>	-	0.95	-	0.038
<b>O</b>	-	0.78	-	.030TYP
<b>P</b>	-	0.78	-	.030TYP

**Embossed Carrier Tape & Reel Specification – SOT23-3**

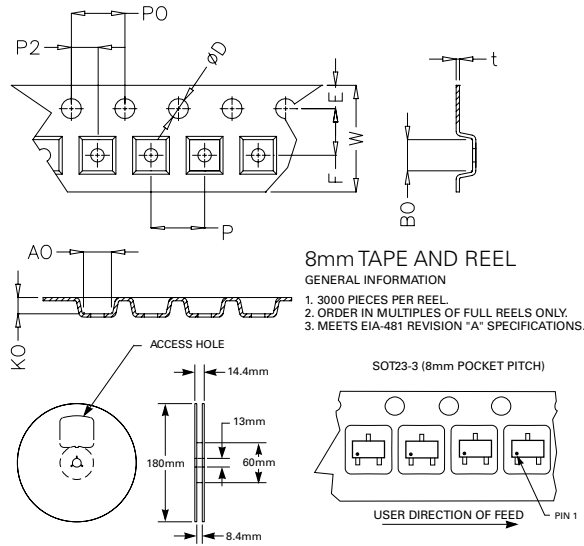

Symbol	Millimetres		Inches	
	Min	Max	Min	Max
<b>E</b>	1.65	1.85	0.065	0.073
<b>F</b>	3.40	3.60	0.134	0.142
<b>P2</b>	1.90	2.10	0.075	0.083
<b>D</b>	1.40	1.60	0.055	0.063
<b>P0</b>	3.90	4.10	0.154	0.161
<b>W</b>	7.70	8.30	0.303	0.327
<b>P</b>	3.90	4.10	0.154	0.161
<b>A0</b>	3.05	3.25	0.120	0.128
<b>B0</b>	2.67	2.87	0.105	0.113
<b>K0</b>	1.12	1.32	0.044	0.052
<b>t</b>	0.22	0.24	0.009	0.009

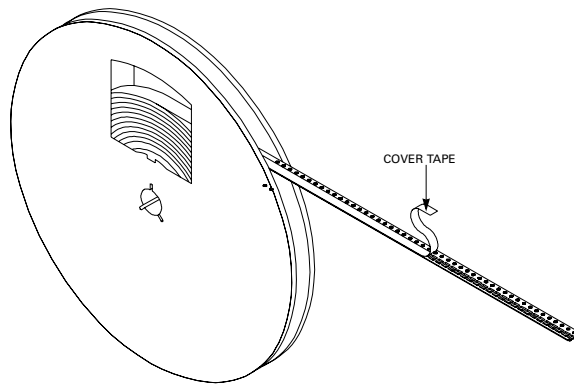

**Disclaimer Notice - Information furnished is believed to be accurate and reliable. However, users should independently evaluate the suitability of and test each product selected for their own applications. Littelfuse products are not designed for, and may not be used in, all applications. Read complete Disclaimer Notice at [www.littelfuse.com/disclaimer-electronics](http://www.littelfuse.com/disclaimer-electronics).**