

HEXFET® Power MOSFET

- Surface Mount
- Available in Tape & Reel
- Dynamic dv/dt Rating
- Repetitive Avalanche Rated
- Logic-Level Gate Drive
- RDS(on) Specified at VGS = 4V & 5V
- Fast Switching

Description

Third Generation HEXFETs from International Rectifier provide the designer with the best combination of fast switching, ruggedized device design, low on-resistance and cost-effectiveness.

The SOT-223 package is designed for surface-mount using vapor phase, infra red, or wave soldering techniques. Its unique package design allows for easy automatic pick-and-place as with other SOT or SOIC packages but has the added advantage of improved thermal performance due to an enlarged tab for heatsinking. Power dissipation of greater than 1.25W is possible in a typical surface mount application.

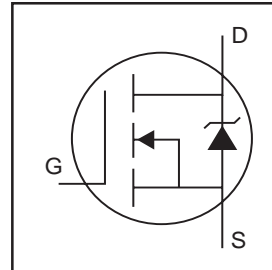

$V_{DSS} = 100V$
 $R_{DS(on)} = 0.54\Omega$
 $I_D = 1.5A$

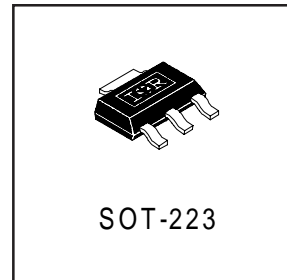

Absolute Maximum Ratings

	Parameter	Max.	Units
I_D @ $T_C = 25^\circ C$	Continuous Drain Current, V_{GS} @ 5.0 V	1.5	A
I_D @ $T_C = 100^\circ C$	Continuous Drain Current, V_{GS} @ 5.0 V	0.93	
I_{DM}	Pulsed Drain Current ①	12	
P_D @ $T_C = 25^\circ C$	Power Dissipation	3.1	W
P_D @ $T_A = 25^\circ C$	Power Dissipation (PCB Mount)**	2.0	
	Linear Derating Factor	0.025	W/°C
	Linear Derating Factor (PCB Mount)**	0.017	
V_{GS}	Gate-to-Source Voltage	-/+10	V
E_{AS}	Single Pulse Avalanche Energy ②	50	mJ
I_{AR}	Avalanche Current ①	1.5	A
E_{AR}	Repetitive Avalanche Energy ①	0.31	mJ
dv/dt	Peak Diode Recovery dv/dt ③	5.5	V/ns
T_J, T_{STG}	Junction and Storage Temperature Range	-55 to +150	°C
	Soldewring Temperature, for 10 seconds	300 (1.6mm from case)	

Thermal Resistance

	Parameter	Typ.	Max.	Units
$R_{\theta JC}$	Junction-to-PCB	—	40	°C/W
$R_{\theta JA}$	Junction-to-Ambient. (PCB Mount)**	—	60	

** When mounted on 1" square PCB (FR-4 or G-10 Material).

For recommended footprint and soldering techniques refer to application note #AN-994.

Electrical Characteristics @ $T_J = 25^\circ\text{C}$ (unless otherwise specified)

	Parameter	Min.	Typ.	Max.	Units	Conditions
$V_{(BR)DSS}$	Drain-to-Source Breakdown Voltage	100	—	—	V	$V_{GS} = 0V, I_D = 250\mu A$
$\Delta V_{(BR)DSS}/\Delta T_J$	Breakdown Voltage Temp. Coefficient	—	0.12	—	V/ $^\circ\text{C}$	Reference to $25^\circ\text{C}, I_D = 1\text{mA}$
$R_{DS(on)}$	Static Drain-to-Source On-Resistance	—	—	0.54	Ω	$V_{GS} = 5.0V, I_D = 0.90A$ ④
		—	—	0.76		$V_{GS} = 4.0V, I_D = 0.75A$
$V_{GS(th)}$	Gate Threshold Voltage	1.0	—	2.0	V	$V_{DS} = V_{GS}, I_D = 250\mu A$
g_{fs}	Forward Transconductance	0.57	—	—	S	$V_{DS} = 25V, I_D = 0.90A$
I_{DSS}	Drain-to-Source Leakage Current	—	—	25	μA	$V_{DS} = 100V, V_{GS} = 0V$
		—	—	250		$V_{DS} = 80V, V_{GS} = 0V, T_J = 125^\circ\text{C}$
I_{GSS}	Gate-to-Source Forward Leakage	—	—	100	nA	$V_{GS} = 10V$
	Gate-to-Source Reverse Leakage	—	—	-100		$V_{GS} = -10V$
Q_g	Total Gate Charge	—	—	6.1	nC	$I_D = 5.6A$ $V_{DS} = 80V$ $V_{GS} = 5.0V$, See Fig. 6 and 13 ④
Q_{gs}	Gate-to-Source Charge	—	—	2.6		
Q_{gd}	Gate-to-Drain ("Miller") Charge	—	—	3.3		
$t_{d(on)}$	Turn-On Delay Time	—	9.3	—	ns	$V_{DD} = 50V$ $I_D = 5.6A$ $R_G = 12\Omega$ $R_D = 8.4\Omega$,
t_r	Rise Time	—	47	—		
$t_{d(off)}$	Turn-Off Delay Time	—	16	—		
t_f	Fall Time	—	18	—		
L_D	Internal Drain Inductance	—	4.0	—	nH	Between lead, 6mm(0.25in) from package and center of die contact. 
L_S	Internal Source Inductance	—	6.0	—		
C_{iss}	Input Capacitance	—	250	—	pF	$V_{GS} = 0V$ $V_{DS} = 25V$ $f = 1.0\text{MHz}$, See Fig. 5
C_{oss}	Output Capacitance	—	80	—		
C_{riss}	Reverse Transfer Capacitance	—	15	—		

Source-Drain Ratings and Characteristics

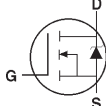
	Parameter	Min.	Typ.	Max.	Units	Conditions
I_S	Continuous Source Current (Body Diode)	—	—	1.5	A	MOSFET symbol showing the integral reverse p-n junction diode. 
I_{SM}	Pulsed Source Current (Body Diode) ①	—	—	12		
V_{SD}	Diode Forward Voltage	—	—	2.5	V	$T_J = 25^\circ\text{C}, I_S = 1.5A, V_{GS} = 0V$ ④
t_{rr}	Reverse Recovery Time	—	110	130	ns	$T_J = 25^\circ\text{C}, I_F = 5.6A$
Q_{rr}	Reverse Recovery Charge	—	0.50	0.65	μC	$di/dt = 100A/\mu s$ ④
t_{on}	Forward Turn-On Time	Intrinsic turn-on time is negligible (turn-on is dominated by L_S+L_D)				

Notes:

① Repetitive rating; pulse width limited by max. junction temperature. (See fig. 11)

② $V_{DD} = 25V$, starting $T_J = 25^\circ\text{C}$, $L = 25\text{mH}$
 $R_G = 25\Omega, I_{AS} = 1.5A$. (See Figure 12)

③ $I_{SD} \leq 5.6A, di/dt \leq 75A/\mu s, V_{DD} \leq V_{(BR)DSS}, T_J \leq 150^\circ\text{C}$

④ Pulse width $\leq 300\mu s$; duty cycle $\leq 2\%$.

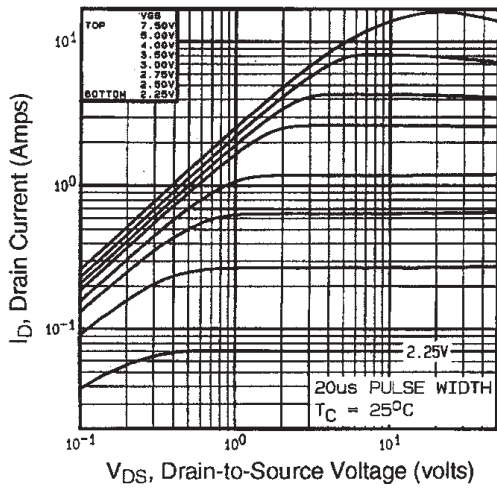

Fig 1. Typical Output Characteristics,

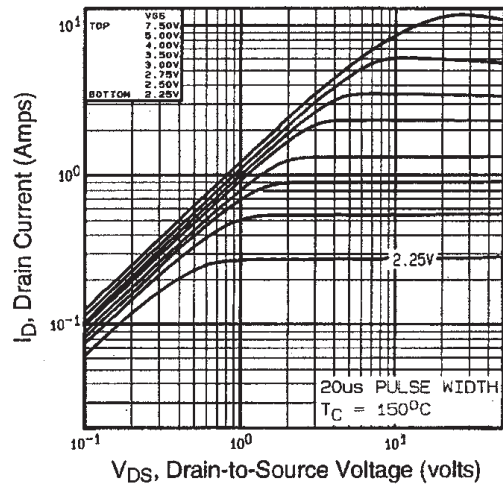

Fig 2. Typical Output Characteristics,

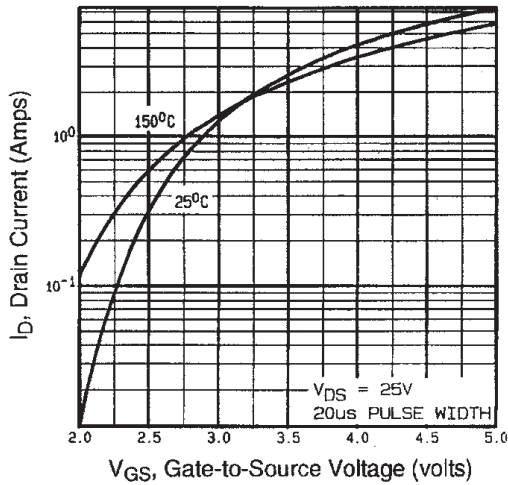

Fig 3. Typical Transfer Characteristics

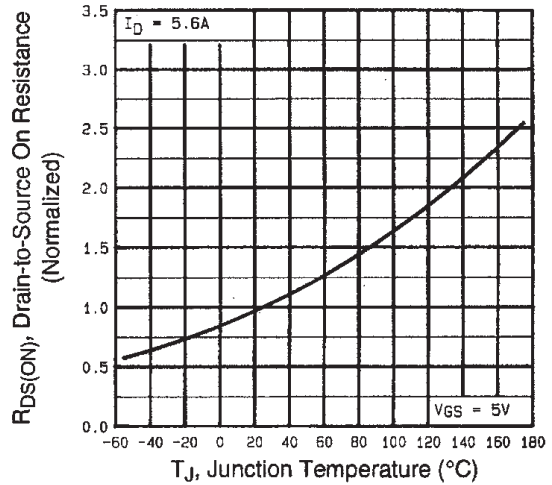

Fig 4. Normalized On-Resistance Vs. Temperature

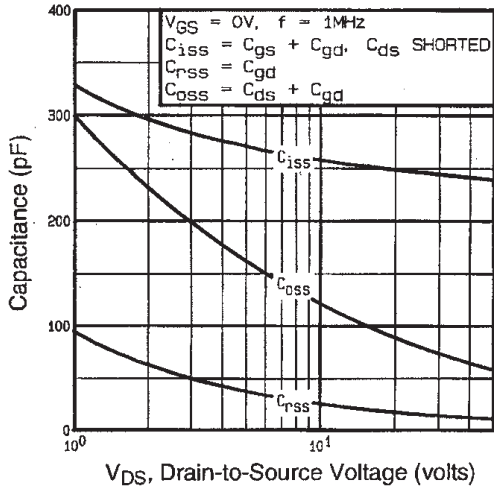

Fig 5. Typical Capacitance Vs. Drain-to-Source Voltage

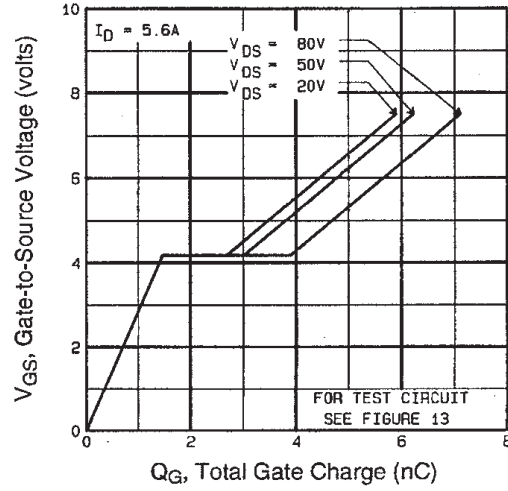

Fig 6. Typical Gate Charge Vs. Gate-to-Source Voltage

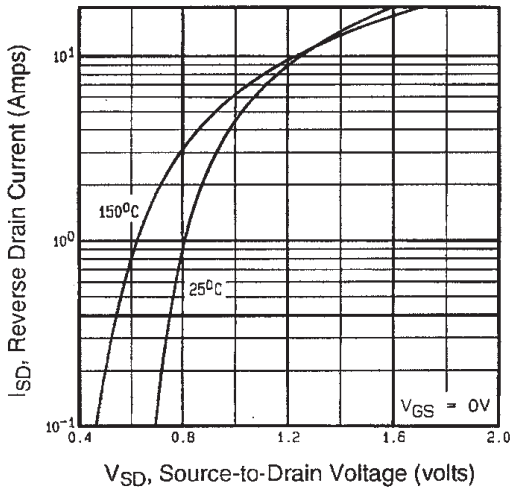

Fig 7. Typical Source-Drain Diode Forward Voltage

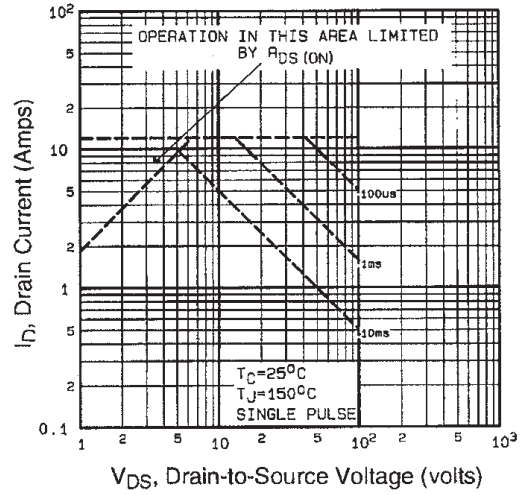

Fig 8. Maximum Safe Operating Area

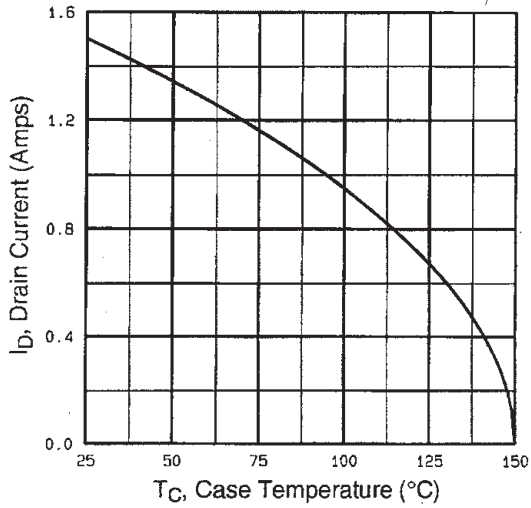

Fig 9. Maximum Drain Current Vs. Case Temperature

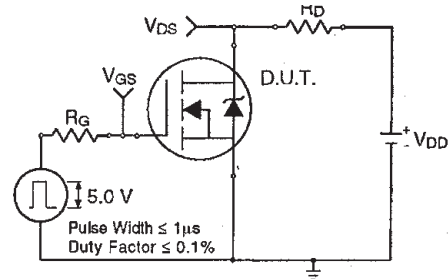

Fig 10a. Switching Time Test Circuit

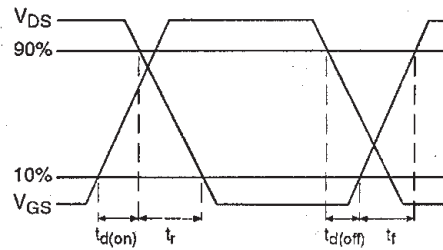

Fig 10b. Switching Time Waveforms

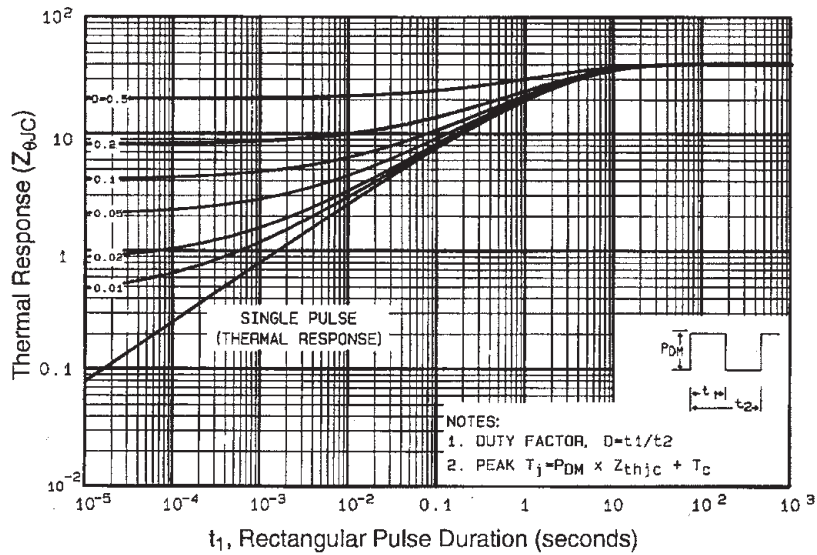

Fig 11. Maximum Effective Transient Thermal Impedance, Junction-to-Case

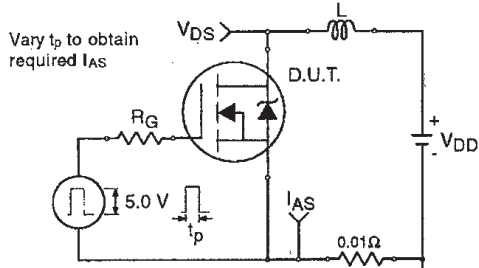

Fig 12a. Unclamped Inductive Test Circuit

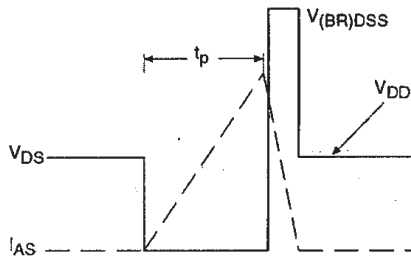

Fig 12b. Unclamped Inductive Waveforms

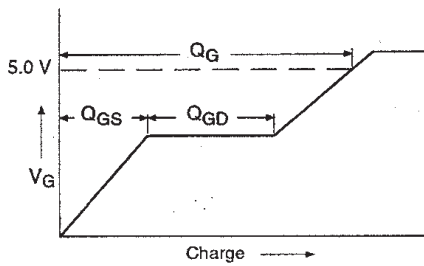

Fig 13a. Basic Gate Charge Waveform

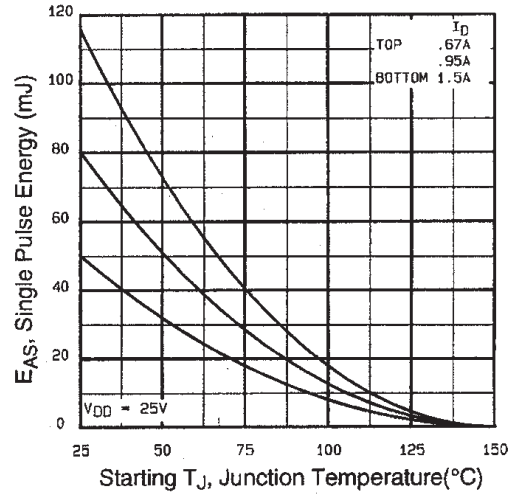

Fig 12c. Maximum Avalanche Energy Vs. Drain Current

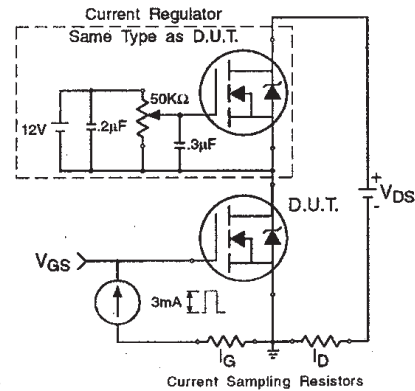
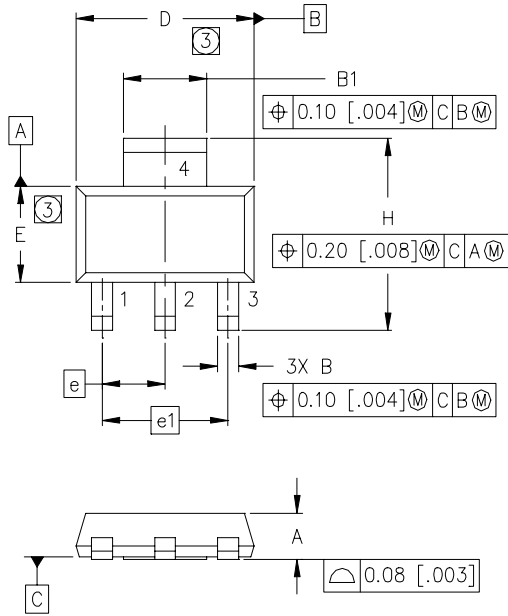

Fig 13b. Gate Charge Test Circuit

International
IR Rectifier
Package Outline
SOT-223 (TO-261AA) Outline

IRLL110



DIM	MILLIMETERS		INCHES	
	MIN	MAX	MIN	MAX
A	1.55	1.80	.061	.071
B	0.65	0.85	.026	.033
B1	2.95	3.15	.116	.124
C	0.25	0.35	.010	.014
D	6.30	6.70	.248	.264
E	3.30	3.70	.130	.146
e	2.30	BSC	.0905	BSC
e1	4.60	BSC	.181	BSC
H	6.71	7.29	.264	.287
L	0.91	—	.036	—
L1	0.061	BSC	.0024	BSC
θ	—	10°	—	10°

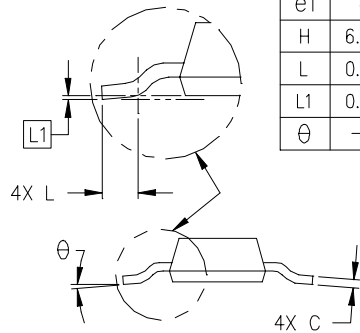

MINIMUM RECOMMENDED FOOTPRINT

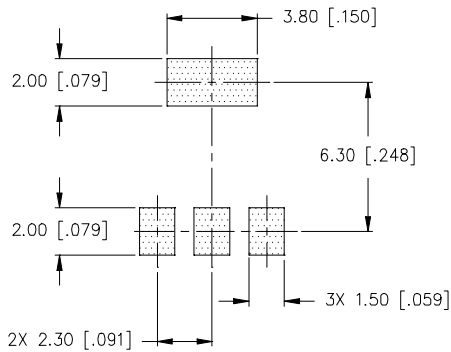

LEAD ASSIGNMENTS

- 1 = GATE
- 2 = DRAIN
- 3 = SOURCE
- 4 = DRAIN

NOTES:

1. DIMENSIONING & TOLERANCING PER ASME Y14.5M-1994.
2. CONTROLLING DIMENSION: INCH.
- ③ DIMENSIONS DO NOT INCLUDE MOLD FLASH.
4. OUTLINE CONFORMS TO JEDEC OUTLINE TO-261AA.
5. DIMENSIONS ARE SHOWN IN MILLIMETERS [INCHES].

Part Marking Information

SOT-223

EXAMPLE : THIS IS AN IRFL014

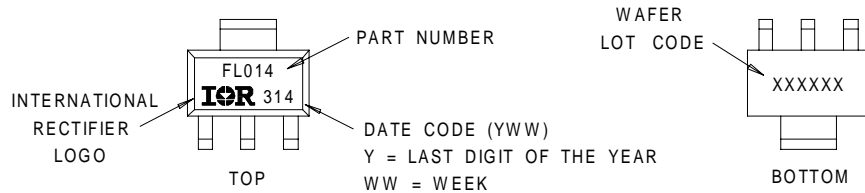

IRLL110

International
IR Rectifier

Tape & Reel Information

SOT-223 Outline

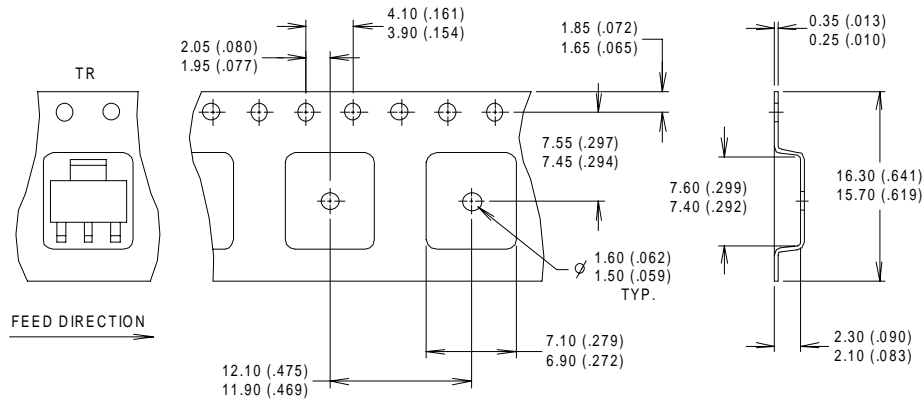

- NOTES :
1. CONTROLLING DIMENSION: MILLIMETER.
 2. OUTLINE CONFORMS TO EIA-481 & EIA-541.
 3. EACH $\varnothing 330.00$ (13.00) REEL CONTAINS 2,500 DEVICES.

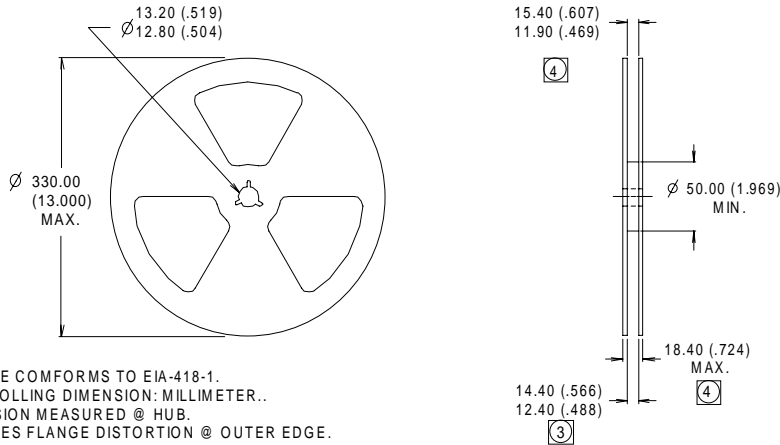

- NOTES :
1. OUTLINE COMFORMS TO EIA-418-1.
 2. CONTROLLING DIMENSION: MILLIMETER..
 - ③ DIMENSION MEASURED @ HUB.
 - ④ INCLUDES FLANGE DISTORTION @ OUTER EDGE.

International
IR Rectifier

WORLD HEADQUARTERS: 233 Kansas St., El Segundo, California 90245, Tel: (310) 322 3331

IR GREAT BRITAIN: Hurst Green, Oxted, Surrey RH8 9BB, UK Tel: ++ 44 1883 732020

IR CANADA: 15 Lincoln Court, Brampton, Ontario L6T3Z2, Tel: (905) 453 2200

IR GERMANY: Saalburgstrasse 157, 61350 Bad Homburg Tel: ++ 49 6172 96590

IR ITALY: Via Liguria 49, 10071 Borgaro, Torino Tel: ++ 39 11 451 0111

IR FAR EAST: K&H Bldg., 2F, 30-4 Nishi-Ikebukuro 3-Chome, Toshima-Ku, Tokyo Japan 171 Tel: 81 3 3983 0086

IR SOUTHEAST ASIA: 1 Kim Seng Promenade, Great World City West Tower, 13-11, Singapore 237994 Tel: ++ 65 838 4630

IR TAIWAN: 16 Fl. Suite D. 207, Sec. 2, Tun Haw South Road, Taipei, 10673, Taiwan Tel: 886-2-2377-9936

<http://www.irf.com/> Data and specifications subject to change without notice. 1/99

This datasheet has been download from:

www.datasheetcatalog.com

Datasheets for electronics components.