

Ultrafast Soft Recovery Diode

Features

- Ultrafast Recovery
- 175°C Operating Junction Temperature
- Screw Mounting Only
- Lead-Free Plating

Benefits

- Reduced RFI and EMI
- Higher Frequency Operation
- Reduced Snubbing
- Reduced Parts Count

$$t_{rr} = 45\text{ns}$$

$$I_{F(AV)} = 150\text{Amp}$$

$$V_R = 200\text{V}$$

Description/ Applications

These diodes are optimized to reduce losses and EMI/ RFI in high frequency power conditioning systems. The softness of the recovery eliminates the need for a snubber in most applications. These devices are ideally suited for HF welding, power converters and other applications where switching losses are not significant portion of the total losses.

Absolute Maximum Ratings

Parameters	Max	Units
V_R Cathode to Anode Voltage	200	V
$I_{F(AV)}$ Continuous Forward Current, $T_C = 116^\circ\text{C}$	150	A
I_{FSM} Single Pulse Forward Current, $T_C = 25^\circ\text{C}$	1600	
$I_{FRM} \text{ } \textcircled{1}$ Maximum Repetitive Forward Current	380	
T_J, T_{STG} Operating Junction and Storage Temperatures	- 55 to 175	$^\circ\text{C}$

$\textcircled{1}$ Square Wave, 20kHz

Case Styles

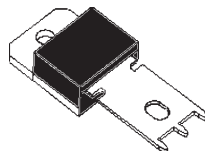

PowIRtab

Electrical Characteristics @ T_J = 25°C (unless otherwise specified)

Parameters	Min	Typ	Max	Units	Test Conditions
V _{BR} , V _r Breakdown Voltage, Blocking Voltage	200	-	-	V	I _R = 100μA
V _F Forward Voltage	-	0.99	1.13	V	I _F = 150A
	-	0.79	0.90	V	I _F = 150A, T _J = 175°C
I _R Reverse Leakage Current	-	-	50	μA	V _R = V _R Rated
	-	-	2	mA	T _J = 150°C, V _R = V _R Rated
C _T Junction Capacitance	-	180	-	pF	V _R = 200V
L _S Series Inductance	-	3.5	-	nH	Measured lead to lead 5mm from package body

Dynamic Recovery Characteristics @ T_J = 25°C (unless otherwise specified)

Parameters	Min	Typ	Max	Units	Test Conditions	
t _{rr} Reverse Recovery Time	-	-	45	ns	I _F = 1.0A, di _F /dt = 200A/μs, V _R = 30V	
	-	34	-		T _J = 25°C	I _F = 150A V _R = 160V di _F /dt = 200A/μs
	-	58	-		T _J = 125°C	
I _{RRM} Peak Recovery Current	-	4.5	-	A	T _J = 25°C	
	-	9.0	-		T _J = 125°C	
Q _{rr} Reverse Recovery Charge	-	87	-	nC	T _J = 25°C	
	-	-	300		-	T _J = 125°C

Thermal - Mechanical Characteristics

Parameters	Min	Typ	Max	Units
R _{thJC} Thermal Resistance, Junction to Case			0.35	K/W
R _{thCS} ② Thermal Resistance, Case to Heatsink		0.2		
Wt Weight			5.02	g
			0.18	(oz)
T Mounting Torque	1.2		2.4	N * m
	10		20	lbf.in

② Mounting Surface, Flat, Smooth and Greased

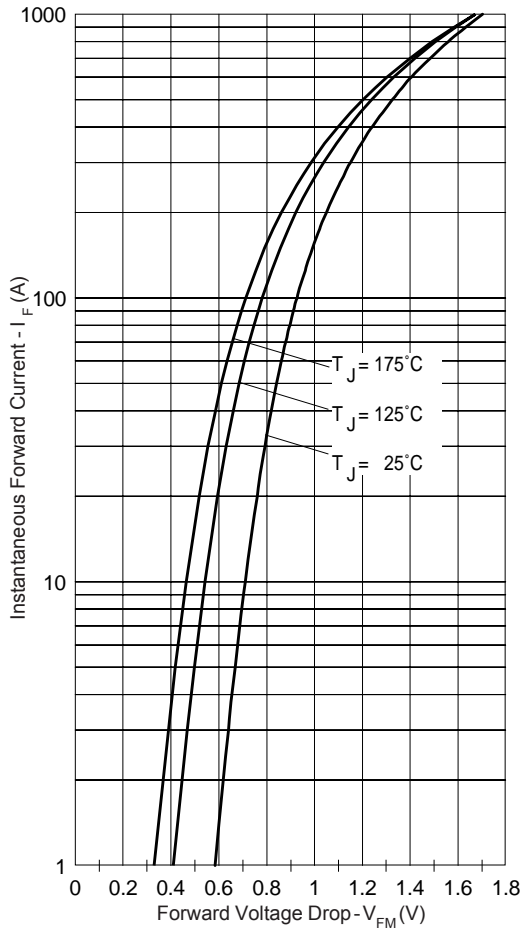

Fig. 1 - Typical Forward Voltage Drop Characteristics

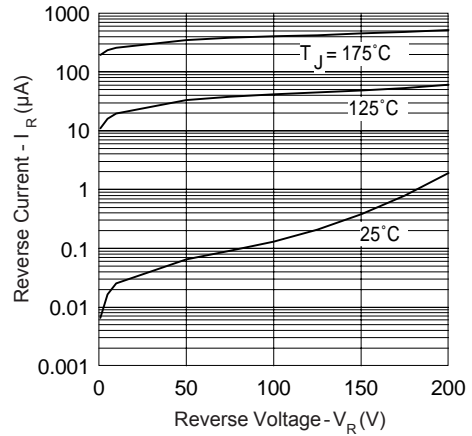

Fig. 2 - Typical Values Of Reverse Current Vs. Reverse Voltage

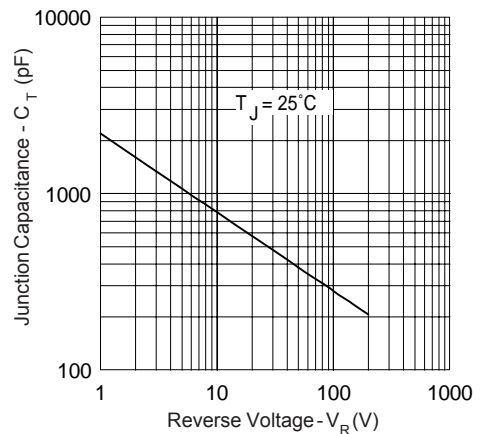

Fig. 3 - Typical Junction Capacitance Vs. Reverse Voltage

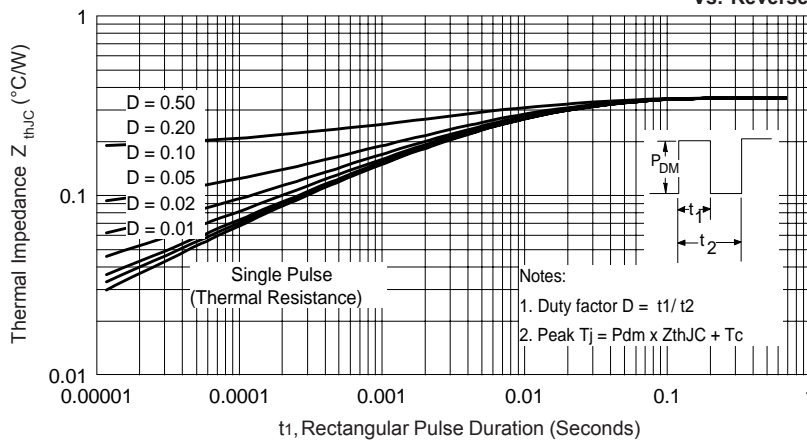

Fig. 4 - Max. Thermal Impedance Z_{thJC} Characteristics

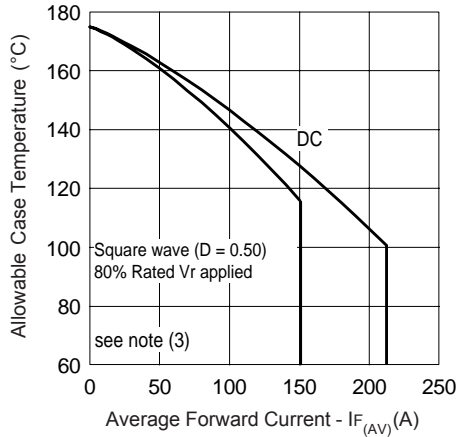

Fig. 5 - Max. Allowable Case Temperature Vs. Average Forward Current

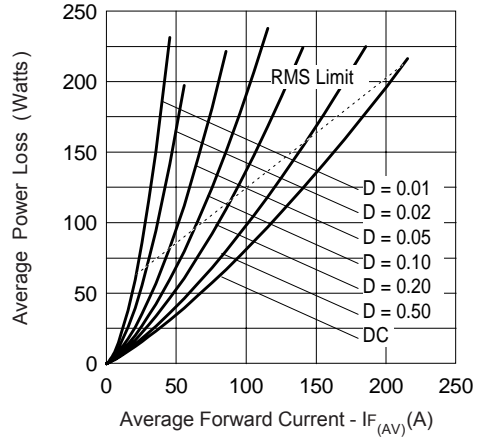

Fig. 6 - Forward Power Loss Characteristics

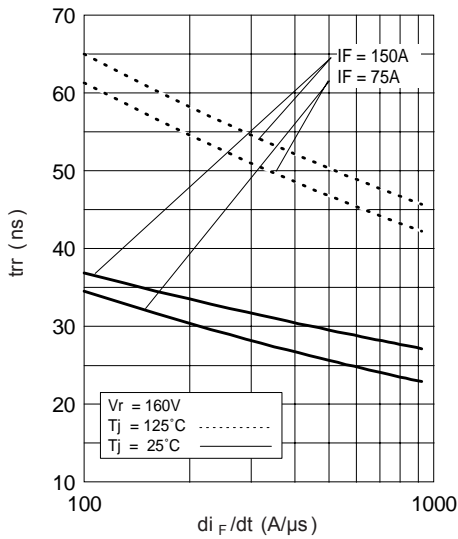

Fig. 7 - Typical Reverse Recovery time vs. di_F/dt

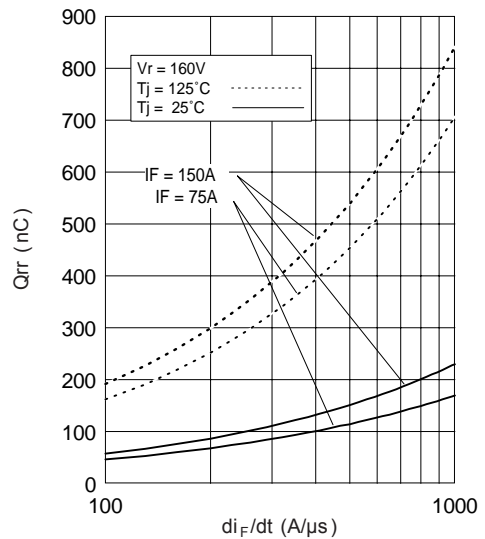

Fig. 8 - Typical Stored Charge vs. di_F/dt

(3) Formula used: $T_c = T_j - (P_d + P_{d_{REV}}) \times R_{thJC}$;
 $P_d = \text{Forward Power Loss} = I_{F(AV)} \times V_{FM} @ (I_{F(AV)} / D)$ (see Fig. 6);
 $P_{d_{REV}} = \text{Inverse Power Loss} = V_{R1} \times I_{R1} (1 - D)$; $I_{R1} @ V_{R1} = 80\% \text{ rated } V_R$

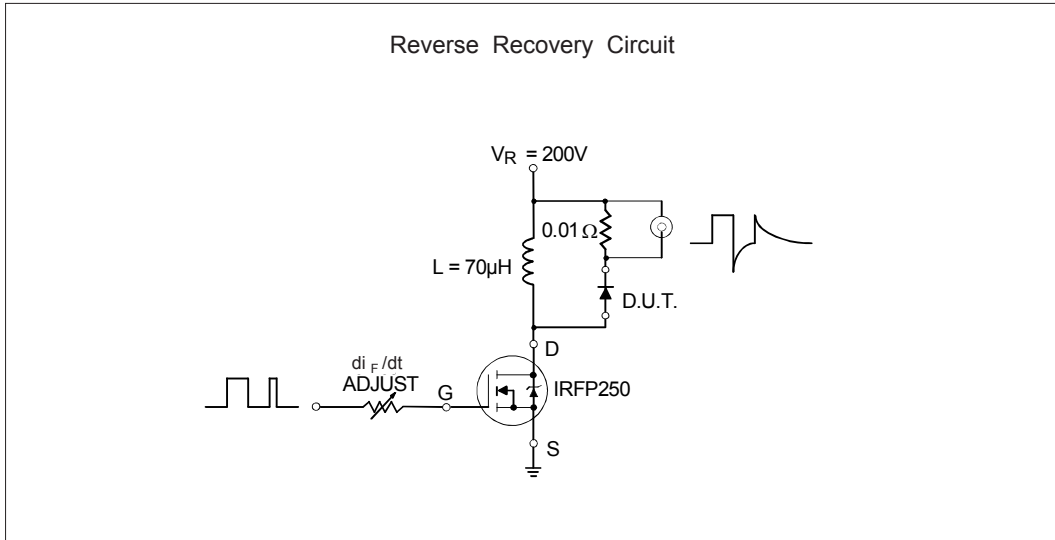

Fig. 9- Reverse Recovery Parameter Test Circuit

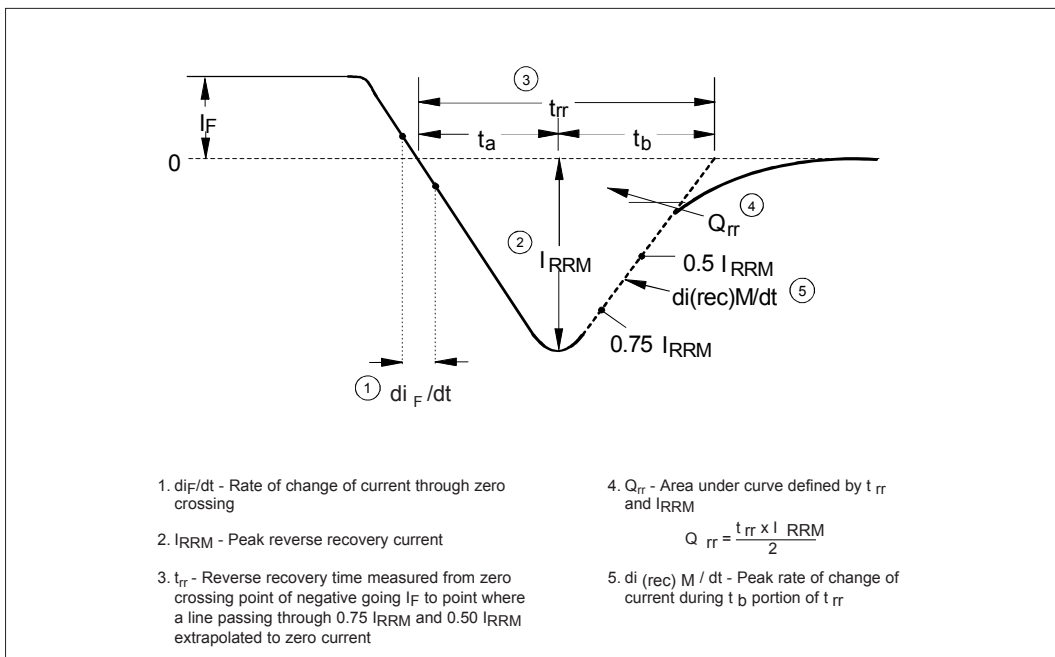
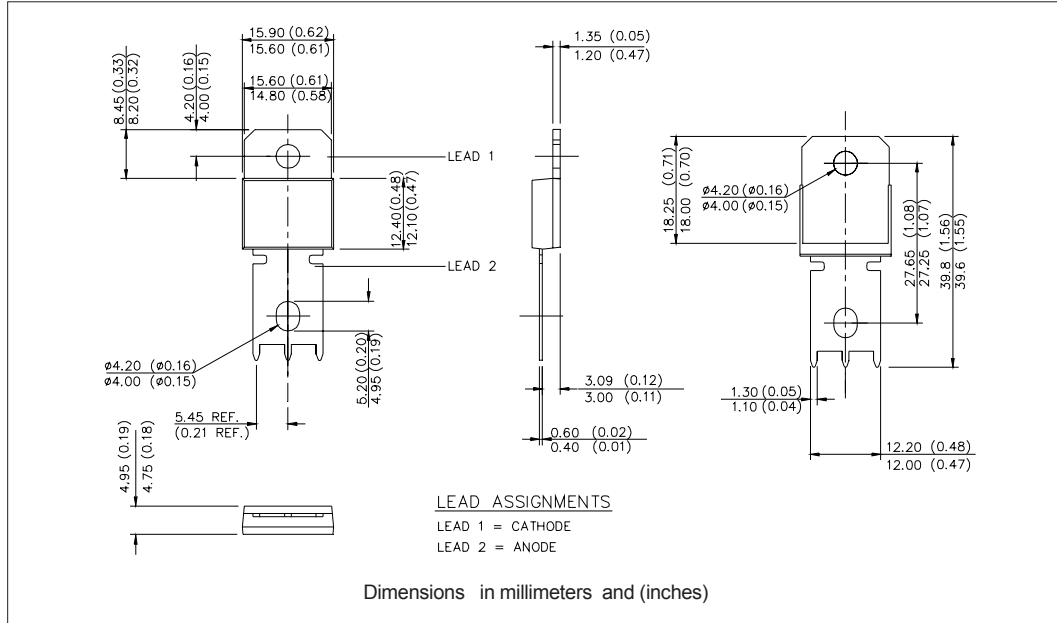

Fig. 10 - Reverse Recovery Waveform and Definitions

Outline Table



Ordering Information Table

Device Code	
150	E B U 02
①	② ③ ④ ⑤
1	- Current Rating (150 = 150A)
2	- Single Diode
3	- Pow <i>IR</i> tab (Ultrafast/ Hyperfast only)
4	- Ultrafast Recovery
5	- Voltage Rating (02 = 200V)

Data and specifications subject to change without notice.
This product has been designed and qualified for Industrial Level and Lead-Free.
Qualification Standards can be found on IR's Web site.