

TOSHIBA Bipolar Digital Integrated Circuit Silicon Monolithic

## ULN2803APG, ULN2803AFWG, ULN2804APG, ULN2804AFWG (Manufactured by Toshiba Malaysia)

### 8ch Darlington Sink Driver

The ULN2803APG / AFWG Series are high-voltage, high-current darlington drivers comprised of eight NPN darlington pairs. All units feature integral clamp diodes for switching inductive loads. Applications include relay, hammer, lamp and display (LED) drivers. The suffix (G) appended to the part number represents a Lead (Pb)-Free product.

### Features

- Output current (single output)  
500 mA (Max.)
- High sustaining voltage output  
50 V (Min.)
- Output clamp diodes
- Inputs compatible with various types of logic.
- Package Type-APG : DIP-18pin
- Package Type-AFWG : SOL-18pin

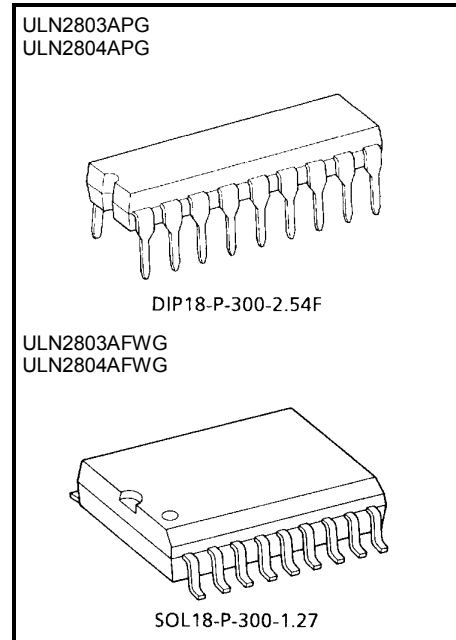

Weight  
 DIP18-P-300-2.54F: 1.478 g (Typ.)  
 SOL18-P-300-1.27 : 0.48 g (Typ.)

Type	Input Base Resistor	Designation
ULN2803APG / AFWG	2.7 kΩ	TTL, 5 V CMOS
ULN2804APG / AFWG	10.5 kΩ	6~15 V PMOS, CMOS

### Pin Connection (top view)

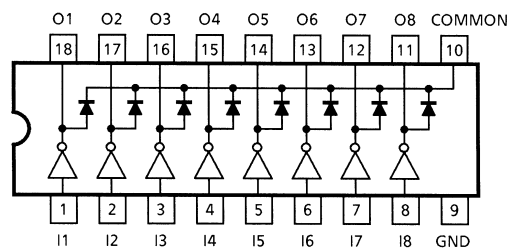

## Schematics (each driver)

ULN2803APG / AFWG

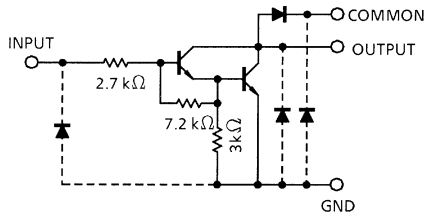

ULN2804APG / AFWG

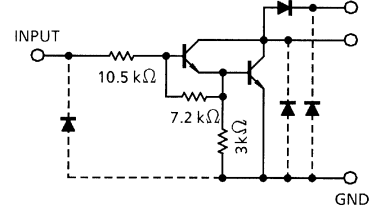

Note: The input and output parasitic diodes cannot be used as clamp diodes.

## Absolute Maximum Ratings (Ta = 25°C)

Characteristic	Symbol	Rating	Unit
Output sustaining voltage	$V_{CE(SUS)}$	-0.5~50	V
Output current	$I_{OUT}$	500	mA / ch
Input voltage	$V_{IN}$	-0.5~30	V
Clamp diode reverse voltage	$V_R$	50	V
Clamp diode forward current	$I_F$	500	mA
Power dissipation	APG	$P_D$	W
	AFWG		
Operating temperature	$T_{opr}$	-40~85	°C
Storage temperature	$T_{stg}$	-55~150	°C

Note: On Glass Epoxy PCB (75 × 114 × 1.6 mm Cu 20%)

## Recommended Operating Conditions (Ta = -40~85°C)

Characteristic		Symbol	Test Condition	Min	Typ.	Max	Unit
Output sustaining voltage		$V_{CE(SUS)}$		0	—	50	V
Output current	APG	$I_{OUT}$	$T_{pw} = 25 \text{ ms, Duty} = 10\%, 8 \text{ Circuits}$	0	—	347	mA / ch
			$T_{pw} = 25 \text{ ms, Duty} = 50\%, 8 \text{ Circuits}$	0	—	123	
	AFWG		$T_{pw} = 25 \text{ ms, Duty} = 10\%, 8 \text{ Circuits}$	0	—	268	
			$T_{pw} = 25 \text{ ms, Duty} = 50\%, 8 \text{ Circuits}$	0	—	90	
Input voltage		$V_{IN}$		0	—	30	V
Input voltage (Output on)	ULN2803A	$V_{IN(ON)}$		3.5	—	30	V
	ULN2804A			8	—	30	
Clamp diode reverse voltage		$V_R$		—	—	50	V
Clamp diode forward current		$I_F$		—	—	400	mA
Power dissipation	APG	$P_D$	$T_a = 85^\circ\text{C}$	—	—	0.76	W
	AFWG		$T_a = 85^\circ\text{C}$ (Note)	—	—	0.48	

Note: On Glass Epoxy PCB (75 × 114 × 1.6 mm Cu 20%)

## Electrical Characteristics (Ta = 25°C)

Characteristic	Symbol	Test Cir-Cuit	Test Condition	Min	Typ.	Max	Unit
Output leakage current ULN2804A	I <sub>CEX</sub>	1	V <sub>CE</sub> = 50 V, Ta = 25°C	—	—	50	μA
			V <sub>CE</sub> = 50 V, Ta = 85°C	—	—	100	
			V <sub>CE</sub> = 50 V, V <sub>IN</sub> = 1 V	—	—	500	
Collector-emitter saturation voltage	V <sub>CE (sat)</sub>	2	I <sub>OUT</sub> = 350 mA, I <sub>IN</sub> = 500 μA	—	1.3	1.6	V
			I <sub>OUT</sub> = 200 mA, I <sub>IN</sub> = 350 μA	—	1.1	1.3	
			I <sub>OUT</sub> = 100 mA, I <sub>IN</sub> = 250 μA	—	0.9	1.1	
Input current ULN2803A ULN2804A	I <sub>IN (ON)</sub>	2	V <sub>IN</sub> = 3.85 V	—	0.93	1.35	mA
			V <sub>IN</sub> = 5 V	—	0.35	0.5	
			V <sub>IN</sub> = 12 V	—	1.0	1.45	
	I <sub>IN (OFF)</sub>	4	I <sub>OUT</sub> = 500 μA, Ta = 85°C	50	65	—	μA
Input voltage (Output on) ULN2803A ULN2804A	V <sub>IN (ON)</sub>	5	V <sub>CE</sub> = 2 V, I <sub>OUT</sub> = 200 mA	—	—	2.4	V
			V <sub>CE</sub> = 2 V, I <sub>OUT</sub> = 250 mA	—	—	2.7	
			V <sub>CE</sub> = 2 V, I <sub>OUT</sub> = 300 mA	—	—	3.0	
			V <sub>CE</sub> = 2 V, I <sub>OUT</sub> = 125 mA	—	—	5.0	
			V <sub>CE</sub> = 2 V, I <sub>OUT</sub> = 200 mA	—	—	6.0	
			V <sub>CE</sub> = 2 V, I <sub>OUT</sub> = 275 mA	—	—	7.0	
			V <sub>CE</sub> = 2 V, I <sub>OUT</sub> = 350 mA	—	—	8.0	
DC current transfer ratio	h <sub>FE</sub>	2	V <sub>CE</sub> = 2 V, I <sub>OUT</sub> = 350 mA	1000	—	—	
Clamp diode reverse current	I <sub>R</sub>	6	Ta = 25°C (Note)	—	—	50	μA
			Ta = 85°C (Note)	—	—	100	
Clamp diode forward voltage	V <sub>F</sub>	7	I <sub>F</sub> = 350 mA	—	—	2.0	V
Input capacitance	C <sub>IN</sub>	—		—	15	—	pF
Turn-on delay	t <sub>ON</sub>	8	R <sub>L</sub> = 125 Ω, V <sub>OUT</sub> = 50 V	—	0.1	—	μs
Turn-off delay	t <sub>OFF</sub>		R <sub>L</sub> = 125 Ω, V <sub>OUT</sub> = 50 V	—	0.2	—	

Note: V<sub>R</sub> = V<sub>R</sub> MAX.

## Test Circuit

### 1. $I_{CEX}$

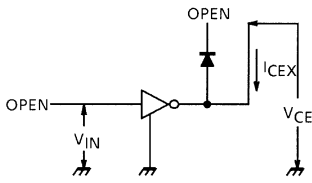

### 2. $V_{CE} (sat), h_{FE}$

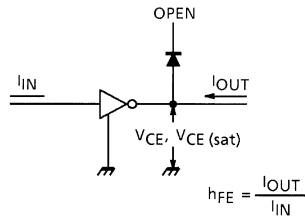

### 3. $I_{IN} (ON)$

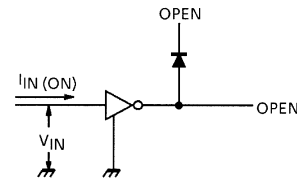

### 4. $I_{IN} (OFF)$

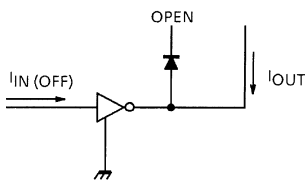

### 5. $V_{IN} (ON)$

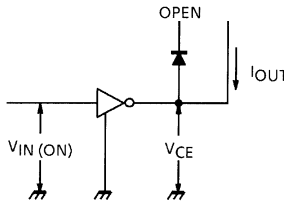

### 6. $I_R$

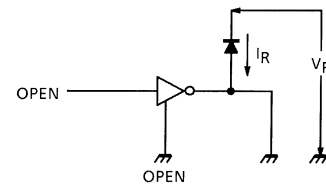

### 7. $V_F$

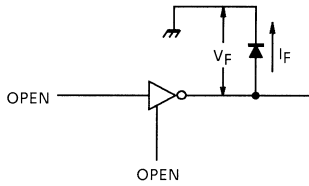

**8.  $t_{ON}$ ,  $t_{OFF}$**

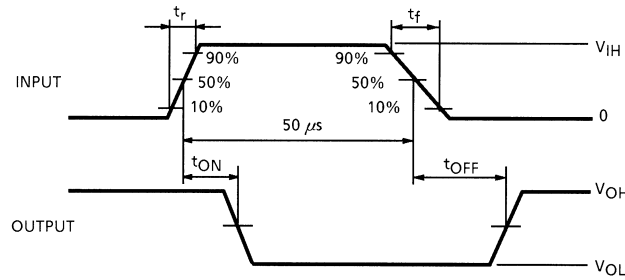
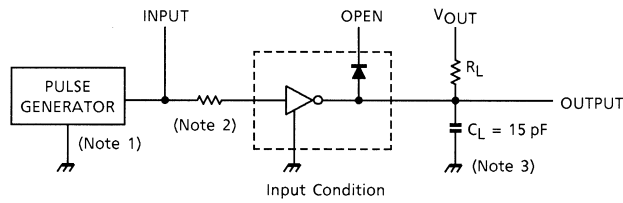

Note 1: Pulse Width 50  $\mu$ s, Duty Cycle 10%  
Output Impedance 50  $\Omega$ ,  $t_r \leq 5$  ns,  $t_f \leq 10$  ns

Note 2: See below.

Input Condition

Type Number	R1	$V_{IH}$
ULN2803A	0 $\Omega$	3 V
ULN2804A	0 $\Omega$	8 V

Note 3:  $C_L$  includes probe and jig capacitance

**Precautions for Using**

This IC does not integrate protection circuits such as overcurrent and overvoltage protectors. Thus, if excess current or voltage is applied to the IC, the IC may be damaged. Please design the IC so that excess current or voltage will not be applied to the IC. Utmost care is necessary in the design of the output line, COMMON and GND line since IC may be destroyed due to short-circuit between outputs, air contamination fault, or fault by improper grounding.

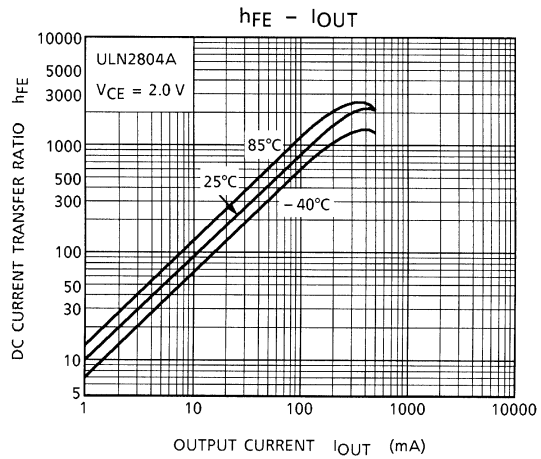
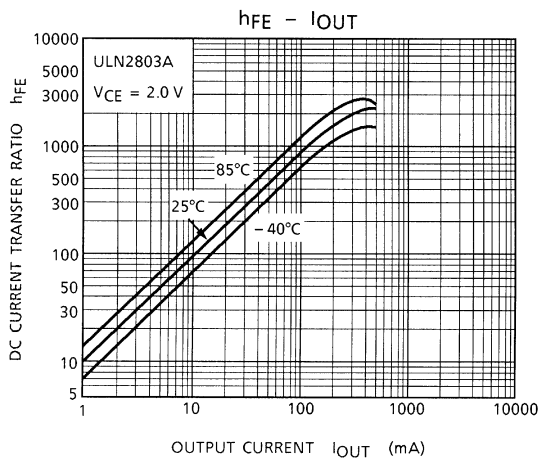
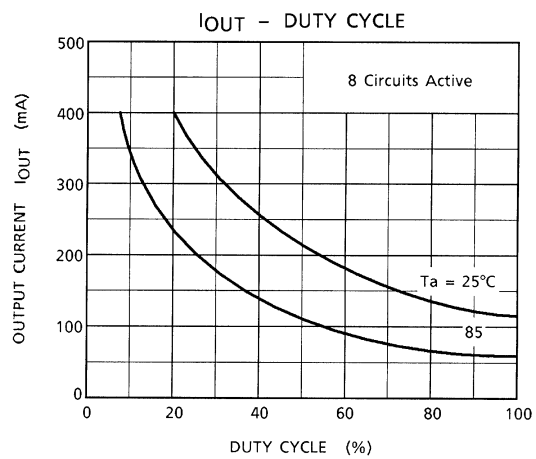
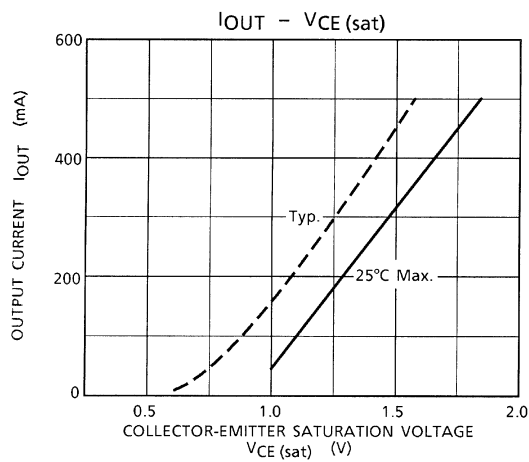
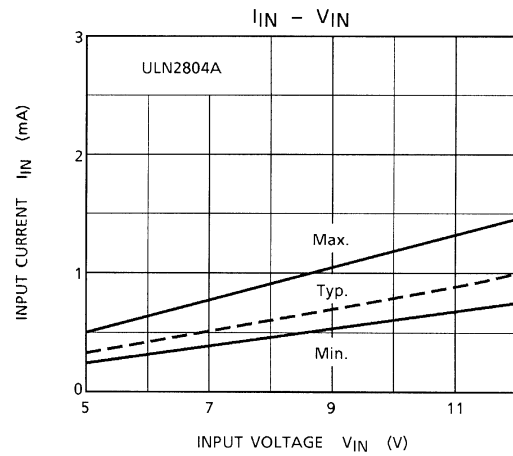
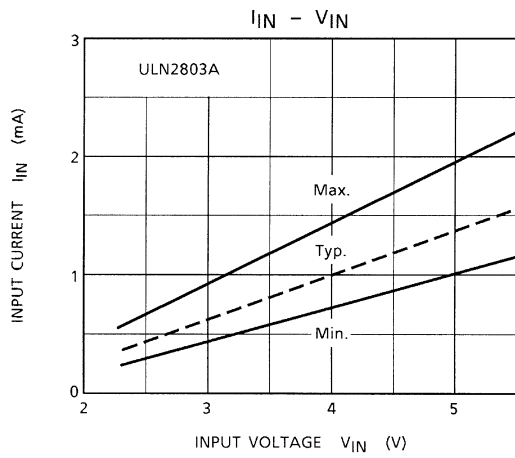

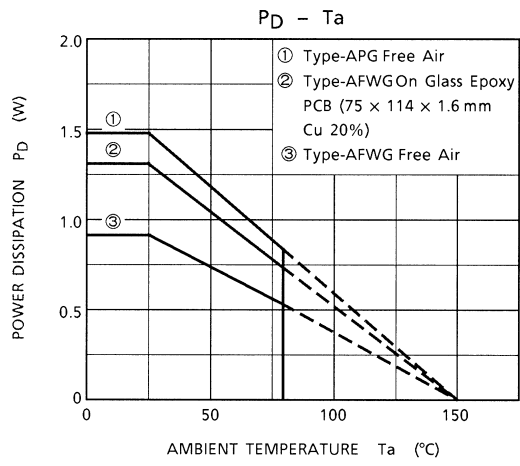



## Package Dimensions

DIP18-P-300-2.54F

Unit: mm

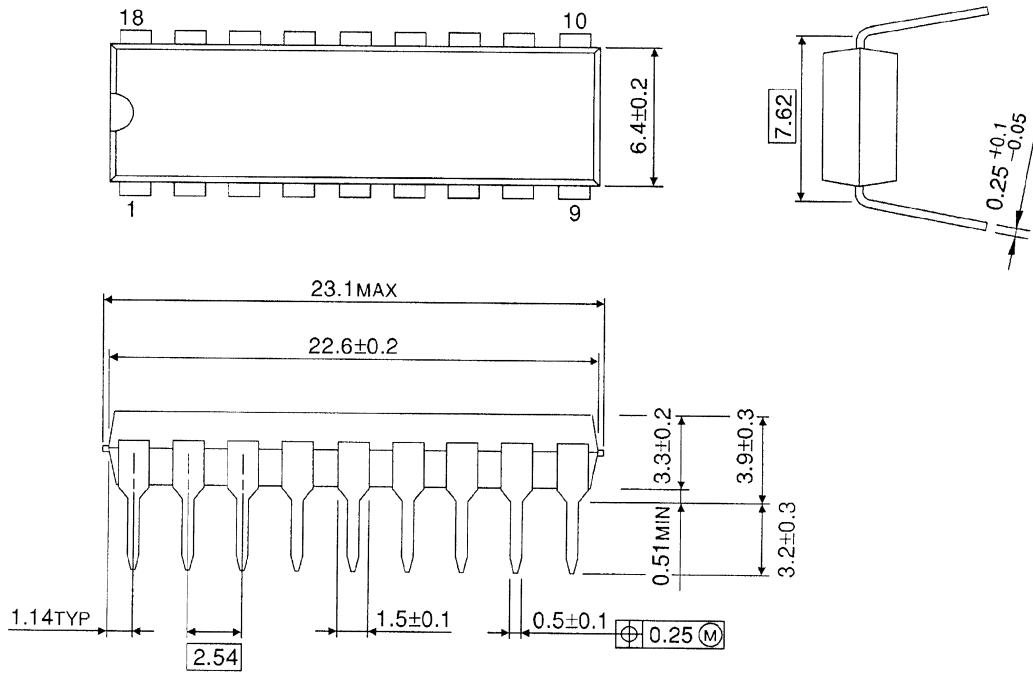

Weight: 1.478 g (Typ.)

## Package Dimensions

SOL18-P-300-1.27

Unit: mm

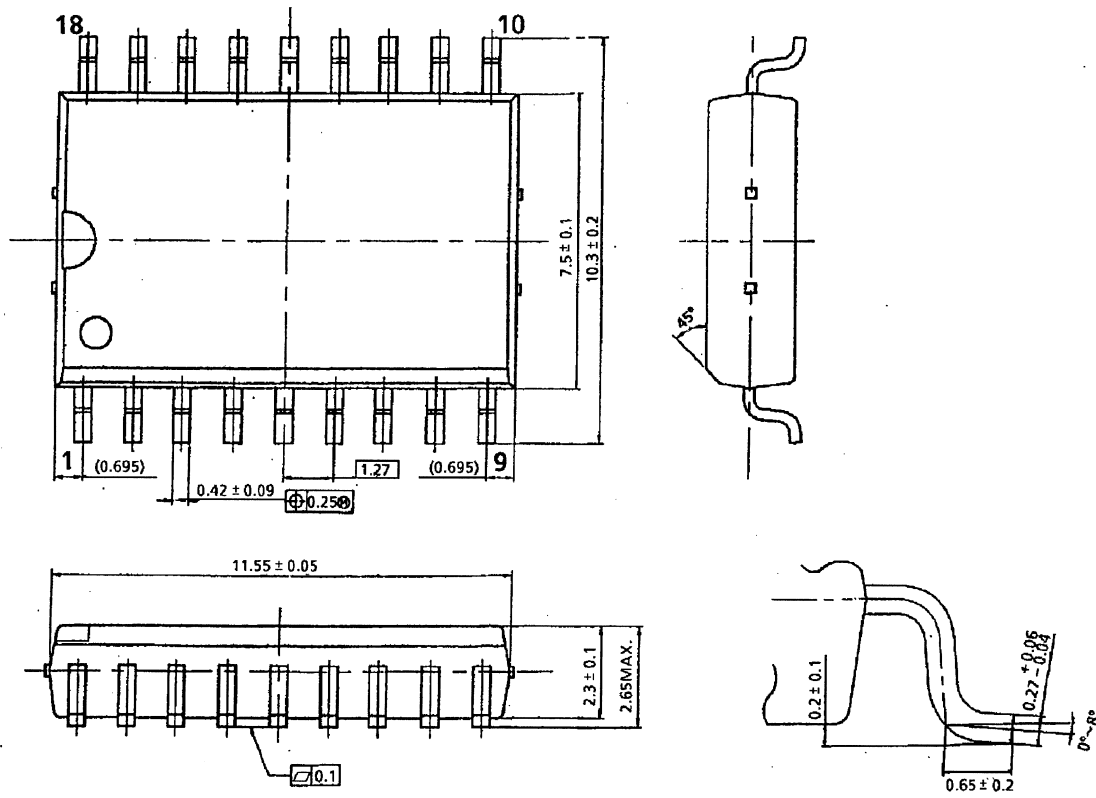

Weight: 0.48 g (Typ.)

**Notes on Contents****1. Schematics**

The schematics may be simplified or some parts of them may be omitted for explanatory purposes.

**2. Absolute Maximum Ratings**

The absolute maximum ratings of a semiconductor device are a set of specified parameter values that must not be exceeded during operation, even for an instant.

If any of these ratings are exceeded during operation, the electrical characteristics of the device may be irreparably altered and the reliability and lifetime of the device can no longer be guaranteed.

Moreover, any exceeding of the ratings during operation may cause breakdown, damage and/or degradation in other equipment. Applications using the device should be designed so that no absolute maximum rating will ever be exceeded under any operating conditions.

Before using, creating and/or producing designs, refer to and comply with the precautions and conditions set forth in this document.

**3. Recommended Operating Conditions**

The values of the conditions are applied within the range of the operating temperature and not guaranteed.

**4. AC Characteristics**

AC characteristics that mean turn-on and turn-off time are targeted design values and not guaranteed.

**5. Application Circuits**

The application circuits shown in this document are provided for reference purposes only. Thorough evaluation is required, especially in the phase of mass production design.

In furnishing these examples of application circuits, Toshiba does not grant the use of any industrial property rights.

**6. Graphics Characteristics**

Graphics characteristics are reference ones and not guaranteed.

**Handling of the IC**

Ensure that the product is installed correctly to prevent breakdown, damage and/or degradation in the product or equipment.

About solderability, following conditions were confirmed

- Solderability
  - (1) Use of Sn-37Pb solder Bath
    - solder bath temperature = 230°C
    - dipping time = 5 seconds
    - the number of times = once
    - use of R-type flux
  - (2) Use of Sn-3.0Ag-0.5Cu solder Bath
    - solder bath temperature = 245°C
    - dipping time = 5 seconds
    - the number of times = once
    - use of R-type flux

## RESTRICTIONS ON PRODUCT USE

060116EBA

- The information contained herein is subject to change without notice. 021023\_D
- TOSHIBA is continually working to improve the quality and reliability of its products. Nevertheless, semiconductor devices in general can malfunction or fail due to their inherent electrical sensitivity and vulnerability to physical stress. It is the responsibility of the buyer, when utilizing TOSHIBA products, to comply with the standards of safety in making a safe design for the entire system, and to avoid situations in which a malfunction or failure of such TOSHIBA products could cause loss of human life, bodily injury or damage to property.  
In developing your designs, please ensure that TOSHIBA products are used within specified operating ranges as set forth in the most recent TOSHIBA products specifications. Also, please keep in mind the precautions and conditions set forth in the "Handling Guide for Semiconductor Devices," or "TOSHIBA Semiconductor Reliability Handbook" etc. 021023\_A
- The TOSHIBA products listed in this document are intended for usage in general electronics applications (computer, personal equipment, office equipment, measuring equipment, industrial robotics, domestic appliances, etc.). These TOSHIBA products are neither intended nor warranted for usage in equipment that requires extraordinarily high quality and/or reliability or a malfunction or failure of which may cause loss of human life or bodily injury ("Unintended Usage"). Unintended Usage include atomic energy control instruments, airplane or spaceship instruments, transportation instruments, traffic signal instruments, combustion control instruments, medical instruments, all types of safety devices, etc. Unintended Usage of TOSHIBA products listed in this document shall be made at the customer's own risk. 021023\_B
- The products described in this document shall not be used or embedded to any downstream products of which manufacture, use and/or sale are prohibited under any applicable laws and regulations. 060106\_Q
- The information contained herein is presented only as a guide for the applications of our products. No responsibility is assumed by TOSHIBA for any infringements of patents or other rights of the third parties which may result from its use. No license is granted by implication or otherwise under any patent or patent rights of TOSHIBA or others. 021023\_C
- The products described in this document are subject to the foreign exchange and foreign trade laws. 021023\_E