



AM Hybrid Transmitter

AM-RT4-XXX
AM-RT5-XXX
AM-RTQ4-XXX
AM-RT14-XXX

Features

- Complete RF Transmitter
- CMOS / TTL Input
- No Adjustable Components
- Very Stable Operating Frequency
- Low Current Consumption
- Low Spurious Emissions

Applications

- Wireless Security Systems
- Car Alarms
- Remote Gate Controls
- Remote Sensing
- Data Capture
- Sensor Reporting

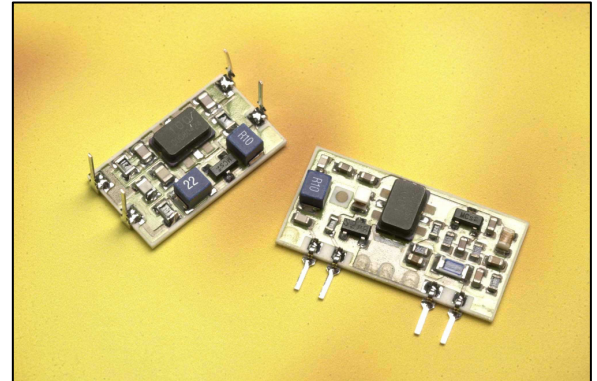

RT4 / RT5

- Available as 315, 418, 433 MHz
- Range up to 70 metres
- SAW Design
- Available In DIL or SIL Package
- Wide Operating Voltage

RTQ4 / RT14

- High Output Power
- PLL Design
- Range 100+ metres
- Available as 433, 868 MHz

Description

The R F Solutions Ltd. AM hybrid transmitter module provides a complete RF transmitter which can be used to transmit data at up to 4KHz from any standard CMOS/TTL source.

The module is very simple to operate and offers low current consumption (typ. 4 mA). Data can be supplied directly from a microprocessor or encoding device, thus keeping the component count down and ensuring a low hardware cost.

The module exhibits extremely stable electronic characteristics due to the use of 'Thick-Film' hybrid technology, which uses no adjustable components and ensures very reliable operation.

The modules are compatible with R F solutions Ltd. range of AM receivers to provide a complete solution.

Ordering Information

Part Number	Description
AM-RT4-XXX	DIL AM Transmitter Module XXX MHz
AM-RTQ4-XXX	DIL AM Transmitter Module XXX MHz
AM-RT5-XXX	SIL AM Transmitter Module XXX MHz
AM-RT14-XXX	DIL AM Transmitter Module XXX MHz, SAW Resonator
AM-RT14-XXX-SO	SMT AM Transmitter Module XXX MHz, SAW Resonator

Frequency Availability

RT4 / RT5:	XXX = 315, 418, 433MHz	Other Frequencies available on request
RTQ4:	XXX = 868MHz	Other Frequencies available on request
RT14:	XXX = 433MHz	Other Frequencies available on request





AM Hybrid Transmitter

AM-RT4-XXX
 AM-RT5-XXX
 AM-RTQ4-XXX
 AM-RT14-XXX

Mechanical Dimensions

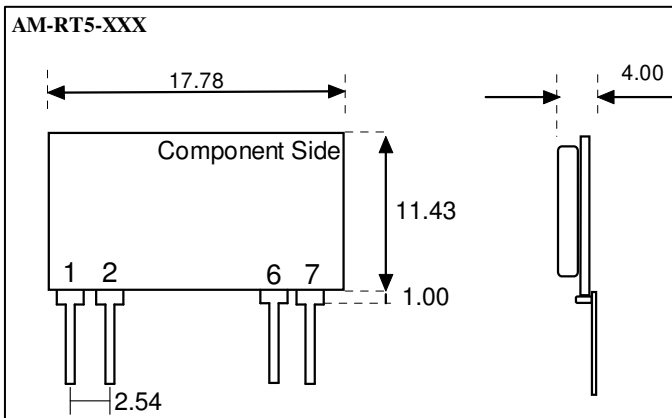
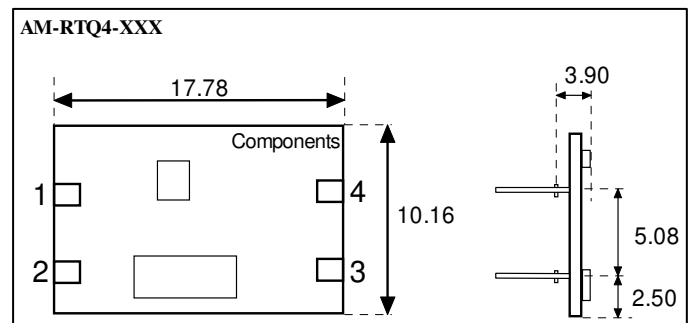
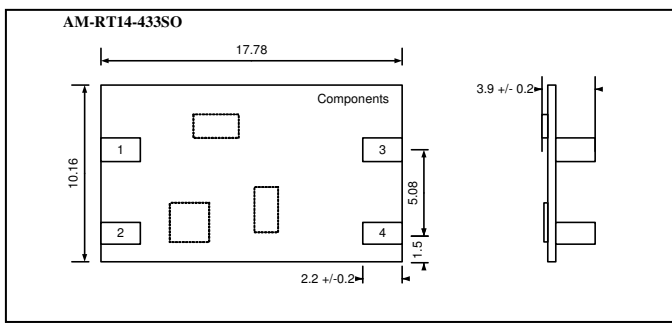
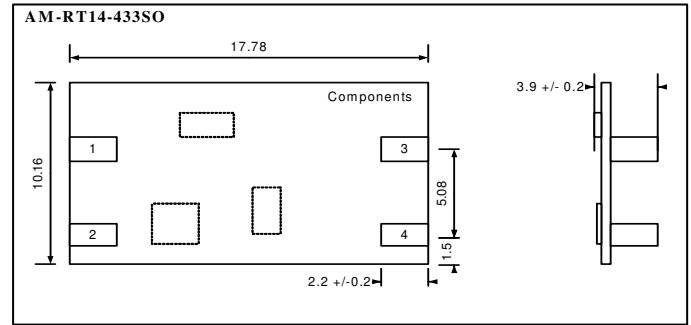
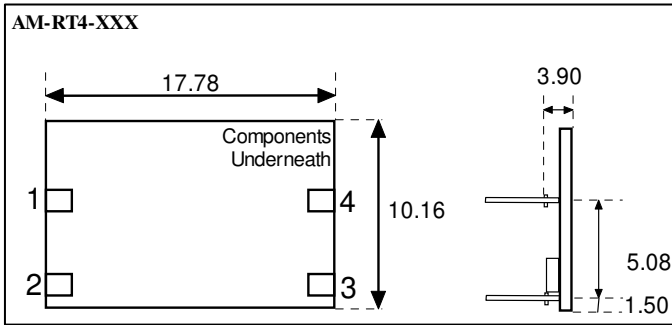

Notes

- Pins on 0.1" pitch
- Pin Dimensions: 0.25 x 0.50mm
- All measurements in mm
- Tolerance: +/- 0.2mm

The component side differs depending on module

Pin Descriptions

RT4 / RTQ4 / RT14	RT5	Name	Description
1	7	Vcc	Supply Voltage
2	6	GND	Ground, Connect to RF earth return path
3	2	IN	Data input
4	1	ANT	External Antenna



AM Hybrid Transmitter

AM-RT4-XXX
AM-RT5-XXX
AM-RTQ4-XXX
AM-RT14-XXX

Typical Application

For further information on this circuit please see datasheet DS600

Transmitter Circuit

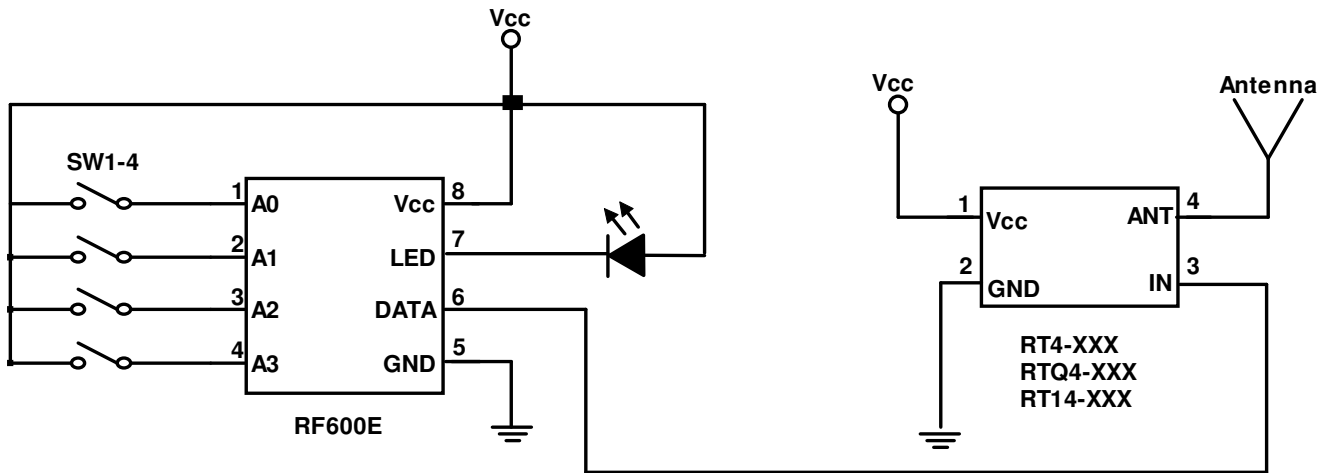



AM Hybrid Transmitter

AM-RT4-XXX
AM-RT5-XXX
AM-RTQ4-XXX
AM-RT14-XXX

RT4/RT5: Electrical Characteristics

Ambient temp = 25 °C unless otherwise stated.

Characteristic	Min.	Typ.	Max.	Dimensions
Supply Voltage	2		14	Vdc
Supply Current (Vcc=5V IN=1kHz)		4		mA
Supply Current (Vcc=5V IN=DC GND)		50		nA
Working Frequency	303.8		433.92	MHz
Frequency Tolerance		+/-100		KHz
RF Output Power into 50Ω (Vcc=5V)		0		dBm
Harmonic Spurious Emissions		-30		dBc
Input Voltage High	2		Vcc	V
Time from Power on to data transmission		10		µSec
Data Rate	50		9,600	bps
Operating Temperature	-25		+80	°C

RTQ4: Electrical Characteristics

Ambient temp = 25 °C unless otherwise stated.

Characteristic	Min.	Typ.	Max.	Dimensions
Supply Voltage	1.9		5	Vdc
Supply Current (Vcc=5V IN=1kHz)		12		mA
Working Frequency		868.35		MHz
Frequency Tolerance	-35		+35	KHz
RF Output Power into 50Ω (Vcc=4V)	+5	+7		dBm
Harmonic Spurious Emissions		-50		dBc
Input Voltage High	0.7*Vcc			V
Power-Up			1	mSec
Data Rate	50		9,600	bps
Operating Temperature	-25		+80	°C

RT14: Electrical Characteristics

Ambient temp = 25 °C unless otherwise stated.

Characteristic	Min.	Typ.	Max.	Dimensions
Supply Voltage	2		9	Vdc
Supply Current (Vcc=5V IN=1kHz)		8		mA
Working Frequency		433.92		MHz
RF Output Power into 50Ω (Vcc=4V)	+10	+12		dBm
Harmonic Spurious Emissions		-55		dBc
Input Voltage High	2		Vcc	V
Data Rate	50		9,600	Hz
Operating Temperature	-25		+80	°C

**R. F. Solutions Ltd.,
Unit 21, Cliffe Industrial Estate,
South Street, Lewes,
E Sussex, BN8 6JL, England.**

Tel +44 (0)1273 898 000. Fax +44 (0)1273 480 661.

Email: sales@rfsolutions.co.uk Web: <http://www.rfsolutions.co.uk>