

Features

- Available in E6 series
- Low height of only 4.8 mm
- High I rms of 4.0 amps
- RoHS compliant*

Applications

- Input/output of DC/DC converters
- Power supplies for:
 - Portable communications equipment
 - Camcorders
 - LCD TVs
 - Car radios

SDR1105 Series - SMD Power Inductors

Electrical Specifications

Bourns Part Number	Inductance 1 kHz		RDC Max. (Ω)	I rms Max. (A)	I sat Typ. (A)
	(μ H)	Tol. %			
SDR1105-100ML	10	± 20	0.045	4.00	8.0
SDR1105-120ML	12	± 20	0.048	3.80	8.0
SDR1105-150ML	15	± 20	0.052	3.50	8.0
SDR1105-180ML	18	± 20	0.070	3.30	7.0
SDR1105-220ML	22	± 20	0.080	3.00	6.5
SDR1105-270ML	27	± 20	0.090	2.80	5.0
SDR1105-330KL	33	± 10	0.100	2.60	5.0
SDR1105-390KL	39	± 10	0.140	2.40	4.5
SDR1105-470KL	47	± 10	0.170	2.20	4.0
SDR1105-560KL	56	± 10	0.200	2.00	3.5
SDR1105-680KL	68	± 10	0.210	1.80	3.5
SDR1105-820KL	82	± 10	0.300	1.60	3.0
SDR1105-101KL	100	± 10	0.320	1.50	2.8
SDR1105-151KL	150	± 10	0.500	1.20	2.3
SDR1105-201KL	200	± 10	0.650	1.00	1.8

General Specifications

Test Frequency 1 KHz
 Test Voltage 1 V
 Reflow Soldering .. 230 °C, 50 sec. max.
 Operating Temperature
 -40 °C to +125 °C
 (Temperature rise included)
 Storage Temperature
 -40 °C to +125 °C
 Resistance to Soldering Heat
 +260 °C for 5 sec.

Materials

Core Ferrite DR
 Wire Enameled copper
 Base FR-4
 Terminal Cu/Ni/Au
 Rated Current
 Ind. drop 10 % typ. at I sat
 Temperature Rise
 40 °C max. at rated I rms
 Packaging 800 pcs. per reel

Electrical Schematic

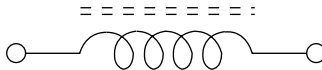

Packaging Specifications

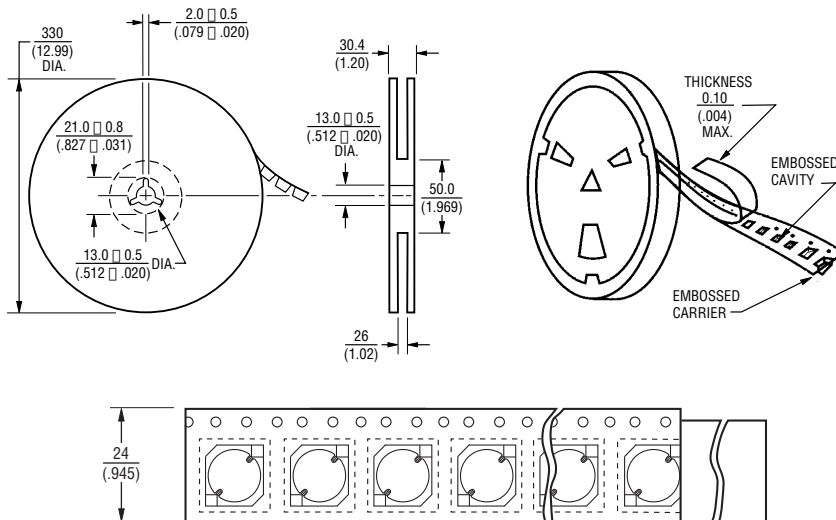

QTY: 800 PCS. PER REEL

DIMENSIONS: $\frac{\text{MM}}{\text{(INCHES)}}$

Product Dimensions

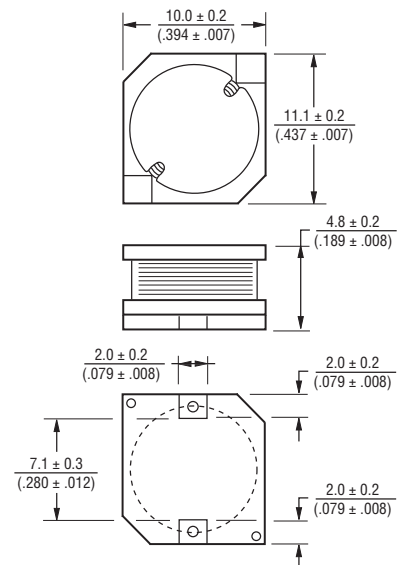

Recommended Layout

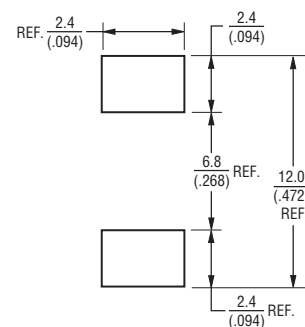

REV. 04/15

*RoHS Directive 2002/95/EC Jan. 27, 2003 including annex and RoHS Recast 2011/65/EU June 8, 2011. Specifications are subject to change without notice.

The device characteristics and parameters in this data sheet can and do vary in different applications and actual device performance may vary over time.

Users should verify actual device performance in their specific applications.