

PRODUCT SPECIFICATION

DATE:11/29/2012

cosmo ELECTRONICS CORPORATION	Photocoupler : KPC357NT	NO.61P04115	REV. 8
		SHEET 1 OF 7	

Mini-Flat package General purpose Photocoupler

● Features

1. Halogen Free.
2. Pb free and RoHS compliant.
3. Mini-flat package:
compact 4 pin SOP with a 2.0mm profile
4. Current transfer ratio
(CTR : MIN.50% at IF=5mA Vce=5V)
5. Isolation voltage between input and output (Viso : 3750vrms).
6. Agency Approvals
 - UL approved : No.E169586
 - VDE approved : No.40014684
 - FIMKO approved : EN 60065 No. FI 23147 A1
EN 60950 No. FI 24583 A1
 - CQC approved : No. CQC04001010530

● Applications

1. Hybrid substrates that require high density mounting.
2. Programmable controllers.

PRODUCT SPECIFICATION

DATE:11/29/2012

cosmo ELECTRONICS CORPORATION	Photocoupler :	NO.61P04115	REV.
	KPC357NT	SHEET 2 OF 7	8

1. OUTSIDE DIMENSION : UNIT (mm)

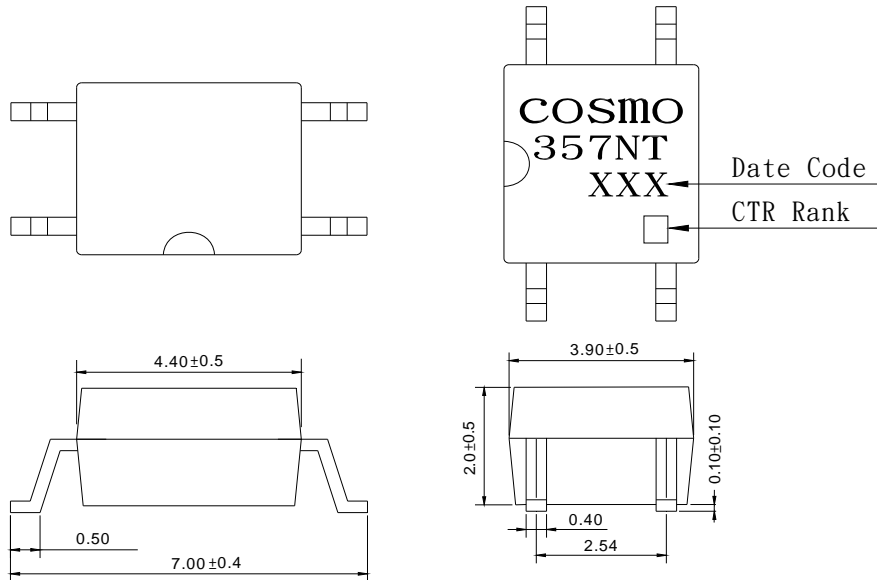

TOLERANCE : ± 0.2 mm

2. SCHEMATIC : TOP VIEW

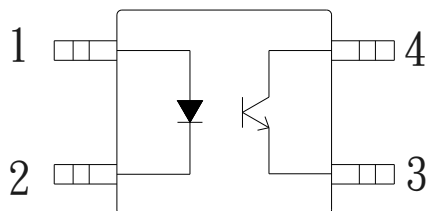

1. Anode
2. Cathode
3. Emitter
4. Collector

PRODUCT SPECIFICATION

DATE:11/29/2012

cosmo ELECTRONICS CORPORATION	Photocoupler :	NO.61P04115	REV. 8
	KPC357NT	SHEET 3 OF 7	

●Absolute Maximum Ratings

Parameter	Symbol	Rating	Unit	
Input	Forward current	I_F	50	mA
	Peak forward current	I_{FM}	1	A
	Reverse voltage	V_R	6	V
	Power dissipation	P	70	mW
Output	Collector-emitter voltage	V_{CEO}	80	V
	Emitter-collector voltage	V_{ECO}	5	V
	Collector current	I_c	50	mA
	Collector power dissipation	P_c	150	mW
Total power dissipation	P_{tot}	170	mW	
Isolation voltage 1 minute	V_{iso}	3750	Vrms	
Operating temperature	T_{opr}	-55 to +115	°C	
Storage temperature	T_{stg}	-55 to +125	°C	
Soldering temperature 10 second	T_{sol}	260	°C	

●Electro-optical Characteristics

Parameter	Symbol	Conditions	MIN.	TYP.	MAX.	Unit
Input	Forward voltage	V_F $I_F=20mA$	-	1.2	1.4	V
	Reverse current	I_R $V_R=4V$	-	-	10	uA
	Terminal capacitance	C_t $V=0, f=1kHz$	-	30	250	pF
Output	Collector dark current	I_{CEO} $V_{CE}=20V, I_F=0$	-	-	0.1	uA
	Collector-emitter breakdown voltage	BV_{CEO} $I_c=100uA, I_F=0$	80	-	-	V
	Emitter-collector breakdown voltage	BV_{ECO} $I_E=100uA, I_F=0$	5	-	-	V
Transfer characteristics	Current transfer ratio	CTR $I_F=5mA, V_{CE}=5V$	50	-	600	%
	Collector-emitter saturation voltage	$V_{CE(sat)}$ $I_F=20mA, I_c=1mA$	-	0.1	0.3	V
	Isolation resistance	R_{iso} DC500V, 40 to 60%RH	5×10^{10}	10^{11}	-	ohm
	Floating capacitance	C_f $V=0, f=1MHz$	-	0.6	1.0	pF
	Response time (Rise)	t_r $V_{ce}=2V, I_c=2mA, R_L=100ohm$	-	5	20	us
Response time (Fall)	t_f	-	4	20	us	

●Classification table of current transfer ratio is shown below.

CTR RANK	CTR(%)
KPC357NT0A	80 TO 160
KPC357NT0B	130 TO 260
KPC357NT0C	200 TO 400
KPC357NT0D	300 TO 600
KPC357NT0E	50 TO 600

PRODUCT SPECIFICATION

DATE:11/29/2012

cosmo ELECTRONICS CORPORATION	Photocoupler :	NO.61P04115	REV. 8
	KPC357NT	SHEET 4 OF 7	

Fig.1 Forward Current vs.Ambient Temperature

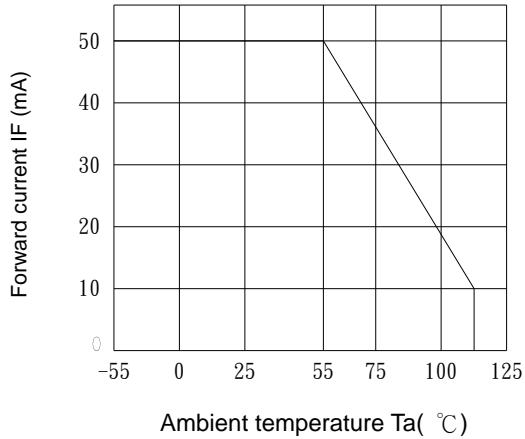

Fig.2 Diode Power Dissipation vs. Ambient Temperature

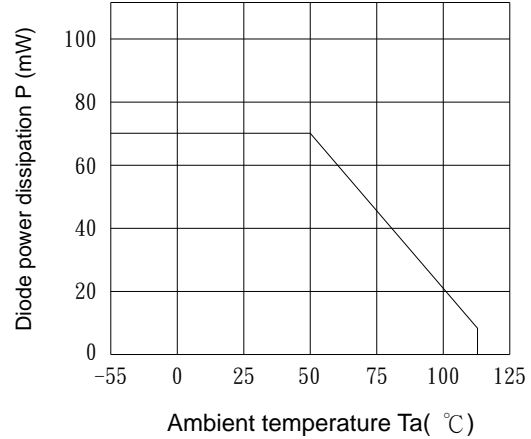

Fig.3 Collector Power Dissipation vs. Ambient Temperature

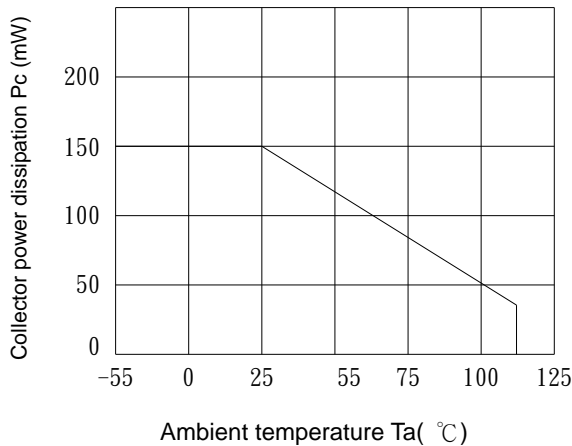

Fig.4 Total Power Dissipation vs. Ambient Temperature

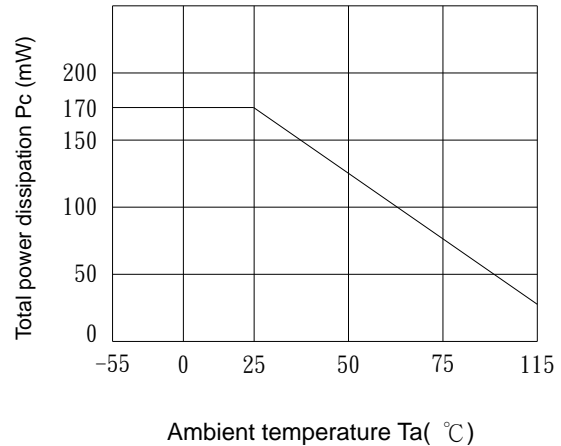

Fig.5 Peak Forward Current vs. Duty Ratio

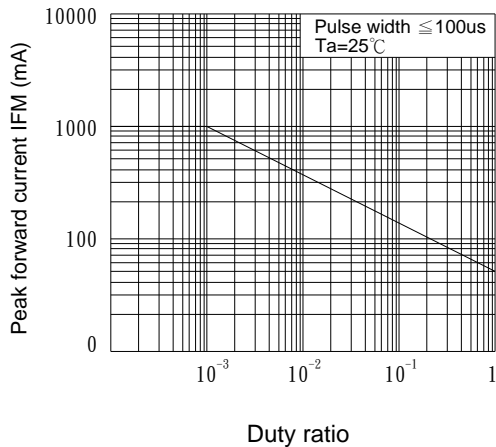
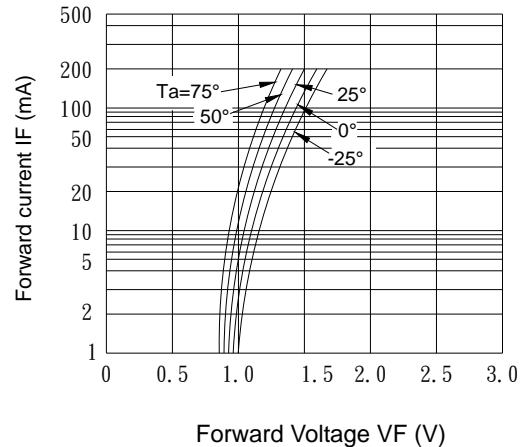

Fig.6 Forward Current vs. Forward Voltage



PRODUCT SPECIFICATION

DATE:11/29/2012

cosmo ELECTRONICS CORPORATION	Photocoupler :	NO.61P04115	REV. 8
	KPC357NT	SHEET 5 OF 7	

Fig.7 Current Transfer Ratio vs. Forward Current

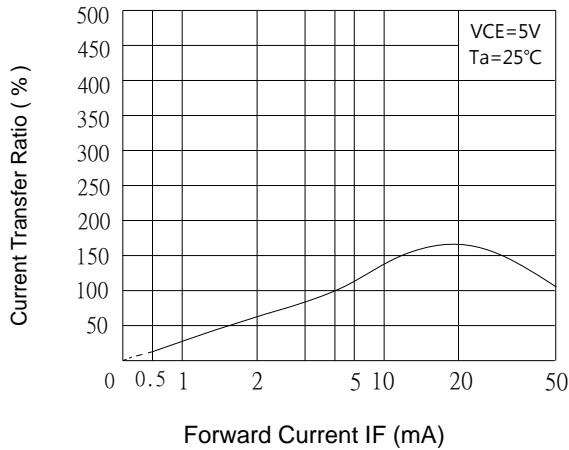

Fig.8 Collector Current vs. Collector-Emitter Voltage

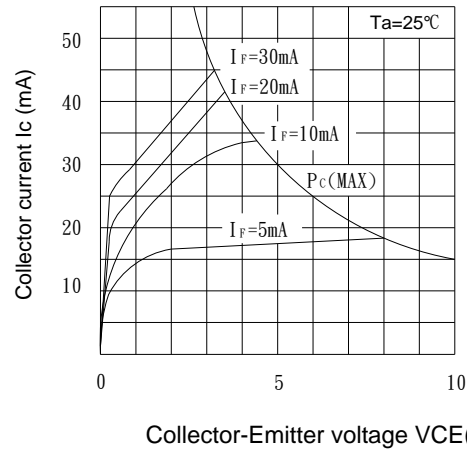

Fig.9 Relative Current Transfer Ratio vs. Ambient Temperature

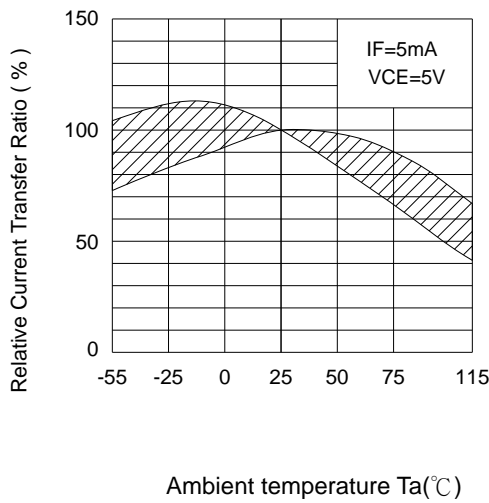

Fig.10 Collector-Emitter Saturation Voltage vs. Ambient Temperature

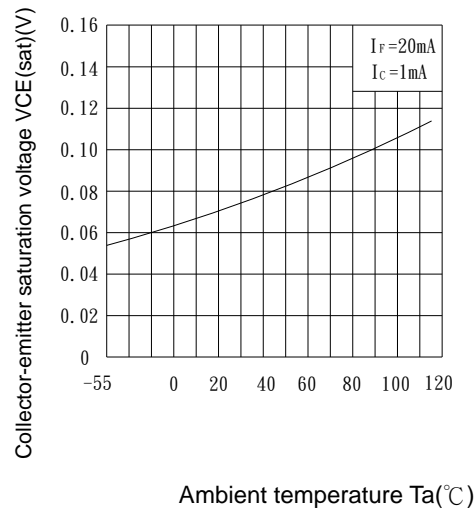

Fig.11 Collector Dark Current vs. Ambient Temperature

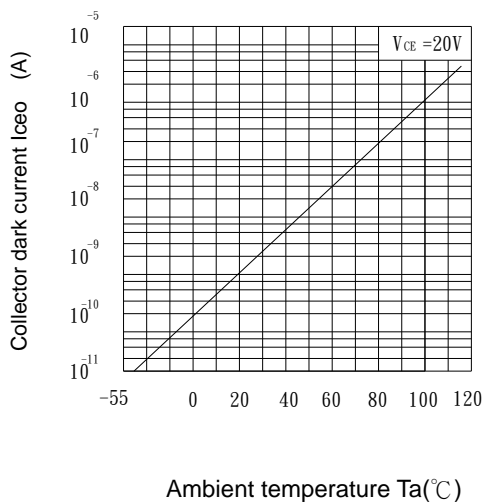
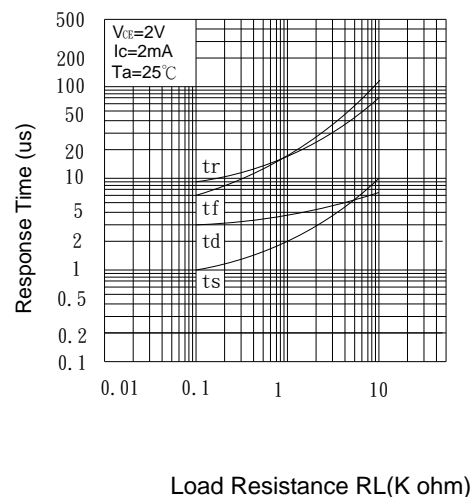

Fig.12 Response Time vs. Load Resistance



PRODUCT SPECIFICATION

DATE:11/29/2012

cosmo ELECTRONICS CORPORATION	Photocoupler :	NO.61P04115	REV.
	KPC357NT	SHEET 6 OF 7	8

Fig.13 Forward Current vs.
Forward Voltage

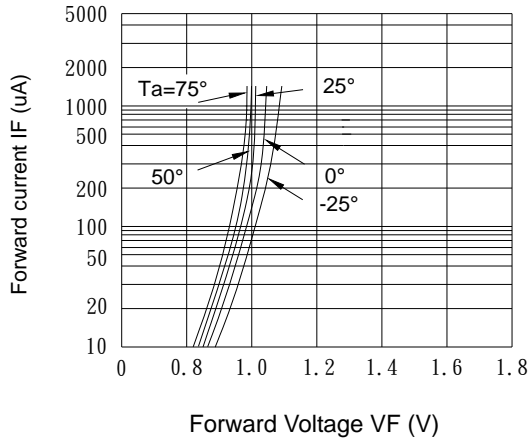

PRODUCT SPECIFICATION

DATE:11/29/2012

cosmo ELECTRONICS CORPORATION	Photocoupler : KPC357NT	NO.61P04115	REV. 8
		SHEET 7 OF 7	

NOTICE

The information contained in this document is a general product description and is subject to change without notice. Please contact cosmo in order to obtain the latest device data sheets before using any cosmo device. cosmo does not assume any responsibility for use of any circuitry described. No circuit patent licenses are implied. This publication is the property of cosmo. No part of this publication may be reproduced or copied in any form or by any means, or transferred to any third party without the prior written consent of cosmo Electronics Corporation.

The devices listed in this document are designed for general applications only in electronic equipment. No devices shall be deployed which require higher level of reliability such as:

- Medical and other life support equipments.
- Space application.
- Telecommunication equipment (trunk lines).
- Nuclear power control equipment.

Unless it received prior written approval from cosmo.

cosmo takes no responsibility for damages arise form the improper usage of our device. Please contact cosmo for further information regarding the above notices.