



FAN7382 Half-Bridge Gate Driver

Features

- Floating Channels Designed for Bootstrap Operation to +600V
- Typically 350mA/650mA Sourcing/Sinking Current Driving Capability for Both Channels
- Common-Mode dv/dt Noise Canceling Circuit
- Extended Allowable Negative VS Swing to -9V for Signal Propagation @ VCC=VBS=15V
- VCC & VBS Supply Range from 10V to 20V
- UVLO Functions for Both Channels
- TTL Compatible Input Logic Threshold Levels
- Matched Propagation Delay Below 50nsec
- Output In-phase with Input

Applications

- PDP Scan Driver
- Fluorescent Lamp Ballast
- SMPS
- Motor Driver

Description

The FAN7382, a monolithic half-bridge gate driver IC, can drive MOSFETs and IGBTs that operate up to +600V. Fairchild's high-voltage process and common-mode noise canceling technique provides stable operation of the high-side driver under high dv/dt noise circumstances. An advanced level shift circuit allows high-side gate driver operation up to $V_{GS} = -9.8$ V (typ.) for $V_{BS} = 15$ V. The input logic level is compatible with standard TTL-series logic gates. UVLO circuits for both channels prevent malfunction when VCC and VBS are lower than the specified threshold voltage. Output drivers typically source/sink 350mA/650mA, respectively, which is suitable for fluorescent lamp ballasts, PDP scan drivers, motor controls, etc.

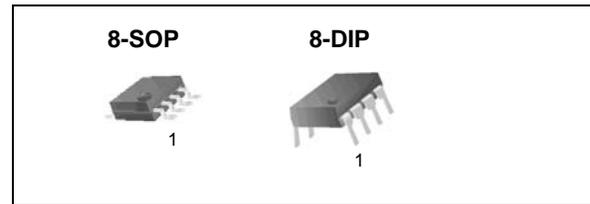

Ordering Information

Part Number	Package	Pb-Free	Operating Temperature Range	Packing Method
FAN7382N	8-DIP	Yes	-40°C ~ 125°C	TUBE
FAN7382M	8-SOP	Yes		TUBE
FAN7382MX		Yes		TAPE & REEL

Pin Assignments

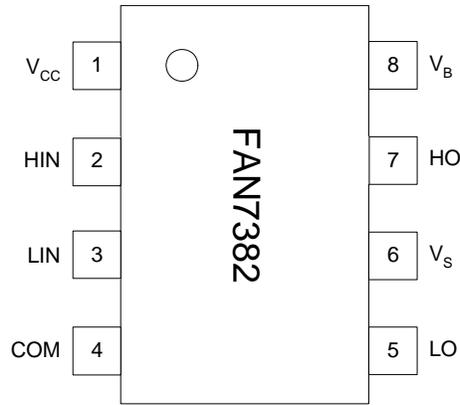

FAN7382 Rev.03

Pin Definitions

Pin	Name	Function/ Description
1	VCC	Low-Side Supply Voltage
2	HIN	Logic Input for High-Side Gate Driver Output
3	LIN	Logic Input for Low-Side Gate Driver Output
4	COM	Logic Ground and Low-Side Driver Return
5	LO	Low-Side Driver Output
6	VS	High-Voltage Floating Supply Return
7	HO	High-Side Driver Output
8	VB	High-Side Floating Supply

Absolute Maximum Ratings

The "Absolute Maximum Ratings" are those values beyond which the safety of the device cannot be guaranteed. The device should not be operated at these limits. The parametric values defined in the Electrical Characteristics tables are not guaranteed at the absolute maximum ratings.

Symbol	Characteristics	Min.	Max.	Unit
V_S	High-side offset voltage	V_B-25	$V_B+0.3$	V
V_B	High-side floating supply voltage	-0.3	625	
V_{HO}	High-side floating output voltage HO	$V_S-0.3$	$V_B+0.3$	
V_{CC}	Low-side and logic fixed supply voltage	-0.3	25	
V_{LO}	Low-side output voltage LO	-0.3	$V_{CC}+0.3$	
V_{IN}	Logic input voltage(HIN, LIN)	-0.3	$V_{CC}+0.3$	
COM	Logic ground	$V_{CC}-25$	$V_{CC}+0.3$	
dVs/dt	Allowable offset voltage SLEW RATE	-	50	
P_D	Power dissipation	SOP	0.625	W
		DIP	1.2	
Rthja	Thermal resistance, junction-to-ambient	SOP	200	°C/W
		DIP	100	
T_J	Junction temperature	-	150	°C
T_S	Storage temperature	-	150	°C

Electrical Characteristics

($V_{BIAS}(V_{CC}, V_{BS})=15.0V$, $T_A = 25^\circ C$, unless otherwise specified. The V_{IN} , V_{TH} , and I_{IN} parameters are referenced to COM. The V_O and I_O parameters are referenced to COM and V_S is applicable to HO and LO.)

Symbol	Characteristics	Test Condition	Min.	Typ.	Max.	Unit
VCCUV+ VBSUV+	VCC and VBS supply under-voltage positive going threshold		8.2	9.2	10.0	V
VCCUV- VBSUV-	VCC and VBS supply under-voltage negative going threshold		7.6	8.7	9.6	
VCCUVH VBSUVH	VCC supply under-voltage lockout hysteresis		-	0.6	-	
I_{LK}	Offset supply leakage current	$V_B=V_S=600V$	-	-	50	μA
I_{QBS}	Quiescent VBS supply current	$V_{IN}=0V$ or $5V$	-	45	120	
I_{QCC}	Quiescent VCC supply current	$V_{IN}=0V$ or $5V$	-	70	180	
I_{PBS}	Operating VBS supply current	$f_{in}=20kHz$, rms value	-	-	600	μA
I_{PCC}	Operating VCC supply current	$f_{in}=20kHz$, rms value	-	-	600	
V_{IH}	Logic "1" input voltage		2.9	-	-	V
V_{IL}	Logic "0" input voltage		-	-	0.8	
V_{OH}	High level output voltage, $V_{BIAS}-V_O$	$I_O=20mA$	-	-	1.0	
V_{OL}	Low level output voltage, V_O		-	-	0.6	
I_{IN+}	Logic "1" input bias current	$V_{IN}=5V$	-	10	20	μA
I_{IN-}	Logic "0" input bias current	$V_{IN}=0V$	-	1.0	2.0	
I_{O+}	Output high short circuit pulse current	$V_O=0V, V_{IN}=5V$ with $PW<10\mu s$	250	350	-	mA
I_{O-}	Output low short circuit pulsed current	$V_O=15V=V_B, V_{IN}=0V$ with $PW<10\mu s$	500	650	-	
VS	Allowable negative VS pin voltage for HIN signal propagation to HO		-	-9.8	-7	V

Dynamic Electrical Characteristics

($V_{BIAS}(V_{CC}, V_{BS})=15.0V$, $V_S=COM$, $C_L=1000pF$ and $T_A = 25^\circ C$, unless otherwise specified.)

Symbol	Characteristics	Test Condition	Min.	Typ.	Max.	Unit
t_{on}	Turn-on propagation delay	$V_S=0V$	100	170	300	ns
t_{off}	Turn-off propagation delay	$V_S=0V$ or $600V$	100	200	300	
t_r	Turn-on rise time		20	60	140	
t_f	Turn-off fall time		-	30	80	
MT	Delay matching, HS & LS turn-on/off		-	-	50	

Typical Characteristics

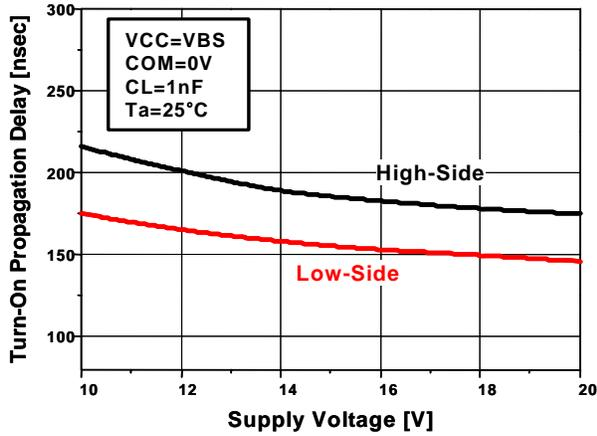

Figure 1. Turn-On Propagation Delay vs. Supply Voltage

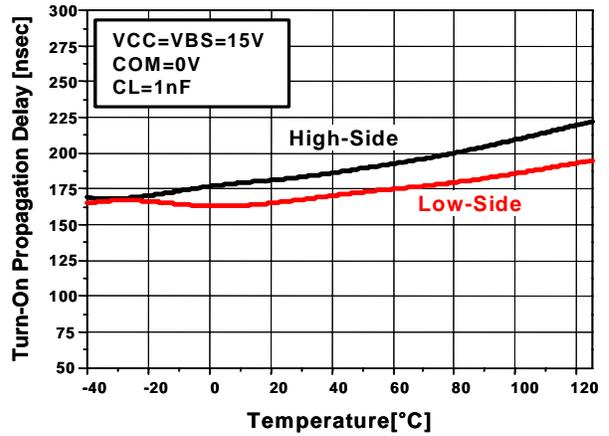

Figure 2. Turn-On Propagation Delay vs. Temp.

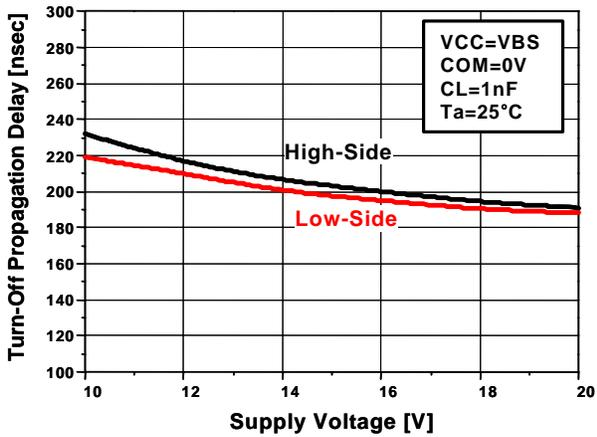

Figure 3. Turn-Off Propagation Delay vs. Supply Voltage

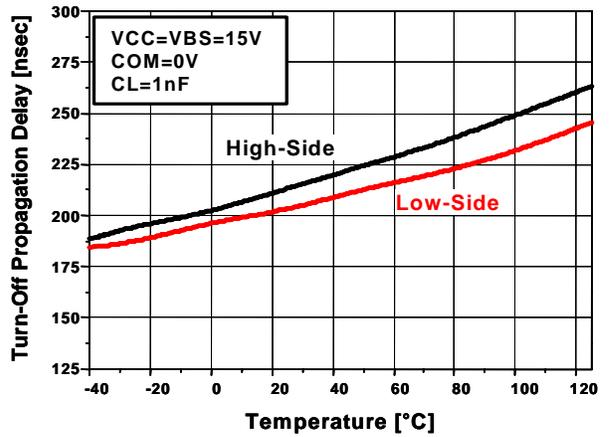

Figure 4. Turn-Off Propagation Delay vs. Temp.

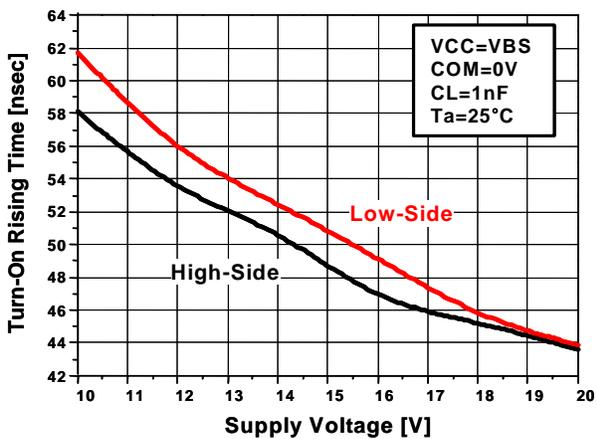

Figure 5. Turn-On Rising Time vs. Supply Voltage

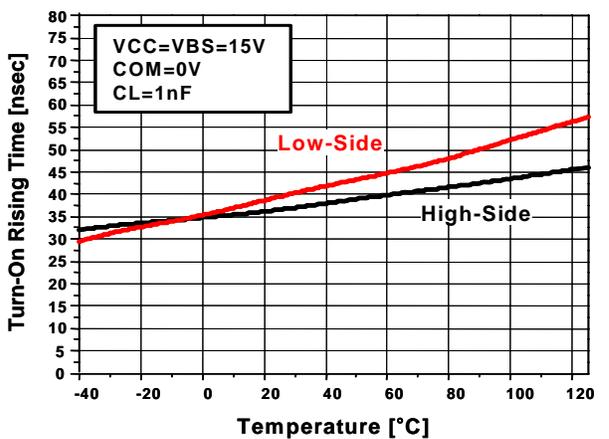

Figure 6. Turn-On Rising Time vs. Temp.

Typical Characteristics (Continued)

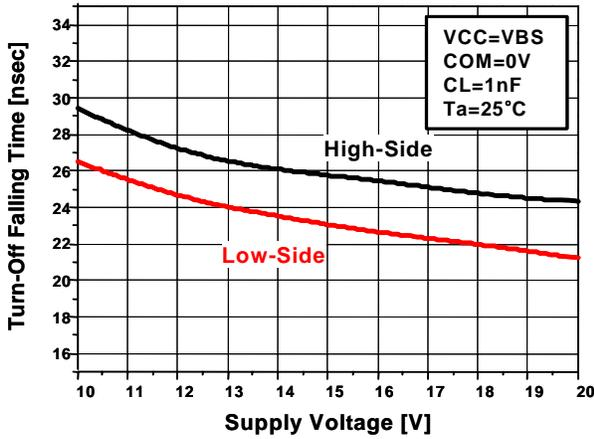

Figure 7. Turn-Off Falling Time vs. Supply Voltage

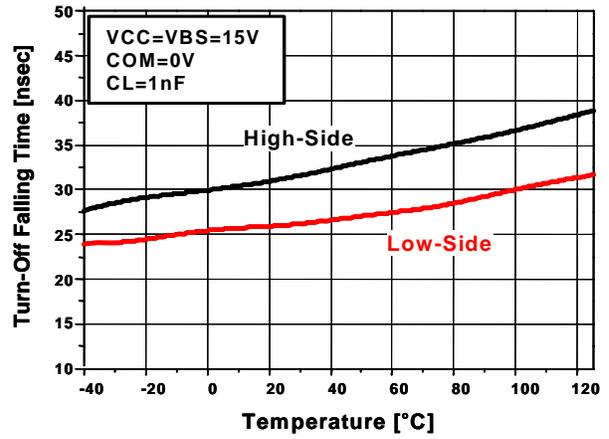

Figure 8. Turn-Off Falling Time vs. Temp.

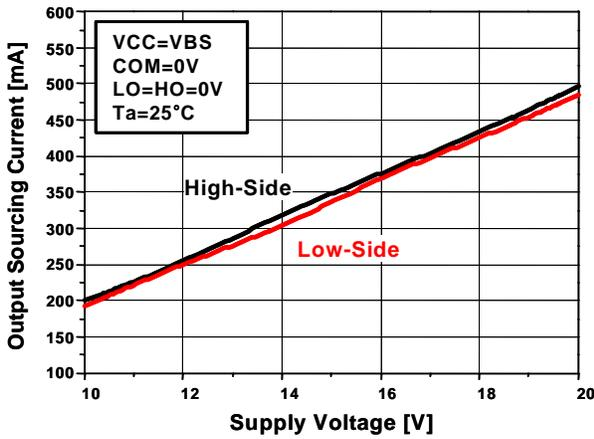

Figure 9. Output Sourcing Current vs. Supply Voltage

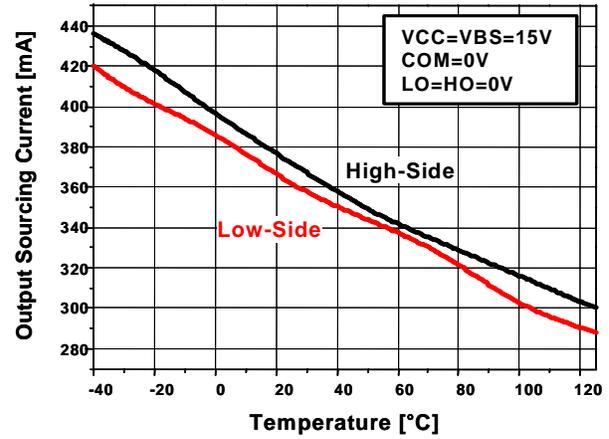

Figure 10. Output Sourcing Current vs. Temp.

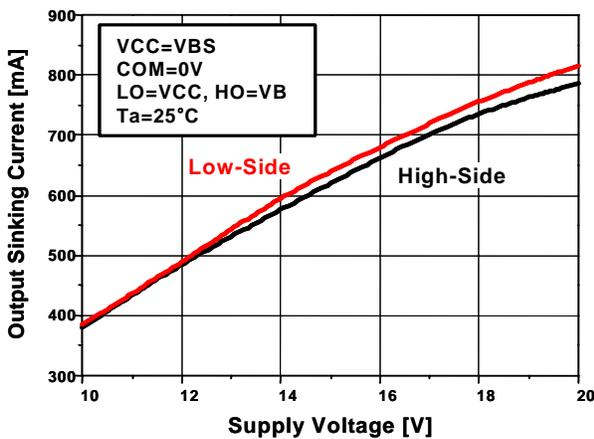

Figure 11. Output Sinking Current vs. Supply Voltage

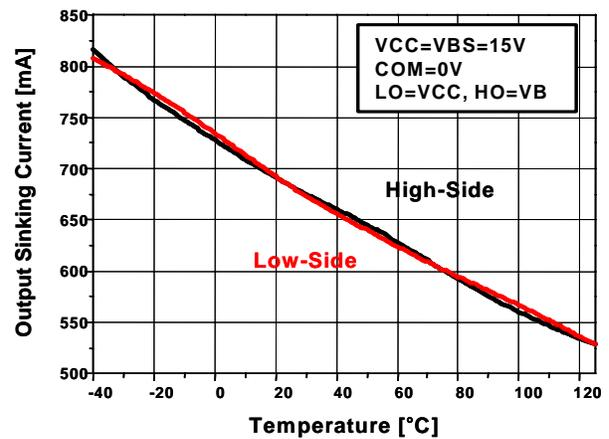

Figure 12. Output Sinking Current vs. Temp.

Typical Characteristics (Continued)

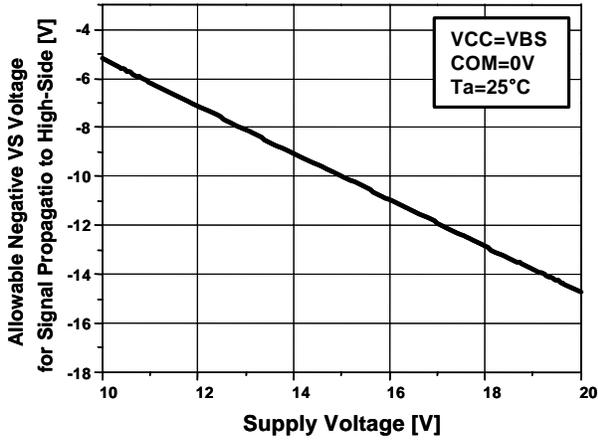

Figure 13. Allowable Negative VS Voltage for Signal Propagation to High Side vs. Supply Voltage

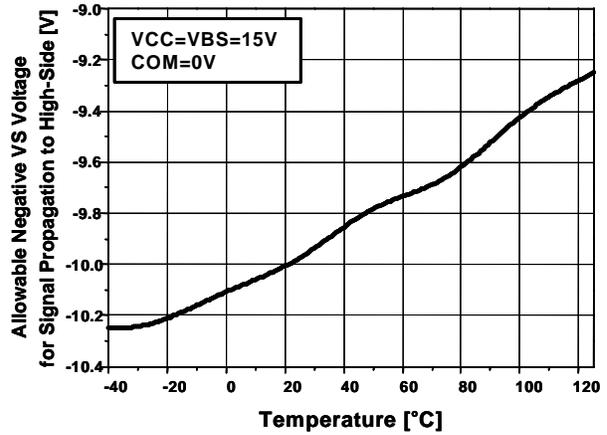

Figure 14. Allowable Negative VS Voltage for Signal Propagation to High Side vs. Temp.

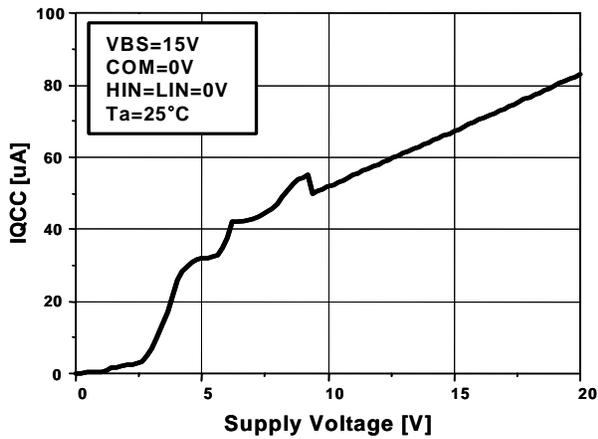

Figure 15. IQCC vs. Supply Voltage

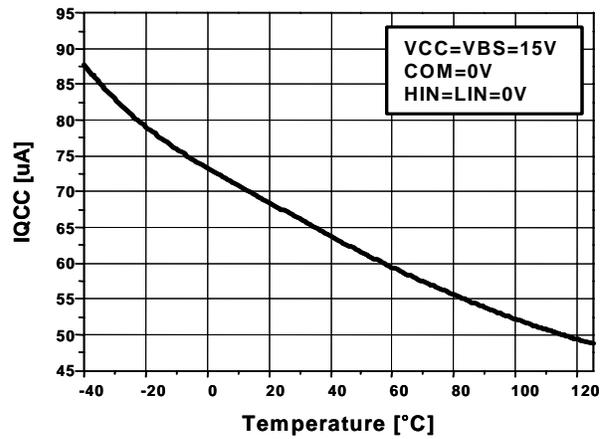

Figure 16. IQCC vs. Temp.

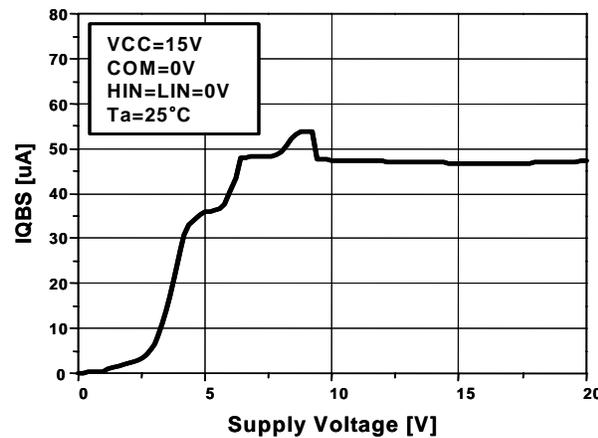

Figure 17. IQBS vs. Supply Voltage

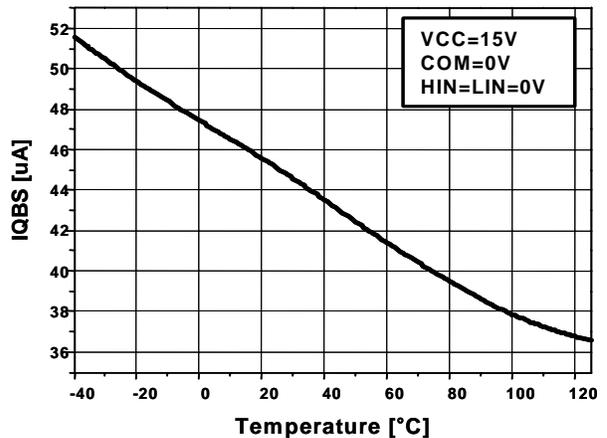

Figure 18. IQBS vs. Temp.

Typical Characteristics (Continued)

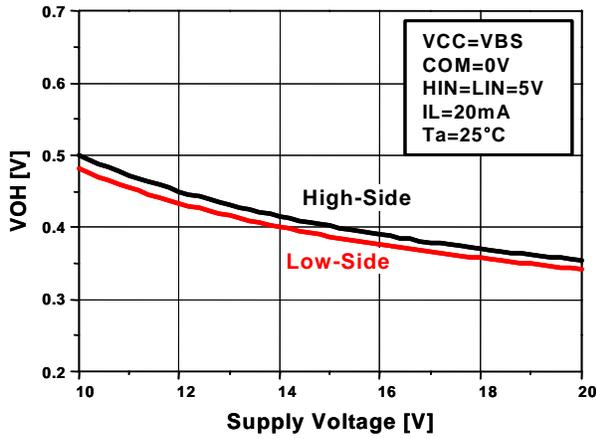

Figure 19. High-Level Output Voltage vs. Supply Voltage

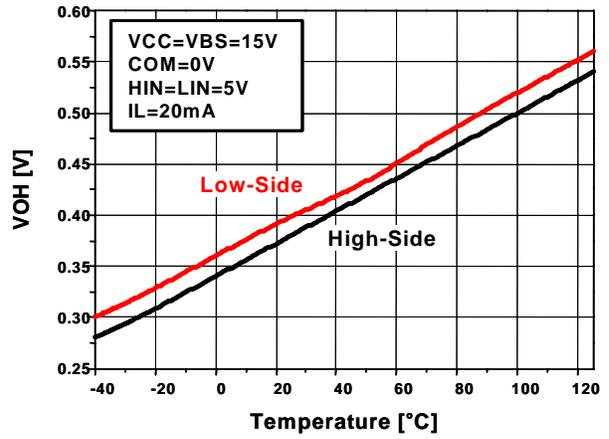

Figure 20. High-Level Output Voltage vs. Temp.

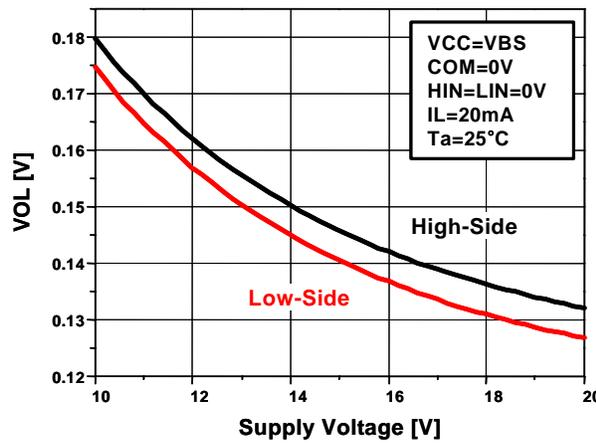

Figure 21. Low-Level Output Voltage vs. Supply Voltage

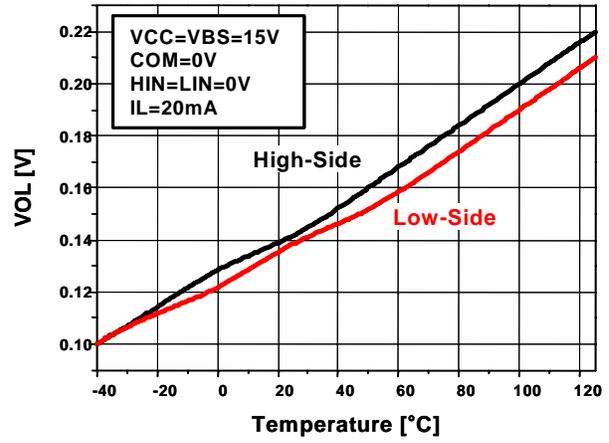

Figure 22. Low-Level Output Voltage vs. Temp.

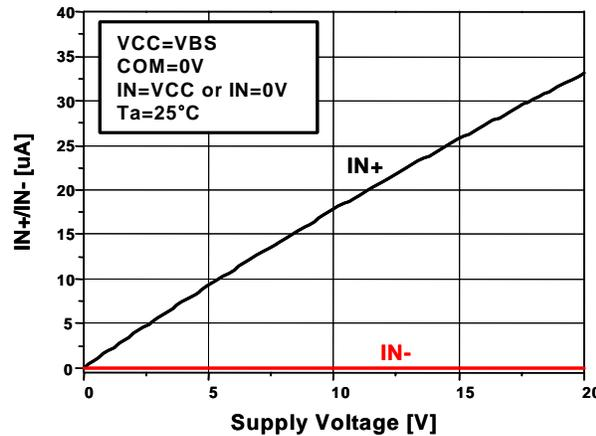

Figure 23. Input Bias Current vs. Supply Voltage

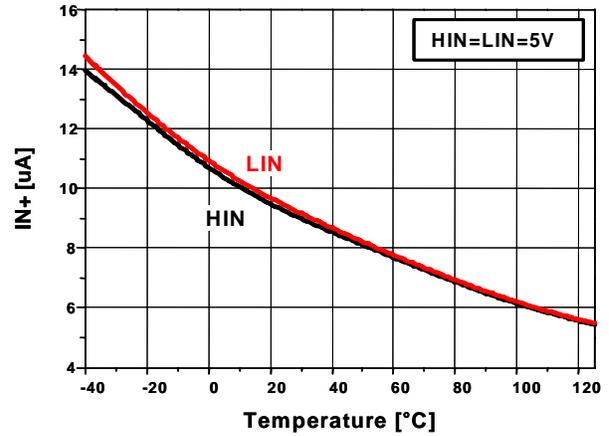

Figure 24. Input Bias Current vs. Temp.

Typical Characteristics (Continued)

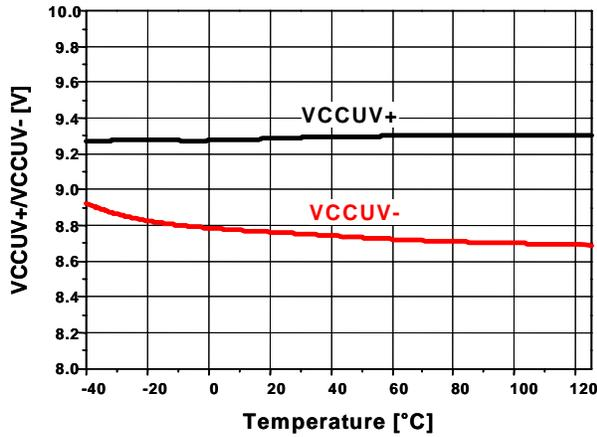

Figure 25. VCC UVLO Threshold Voltage vs. Temp.

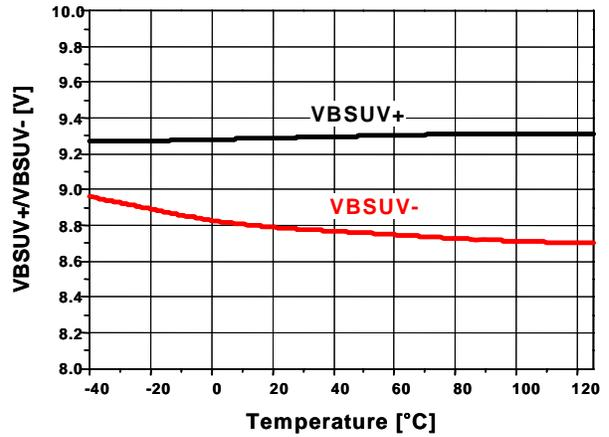

Figure 26. VBS UVLO Threshold Voltage vs. Temp.

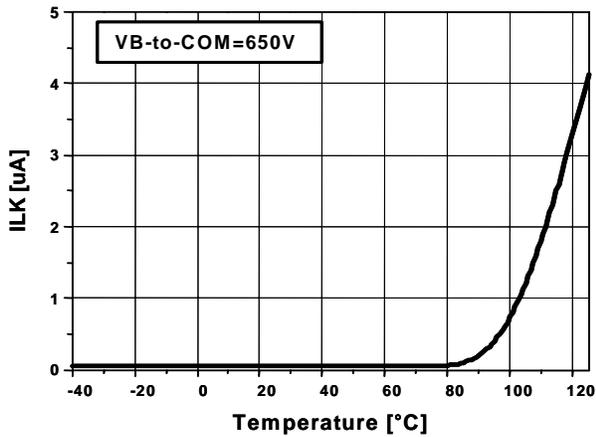

Figure 27. VB to COM Leakage Current vs. Temp.

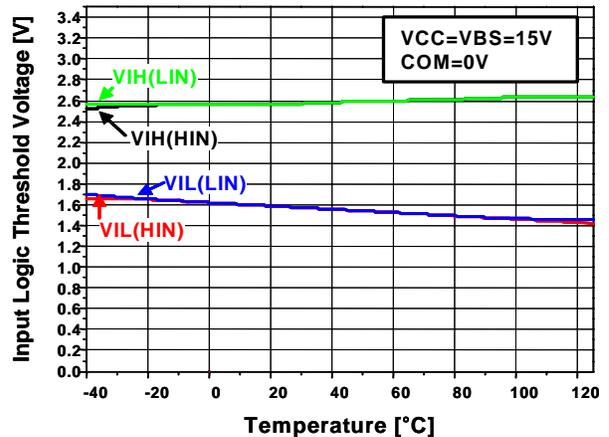

Figure 28. Input Logic Threshold Voltage vs. Temp.

Typical Characteristics (Continued)

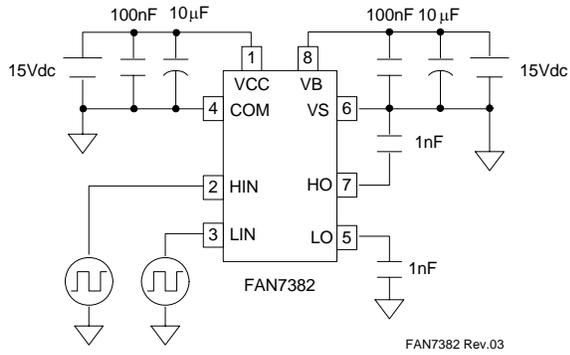

Figure 29. Switching Time Test Circuit

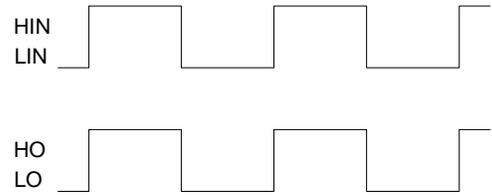

Figure 30. Input / Output Timing Diagram

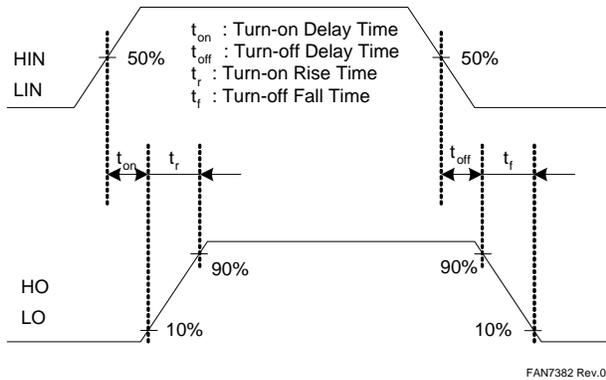

Figure 31. Switching Time Waveform Definitions

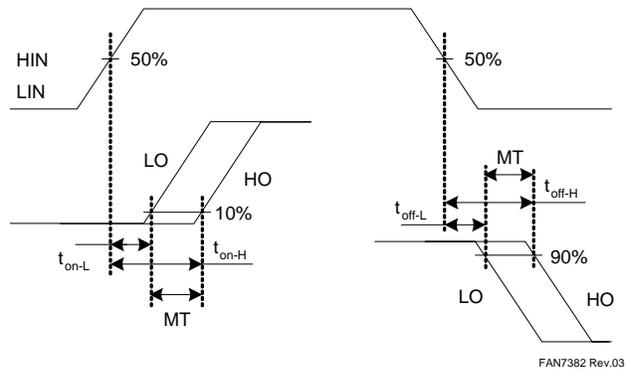
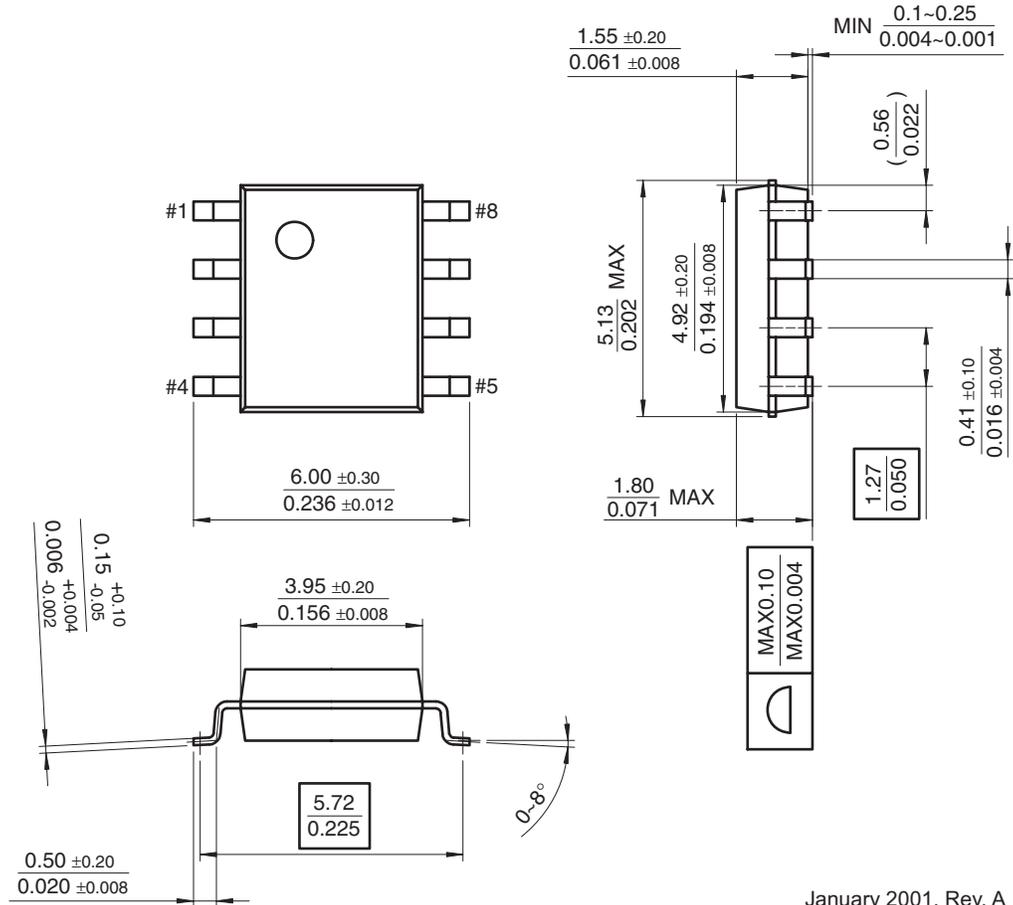

Figure 32. Delay Matching Waveform Definition

Mechanical Dimensions

8-SOP

Dimensions are in millimeters (inches) unless otherwise noted.



January 2001, Rev. A

Mechanical Dimensions (Continued)

8-DIP

Dimensions are in millimeters (inches) unless otherwise noted.

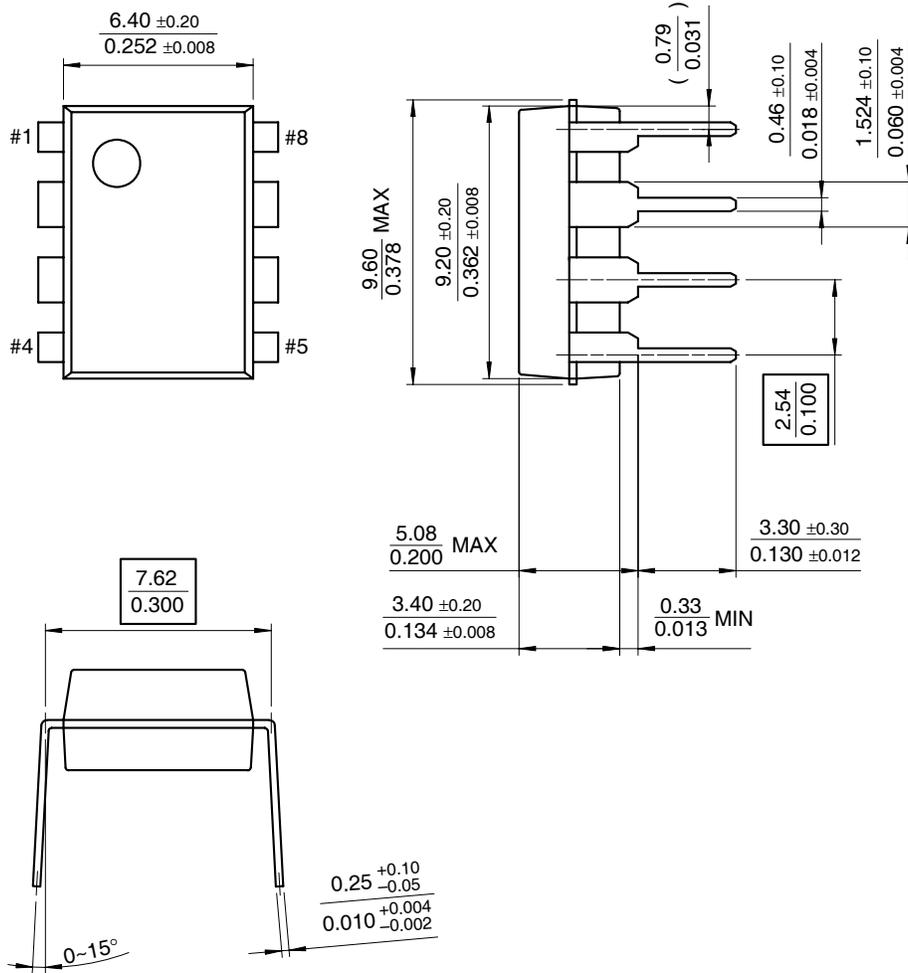

September 1999, Rev B

TRADEMARKS

The following are registered and unregistered trademarks Fairchild Semiconductor owns or is authorized to use and is not intended to be an exhaustive list of all such trademarks.

ACEx™	GlobalOptoisolator™	OCXPro™	μSerDes™	TinyBuck™
ActiveArray™	GTO™	OPTOLOGIC®	SILENT SWITCHER®	TinyLogic®
Bottomless™	HiSeC™	OPTOPLANAR™	SMART START™	TINYOPTO™
Build it Now™	I ² C™	PACMAN™	SPM™	TinyPower™
CoolFET™	<i>i-Lo</i> ™	POP™	Stealth™	TinyPWM™
CROSSVOL™	ImpliedDisconnect™	Power247™	SuperFET™	TruTranslation™
DOME™	IntelliMAX™	PowerEdge™	SuperSOT™-3	UHC™
EcoSPARK™	ISOPLANAR™	PowerSaver™	SuperSOT™-6	UltraFET®
E ² CMOS™	LittleFET™	PowerTrench®	SuperSOT™-8	UniFET™
EnSigna™	MICROCOUPLER™	QFET®	SyncFET™	VCX™
FACT™	MicroFET™	QS™	TCM™	Wire™
FACT Quiet Series™	MicroPak™	QT Optoelectronics™	TinyBoost™	
FAST®	MICROWIRE™	Quiet Series™		
FASTr™	MSX™	RapidConfigure™	Across the board. Around the world.™	
FPS™	MSXPro™	RapidConnect™	Programmable Active Droop™	
FRFET™	OCX™	ScalarPump™	The Power Franchise®	

DISCLAIMER

FAIRCHILD SEMICONDUCTOR RESERVES THE RIGHT TO MAKE CHANGES WITHOUT FURTHER NOTICE TO ANY PRODUCTS HEREIN TO IMPROVE RELIABILITY, FUNCTION OR DESIGN. FAIRCHILD DOES NOT ASSUME ANY LIABILITY ARISING OUT OF THE APPLICATION OR USE OF ANY PRODUCT OR CIRCUIT DESCRIBED HEREIN; NEITHER DOES IT CONVEY ANY LICENSE UNDER ITS PATENT RIGHTS, NOR THE RIGHTS OF OTHERS. THESE SPECIFICATIONS DO NOT EXPAND THE TERMS OF FAIRCHILD'S WORLDWIDE TERMS AND CONDITIONS, SPECIFICALLY THE WARRANTY THEREIN, WHICH COVERS THESE PRODUCTS.

LIFE SUPPORT POLICY

FAIRCHILD'S PRODUCTS ARE NOT AUTHORIZED FOR USE AS CRITICAL COMPONENTS IN LIFE SUPPORT DEVICES OR SYSTEMS WITHOUT THE EXPRESS WRITTEN APPROVAL OF FAIRCHILD SEMICONDUCTOR CORPORATION.

As used herein:

- Life support devices or systems are devices or systems which, (a) are intended for surgical implant into the body or (b) support or sustain life, and (c) whose failure to perform when properly used in accordance with instructions for use provided in the labeling, can be reasonably expected to result in a significant injury of the user.
- A critical component in any component of a life support device, or system whose failure to perform can be reasonably expected to cause the failure of the life support device or system, or to affect its safety or effectiveness.

PRODUCT STATUS DEFINITIONS**Definition of Terms**

Datasheet Identification	Product Status	Definition
Advance Information	Formative or In Design	This datasheet contains the design specifications for product development. Specifications may change in any manner without notice.
Preliminary	First Production	This datasheet contains preliminary data; supplementary data will be published at a later date. Fairchild Semiconductor reserves the right to make changes at any time without notice to improve design.
No Identification Needed	Full Production	This datasheet contains final specifications. Fairchild Semiconductor reserves the right to make changes at any time without notice to improve design.
Obsolete	Not In Production	This datasheet contains specifications on a product that has been discontinued by Fairchild Semiconductor. The datasheet is printed for reference information only.

Rev. I20