

SWITCH MODE POWER SUPPLY CONTROLLER

- POSITIVE AND NEGATIVE CURRENT UP TO 1.2A and - 2A
- LOW START-UP CURRENT
- DIRECT DRIVE OF THE POWER TRANSISTOR
- TWO LEVELS TRANSISTOR CURRENT LIMITATION
- DOUBLE PULSE SUPPRESSION
- SOFT-STARTING
- UNDER AND OVERVOLTAGE LOCK-OUT
- AUTOMATIC STAND-BY MODE RECOGNITION
- LARGE POWER RANGE CAPABILITY IN STAND-BY (Burst mode)
- INTERNAL PWM SIGNAL GENERATOR

DESCRIPTION

The TEA2260/61 is a monolithic integrated circuit for the use in primary part of an off-line switching mode power supply.

All functions required for SMPS control under normal operating, transient or abnormal conditions are provided.

The capability of working according to the "master-slave" concept, or according to the "primary regulation" mode makes the TEA2260/61 very flexible and easy to use. This is particularly true for TV receivers where the IC provides an attractive and low cost solution (no need of stand-by auxiliary power supply). See application note AN376/0490 for detailed information.

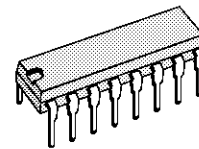

BATWING DIP 16
(Plastic Package)

ORDER CODES : TEA2260 - TEA2261

PIN CONNECTIONS

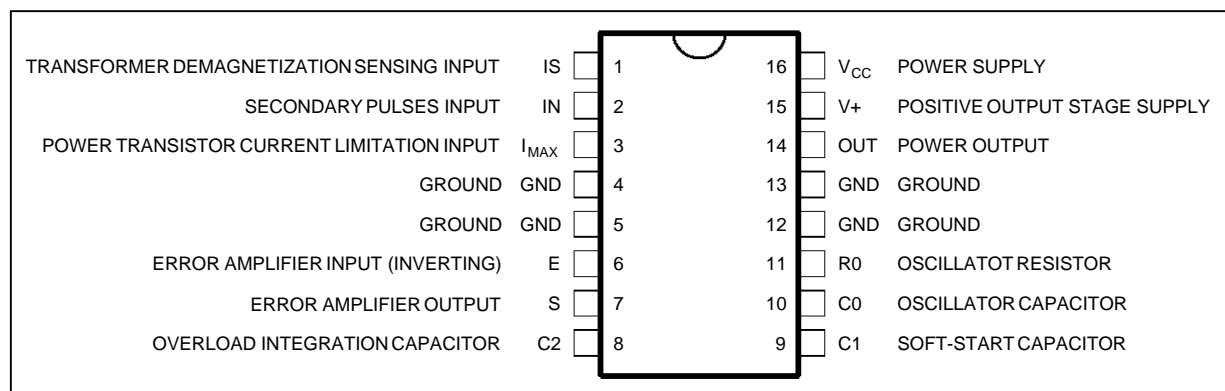

2261-01.EPS

SIMPLIFIED APPLICATION DIAGRAMS

Figure 1 : Master-slave Concept

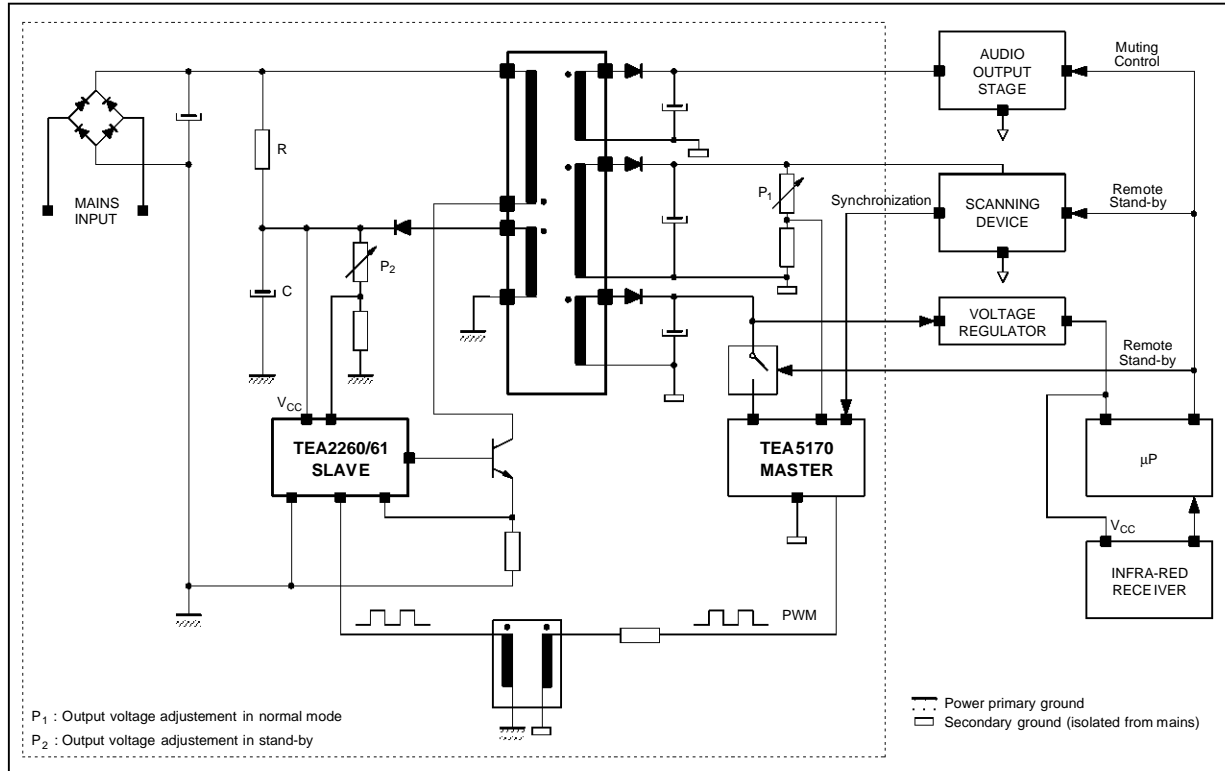

2281-02.EPS

Figure 2 : Secondary Regulation (with optocoupler)

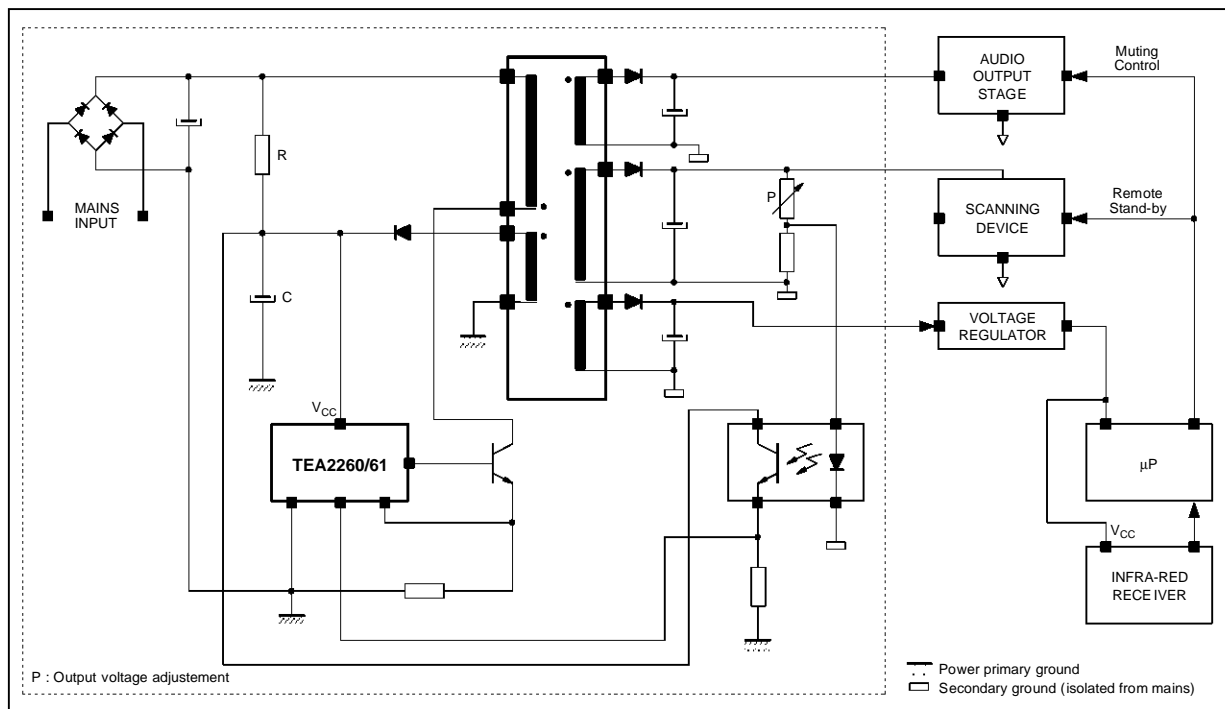

2281-03.EPS

BLOCK DIAGRAM

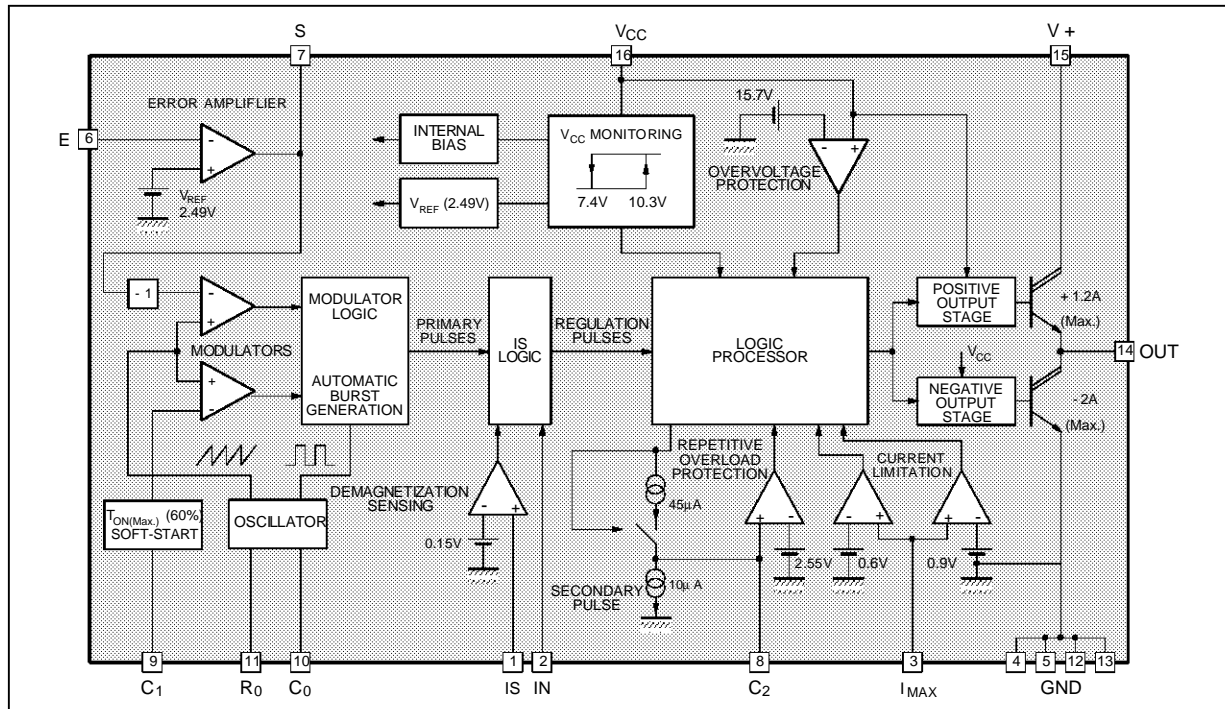

2261-04.EPS

ABSOLUTE MAXIMUM RATINGS

Symbol	Parameter	Value	Unit
V _{CC}	Power Supply V16-V4, 5, 12, 13	20	V
V+	Output Stage Power Supply V15-V4, 5, 12, 13	20	V
I _{OUT+}	Positive Output Current (source current)	1.5	A
I _{OUT-}	Negative Output Current (sink current)	2.5	A
T _j	Operating Junction Temperature	150	°C
T _{stg}	Storage Temperature Range	-40, +150	°C

2261-01.TBL

THERMAL DATA

R _{th(j-c)}	Junction-case Thermal Resistance	11	°C/W
R _{th(j-a)}	Junction-ambient Thermal Resistance	45	°C/W

* Soldered on a 35µm, 40cm² board copper area.

2261-02.TBL

MAXIMUM POWER DISSIPATION

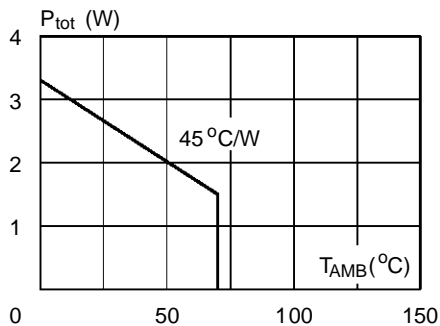

2261-05.EPS

RECOMMENDED OPERATING CONDITIONS

Symbol	Parameter	Min.	Typ.	Max.	Unit
V _{CC}	Power Supply	V _{CC stop}	12	V _{CC max}	V
I _{OUT+}	Positive Output Current (source current)			1.2	A
I _{OUT-}	Negative Output Current (sink current)			2.0	A
I _{OUT+}	Average Positive Output Current			0.6	A
I _{OUT-}	Average Negative Output Current			0.6	A
F _{oper}	Operating Frequency	10		100	kHz
V _{IN}	Input Pulses Amplitude (Pin 2)	1.5	2.5	4.5	V
R _{OSC}	Oscillator Resistor Range	20		150	kΩ
C _{OSC}	Oscillator Capacitor Range	0.47		4.7	nF
C1	Soft-starting Capacitor Range	0.047	1		μF
C2	Overload Integration Capacitor	0.047	1		μF
C2/C1	Ratio C2/C1 (C2 must be ≥ C1)	1			
T _{amb}	Operating Ambient Temperature	-20		70	°C

2261-03.TBL

ELECTRICAL CHARACTERISTICS (T_{amb} = 25°C, V_{CC} = 12V, unless otherwise specified)

Symbol	Parameter	Min.	Typ.	Max.	Unit
--------	-----------	------	------	------	------

POWER SUPPLY

V _{CC(start)}	Starting Voltage (V _{CC} increasing)	9.3	10.3	11.3	V
V _{CC(stop)}	Stopping Voltage (V _{CC} decreasing)	6.4	7.4	8.4	V
Hyst V _{CC}	Hysteresis (V _{CC(start)} - V _{CC(stop)})	2.4	2.9		V
I _{CC(start)}	Starting Current (V _{CC} = 9V)		0.7	1.4	mA
I _{CC}	Supply Current (V _{CC} = 12V)		7.5	15	mA
V _{CC(max)}	Overvoltage Threshold on V _{CC}	15	15.7		V
I _{CC(over)}	Supply Current after Overvoltage Detection (V _{CC} = 17V)	26	35	42	mA

OSCILLATOR / PWM SECTION

$\frac{\Delta F}{F}$	Accuracy (R _{OSC} = 68kΩ, C _{OSC} = 1nF)		10		%
t _{ON max}	Maximum Duty Cycle in Primary Regulation Mode	50	60	70	%

ERROR AMPLIFIER SECTION

A _{VO}	Open Loop Gain		75		dB
F _{ug}	Unity Gain Frequency		550		kHz
I _{SC}	Short Circuit Output Current (Pin 7 connected to ground)		2		mA
I _{BE}	E Input Bias Current (Pin 6)		0.08		μA
V _{REF}	Internal Voltage Reference (connected to error amplifier input and not directly accessible)	2.34	2.49	2.64	V

INPUT SECTION

V _{IN}	IN Input Threshold (Pin 2)	0.6	0.85	1.2	V
V _{IS}	IS Input Threshold (Pin 1)		0.15		V
I _{BIN}	IN Input Bias Current		0.3		μA
I _{BIS}	IS Input Bias Current		0.4		μA

CURRENT LIMITATION SECTION

V _{IM1}	First Current Limitation Threshold	558	600	642	mV
V _{IM2}	Second Current Limitation Threshold	837	900	963	mV
ΔV _{IM}	Thresholds Difference V _{IM2} - V _{IM1}		300		mV
V _{C2}	Lock-out Threshold on Pin C2	2.25	2.55	2.85	V
I _{DC2}	Capacitor C2 Discharge Current		10		μA
I _{CC2}	Capacitor C2 Charge Current		45		μA
I _{BI(max)}	Maximum Input Bias Current (Pin 3)		0.2		μA

2261-04.TBL

GENERAL DESCRIPTION

The TEA2260/61 is an off-line switch mode power supply controller. The synchronization function and the specific operation in stand-by mode make it well adapted to video applications such as TV sets, VCRs, monitors, etc...

The TEA2260/61 can be used in two types of architectures :

- Master/slave architecture. In this case, the TEA2260/61 drives the power transistor according to the pulse width modulated signals generated by the secondary located master circuit. A pulse transformer provides the feedback (see Figure 1).
- Conventional architecture with linear feedback signal (feedback sources : optocoupler or transformer winding) (see Figure 2).

Using the TEA2260/61, the stand-by auxiliary power supply, often realized with a small but costly 50Hz transformer, is no longer necessary. The burst mode operation of the TEA2260/61 makes possible the control of very low output power (down to less than 1W) with the main power transformer. When used in a master/slave architecture, the TEA2260/61 and also the power transistor turn-off can be easily synchronized with the line transformer. The switching noise cannot disturb the picture in this case.

As an S.M.P.S. controller, the TEA2260/61 features the following functions :

- Power supply start-up (with soft-start)
- PWM generator
- Direct power transistor drive (+1.2A, -2.0A)
- Safety functions : pulse by pulse current limitation, output power limitation, over and under voltage lock-out.

S.M.P.S. OPERATING DESCRIPTION

Starting Mode - Stand By Mode

Power for circuit supply is taken from the mains through a high value resistor before starting. As long as V_{CC} of the TEA2260/61 is below V_{CC} start, the quiescent current is very low (typically 0.7mA) and the electrolytic capacitor across V_{CC} is linearly charged. When V_{CC} reaches V_{CC} start (typically 10.3V), the circuit starts, generating output pulses with a soft-starting. Then the SMPS goes into the stand-by mode and the output voltage is a percentage of the nominal output voltage (eg. 80%).

For this the TEA2260/61 contains all the functions required for primary mode regulation : a fixed frequency oscillator, a voltage reference, an error amplifier and a pulse width modulator (PWM).

For transmission of low power with a good efficiency in stand-by, an automatic burst generation

system is used, in order to avoid audible noise.

Normal Mode (secondary regulation)

The normal operating of the TV set is obtained by sending to the TEA2260/61 regulation pulses generated by a regulator located in the secondary side of the power supply.

This architecture uses the "Master-slave Concept", advantages of which are now well-known especially the very high efficiency in stand-by mode, and the accurate regulation in normal mode.

Stand-by mode or normal mode are obtained by supplying or not the secondary regulator. This can be ordonned for exemple by a microprocessor in relation with the remote control unit.

Regulation pulses are applied to the TEA2260/61 through a small pulse-transformer to the IN input (Pin 2). This input is sensitive to positive square pulses. The typical threshold of this input is 0.85V. The frequency of pulses coming from the secondary regulator can be lower or higher than the frequency of the starting oscillator.

The TEA2260/61 has no soft-starting system when it receives pulses from the secondary. The soft-starting has to be located in the secondary regulator.

Due to the principle of the primary regulation, pulses generated by the starting system automatically disappear when the voltage delivered by the SMPS increases.

Stand-by Mode - Normal Mode Transition

During the transition there are simultaneously pulses coming from the primary and secondary regulators.

These signals are not synchronized and some care has to be taken to ensure the safety of the switching power transistor.

A very sure and simple way consist in checking the transformer demagnetization state.

- A primary pulse is taken in account only if the transformer is demagnetized after a conduction of the power transistor required by the secondary regulator.

- A secondary pulse is taken in account only if the transformer is demagnetized after a conduction of the power transistor required by the primary regulator.

With this arrangement the switching safety area of the power transistor is respected and there is no risk of transformer magnetization.

The magnetization state of the transformer is checked by sensing the voltage across a winding of the transformer (generally the same which supplies the TEA2261). This is made by connecting a resistor between this winding and the demagnetization sensing input of the circuit (Pin 1).

SECURITY FUNCTIONS OF THE TEA2260 (see flow-chart below)

- **Undervoltage detection.** This protection works in association with the starting device "V_{CC} switch" (see paragraph Starting-mode - standby mode). If V_{CC} is lower than V_{CCstop} (typically 7.4V) output pulses are inhibited, in order to avoid wrong operation of the power supply or bad power transistor drive.
- **Overvoltage detection.** If V_{CC} exceeds V_{CCmax} (typically 15.7V) output pulses are inhibited. Restarting of the power supply is obtained by reducing V_{CC} below V_{CCstop}.
- **Current limitation of the power transistor.** The current is measured by a shunt resistor. A double threshold system is used :
 - When the first threshold (V_{IM1}) is reached, the conduction of the power transistor is stopped until the end of the period : a new conduction signal is needed to obtain conduction again.
 - Furthermore as long as the first threshold is reached (it means during several periods), an external capacitor C₂ is charged. When the voltage across the capacitor reaches V_{C2} (typically 2.55V) the output is inhibited. This is called the "repetitive overload protection". If the overload disappears before V_{C2} is reached, C₂ is discharged, so transient overloads are tolerated.
- **Second current limitation threshold (V_{IM2}).** When this threshold is reached the output of the circuit is immediately inhibited. This protection is helpful in case of hard overload for example to avoid the magnetization of the transformer.
- **Restart of the power supply.** After stopping due to V_{C2}, V_{IM2}, V_{CCMax} or V_{CCstop} triggering, restart of the power supply can be obtained by the normal operating of the "V_{CC} switch" but thanks to an integrated counter, if normal restart cannot be obtained after three trials, the circuit is definitively stopped. In this case it is necessary to reduce V_{CC} below approximately 5V to reset the circuit. From a practical point of view, it means that the power supply has to be temporarily disconnected from any power source to get the restart.

SECURITY FLOW-CHART (TEA2260)

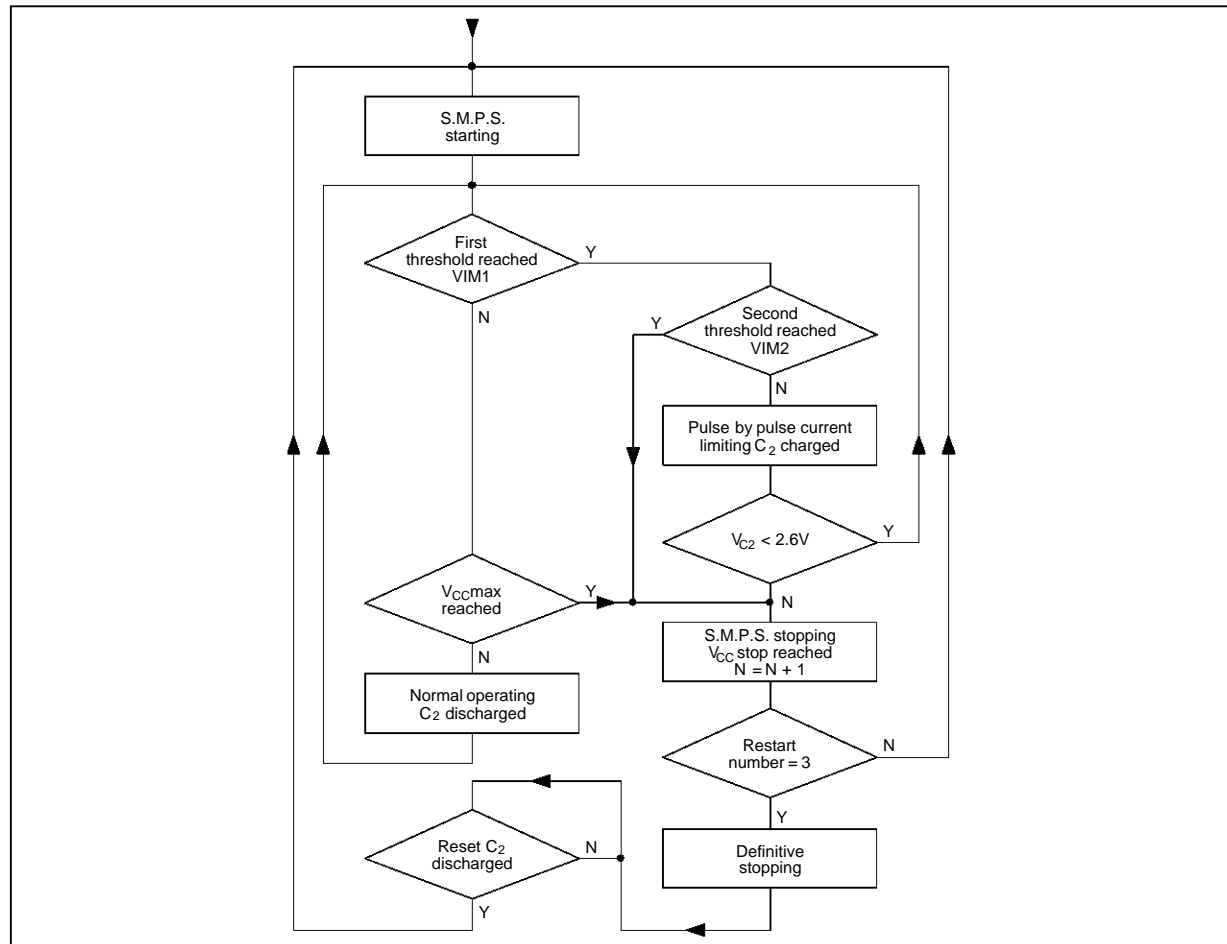

2261-06-EPS

SECURITY FUNCTIONS OF THE TEA2261 (see flow-chart below)

- **Undervoltage detection.** This protection works in association with the starting device "V_{CC} switch" (see paragraph Starting-mode - standby mode). If V_{CC} is lower than V_{CCstop} (typically 7.4V) output pulses are inhibited, in order to avoid wrong operation of the power supply or bad power transistor drive.
- **Overvoltage detection.** If V_{CC} exceeds V_{CCmax} (typically 15.7V) output pulses are inhibited and the external capacitor C₂ is charged as long as V_{CC} is higher than V_{CC stop}. Restarting of the power supply is obtained by reducing V_{CC} below V_{CCstop} except if the voltage across C₂ reaches V_{C2} (typically 2.55V) (refer to "Restart of the power supply" paragraph). In this last case, the circuit is definitively stopped.
- **Current limitation of the power transistor.** The current is measured by a shunt resistor. A double threshold system is used :
 - When the first threshold (V_{IM1}) is reached, the conduction of the power transistor is stopped until the end of the period : a new conduction signal is needed to obtain conduction again.
 - Furthermore as long as the first threshold is reached (it means during several periods), an external capacitor C₂ is charged. When the voltage across the capacitor reaches V_{C2} (typically 2.55V) the output is inhibited. This is called the "repetitive overload protection". If the overload disappears before V_{C2} is reached, C₂ is discharged, so transient overloads are tolerated.
- **Second current limitation threshold (V_{IM2}).** When this threshold is reached the output of the circuit is immediately inhibited. This protection is helpful in case of hard overload for example to avoid the magnetization of the transformer.
- **Restart of the power supply.** After stopping due to V_{IM2}, V_{CCMax} or V_{CCstop} triggering, restart of the power supply can be obtained by the normal operating of the "V_{CC} switch" V_{CC} switch sequency from V_{CCstop} to V_{CCstart}. After stopping due to V_{C2} threshold reaching, the circuit is definitively stopped. In this case it is necessary to reduce V_{CC} below approximately 5V to reset the circuit. From a practical point of view, it means that the power supply has to be temporarily disconnected from any power source to get the restart.

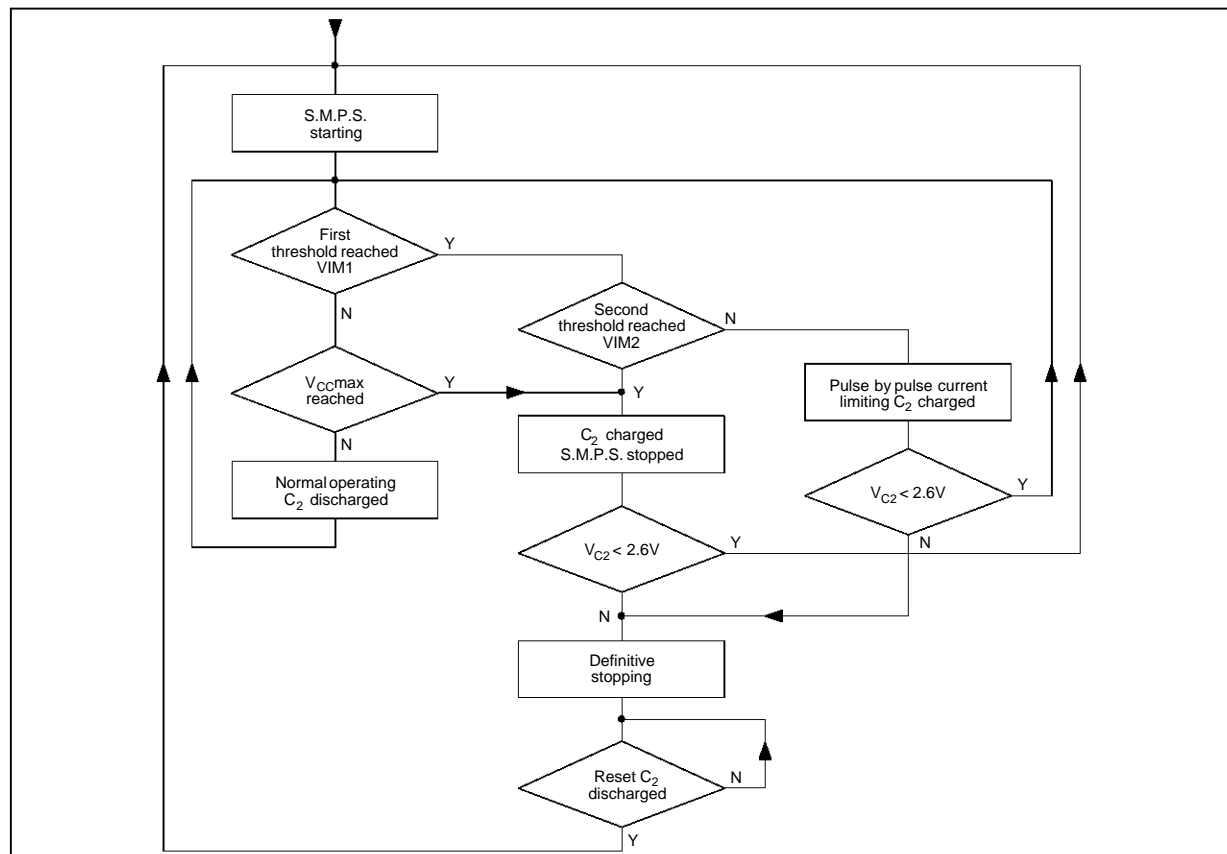
SECURITY FLOW-CHART (TEA2261)

2261-07.EPS

TEA2260 - TEA2261

TYPICAL APPLICATION (Master/slave architecture)

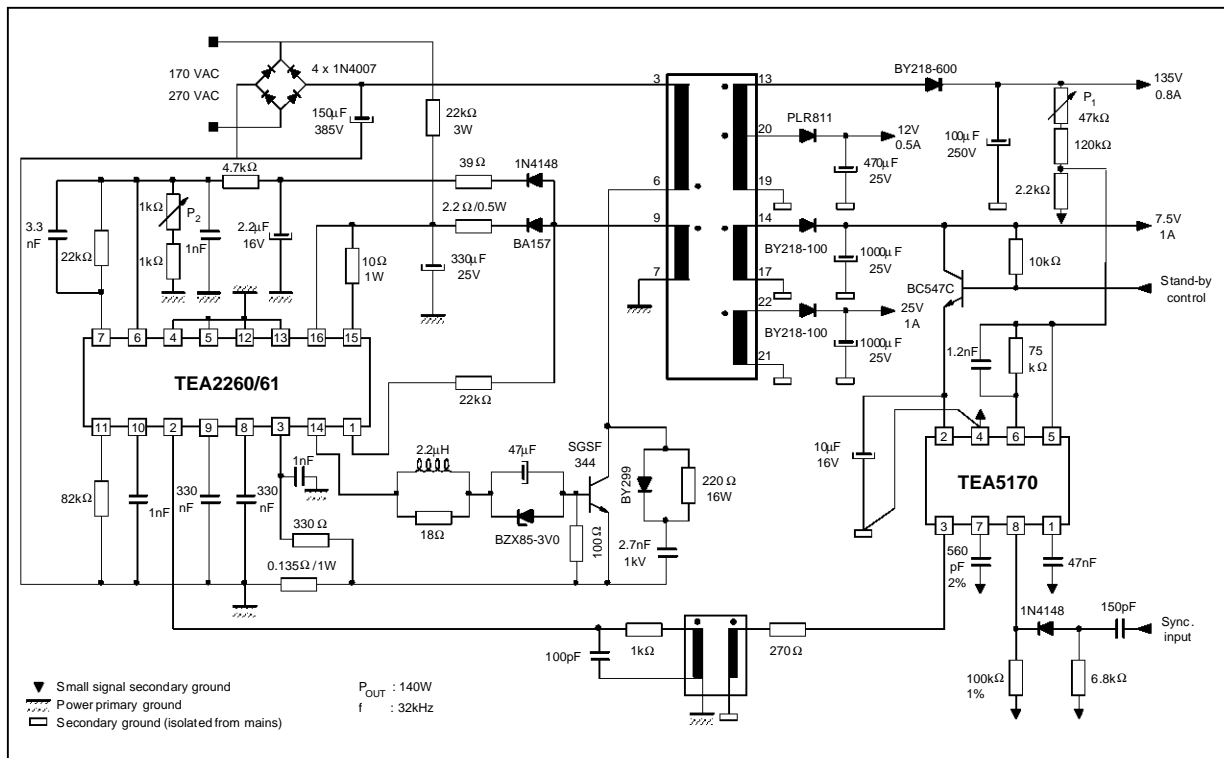

2261-08.EPS

TV - SET SMPS (with TEA5170)

Input voltage range	170VAC – 270VAC
Input DC voltage range	210VDC – 370VDC
Output power in normal mode	$25W < P_O < 140W$
Output power in stand by mode	$2W < P_O < 45W$
Operating frequency	32 kHz
Efficiency at full load	> 80%
Efficiency in stand by mode	> 50%
Short circuit protected	
Open load protected	
Long duration overload protected	
Complete shutdown after repetitive default detection	

Load regulation (VDC = 310V)

Output 135V ($\pm 0.18\%$)	$\rightarrow (I_{135} : 0.01A \text{ to } 0.8A ; I_{25} = 1A)$
Output 25V ($\pm 2\%$)	$\rightarrow (I_{135} : 0.8A ; I_{25} : 0.5A \rightarrow 1A)$

Line regulation

Output 135V ($\pm 0.13\%$)	$\rightarrow (210V < V_{DC} < 370V)$
Output 25V ($\pm 0.17\%$)	$\rightarrow (I_{135} : 0.8A ; I_{25} : 1A)$

PACKAGE MECHANICAL DATA
16 PINS - PLASTIC DIP

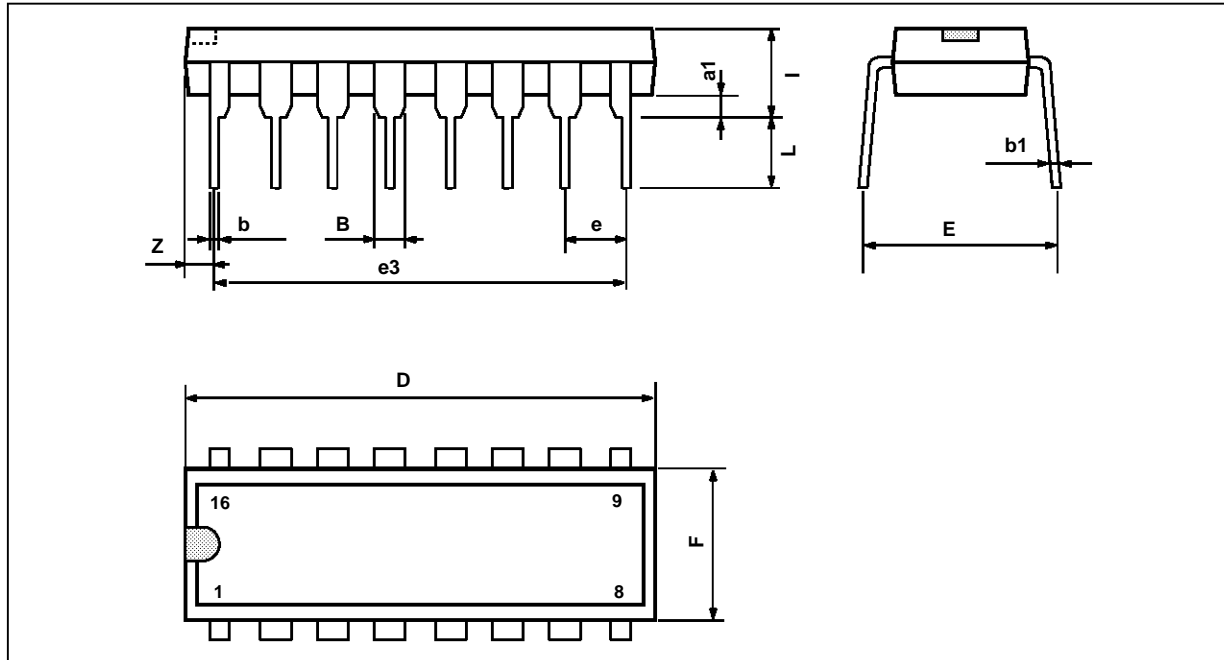

PM-DIP16.EPS

Dimensions	Millimeters			Inches		
	Min.	Typ.	Max.	Min.	Typ.	Max.
a1	0.51			0.020		
B	0.77		1.65	0.030		0.065
b		0.5			0.020	
b1		0.25			0.010	
D			20			0.787
E		8.5			0.335	
e		2.54			0.100	
e3		17.78			0.700	
F			7.1			0.280
i			5.1			0.201
L		3.3			0.130	
Z			1.27			0.050

DIP16.TBL

Information furnished is believed to be accurate and reliable. However, SGS-THOMSON Microelectronics assumes no responsibility for the consequences of use of such information nor for any infringement of patents or other rights of third parties which may result from its use. No licence is granted by implication or otherwise under any patent or patent rights of SGS-THOMSON Microelectronics. Specifications mentioned in this publication are subject to change without notice. This publication supersedes and replaces all information previously supplied. SGS-THOMSON Microelectronics products are not authorized for use as critical components in life support devices or systems without express written approval of SGS-THOMSON Microelectronics.

© 1994 SGS-THOMSON Microelectronics - All Rights Reserved

Purchase of I²C Components of SGS-THOMSON Microelectronics, conveys a license under the Philips I²C Patent. Rights to use these components in a I²C system, is granted provided that the system conforms to the I²C Standard Specifications as defined by Philips.

SGS-THOMSON Microelectronics GROUP OF COMPANIES

Australia - Brazil - China - France - Germany - Hong Kong - Italy - Japan - Korea - Malaysia - Malta - Morocco
The Netherlands - Singapore - Spain - Sweden - Switzerland - Taiwan - Thailand - United Kingdom - U.S.A.