

**Major Ratings and Characteristics**

Characteristics	10BQ100	Units
$I_{F(AV)}$ Rectangular waveform	1.0	A
$V_{RRM}$	100	V
$I_{FSM}$ @tp=5 $\mu$ s sine	780	A
$V_F$ @1.0Apk, $T_J=125^\circ\text{C}$	0.62	V
$T_J$ range	-55 to 175	$^\circ\text{C}$

**Description/Features**

The 10BQ100 surface-mount Schottky rectifier has been designed for applications requiring low forward drop and very small foot prints on PC boards. Typical applications are in disk drives, switching power supplies, converters, free-wheeling diodes, battery charging, and reverse battery protection.

- Small foot print, surface mountable
- Low forward voltage drop
- High frequency operation
- Guard ring for enhanced ruggedness and long term reliability

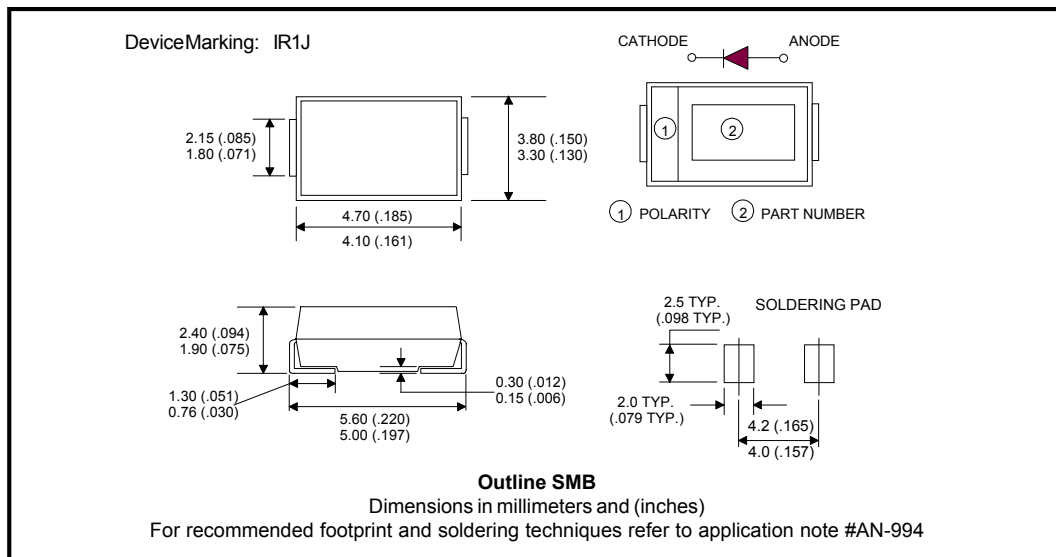

# 10BQ100

Bulletin PD-2.497 rev. D 02/02

International  
**IR** Rectifier

## Voltage Ratings

Part number	10BQ100
$V_R$ Max. DC Reverse Voltage (V)	100
$V_{RWM}$ Max. Working Peak Reverse Voltage (V)	

## Absolute Maximum Ratings

Parameters	10BQ	Units	Conditions
$I_{F(AV)}$ Max. Average Forward Current	1.0	A	50% duty cycle @ $T_L = 152^\circ\text{C}$ , rectangular waveform
$I_{FSM}$ Max. Peak One Cycle Non-Repetitive Surge Current	780	A	5 $\mu\text{s}$ Sine or 3 $\mu\text{s}$ Rect. pulse
	38		10ms Sine or 6ms Rect. pulse
$E_{AS}$ Non-Repetitive Avalanche Energy	3	mJ	$T_J = 25^\circ\text{C}$ , $I_{AS} = 1.0\text{A}$ , $L = 10\text{mH}$
$I_{AR}$ Repetitive Avalanche Current	0.2	A	Current decaying linearly to zero in 1 $\mu\text{sec}$ Frequency limited by $T_J$ max. $V_a = 1.5 \times V_r$ typical

## Electrical Specifications

Parameters	10BQ	Units	Conditions
$V_{FM}$ Max. Forward Voltage Drop (1) * See Fig. 1	0.78	V	@ 1A
	0.89	V	@ 2A
	0.62	V	@ 1A
	0.72	V	@ 2A
$I_{RM}$ Max. Reverse Leakage Current (1) * See Fig. 2	0.5	mA	$T_J = 25^\circ\text{C}$
	1	mA	$T_J = 125^\circ\text{C}$
$C_T$ Typical Junction Capacitance	42	pF	$V_R = 5V_{DC}$ , (test signal range 100kHz to 1MHz) $25^\circ\text{C}$
$L_S$ Typical Series Inductance	2.0	nH	Measured lead to lead 5mm from package body
$dv/dt$ Max. Voltage Rate of Charge (Rated $V_R$ )	10000	V/ $\mu\text{s}$	

(1) Pulse Width < 300 $\mu\text{s}$ , Duty Cycle < 2%

## Thermal-Mechanical Specifications

Parameters	10BQ	Units	Conditions
$T_J$ Max. Junction Temperature Range (*)	-55 to 175	$^\circ\text{C}$	
$T_{stg}$ Max. Storage Temperature Range	-55 to 175	$^\circ\text{C}$	
$R_{thJL}$ Max. Thermal Resistance Junction to Lead (**)	36	$^\circ\text{C}/\text{W}$	DC operation
$R_{thJA}$ Max. Thermal Resistance Junction to Ambient	80	$^\circ\text{C}/\text{W}$	
wt Approximate Weight	0.10(0.003)	g(oz.)	
Case Style	SMB		Similar DO-214AA
Device Marking	IR1J		

(\*)  $\frac{dP_{tot}}{dT_J} < \frac{1}{R_{th(j-a)}}$  thermal runaway condition for a diode on its own heatsink

(\*\*) Mounted 1 inch square PCB

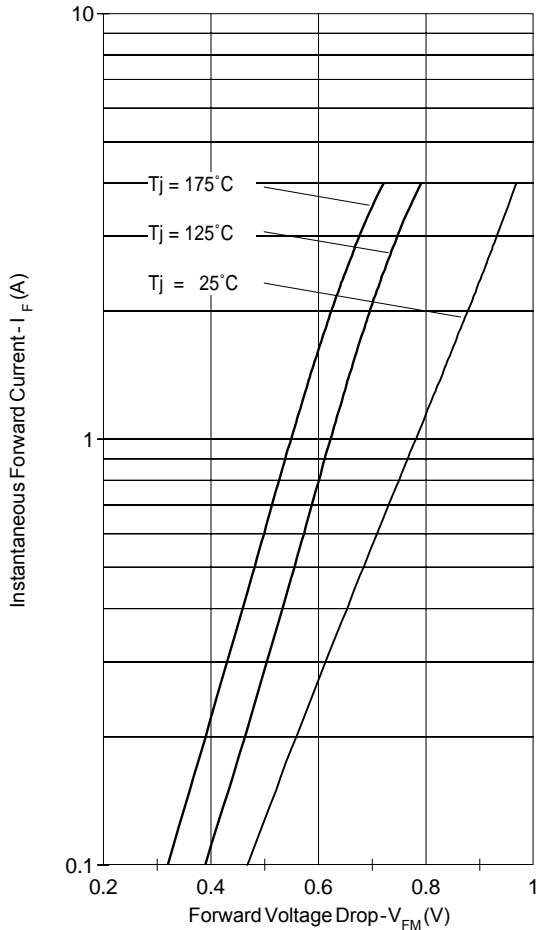

Fig. 1 - Maximum Forward Voltage Drop Characteristics

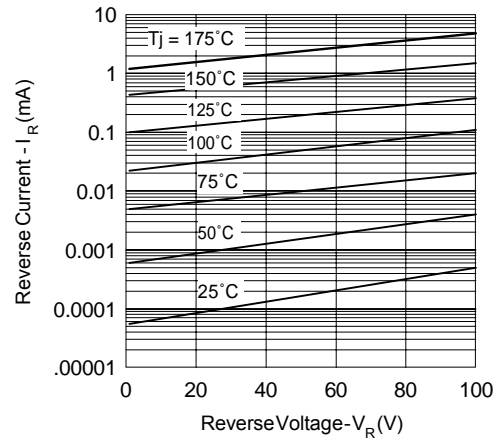

Fig. 2 - Typical Peak Reverse Current Vs. Reverse Voltage

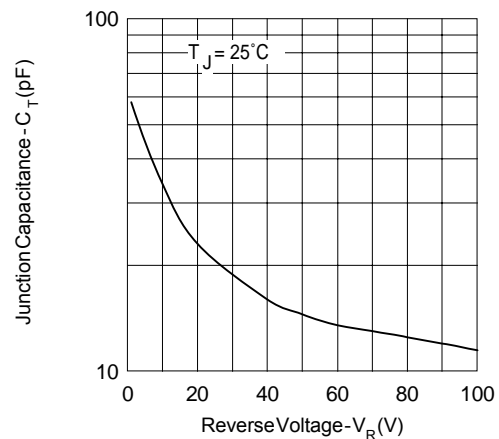

Fig. 3 - Typical Junction Capacitance Vs. Reverse Voltage

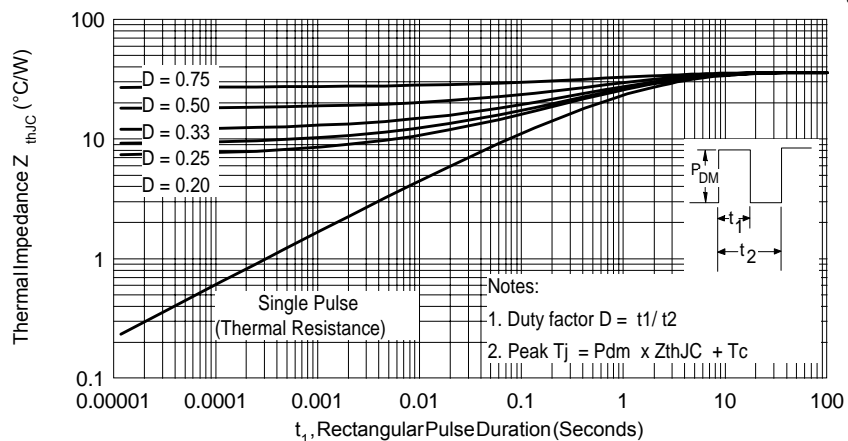

Fig. 4 - Max. Thermal Impedance  $Z_{thJC}$  Characteristics (Per Leg)

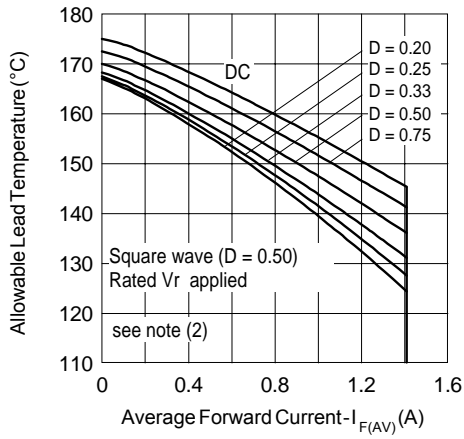

Fig. 4- Maximum Average Forward Current Vs. Allowable Lead Temperature

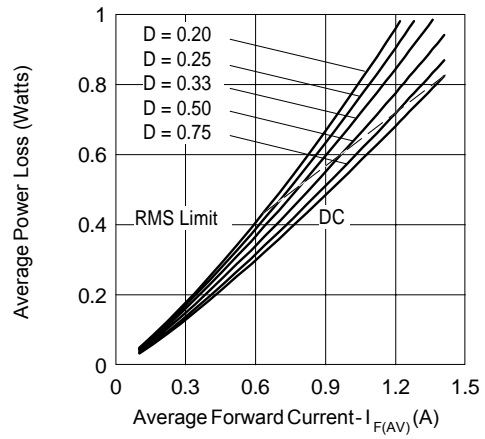

Fig. 5- Maximum Average Forward Dissipation Vs. Average Forward Current

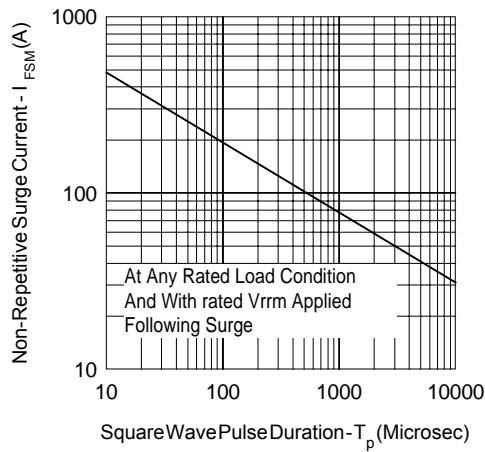

Fig. 6- Maximum Peak Surge Forward Current Vs. Pulse Duration

(2) Formula used:  $T_c = T_j - (Pd + Pd_{REV}) \times R_{thJC}$ ;

$Pd$  = Forward Power Loss =  $I_{F(AV)} \times V_{FM} @ (I_{F(AV)} / D)$  (see Fig. 6);

$Pd_{REV}$  = Inverse Power Loss =  $V_{R1} \times I_{R1} (1 - D)$ ;  $I_{R1} @ V_{R1} = 80\%$  rated  $V_R$

**Tape & Reel Information**

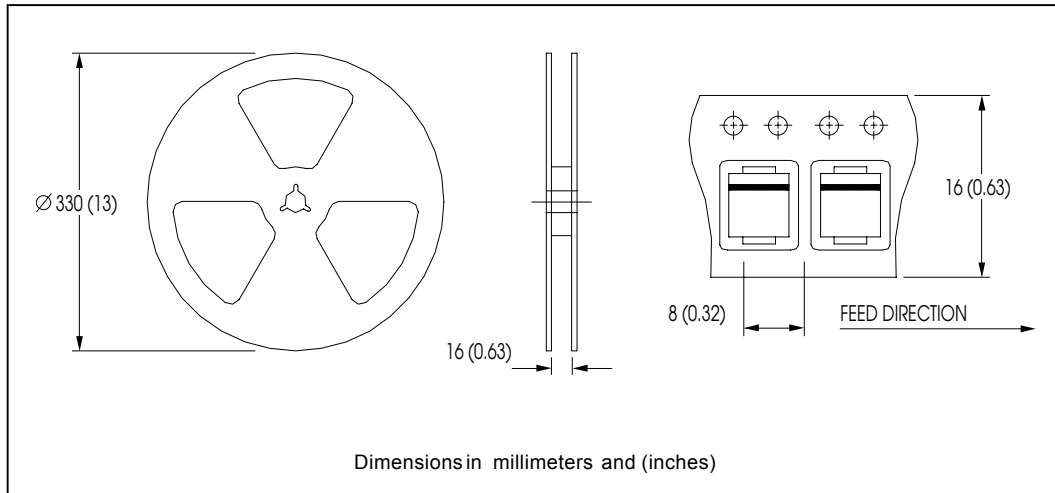

**Marking & Identification**

**Ordering Information**

Each device has 8 characters, configured 4 digits on two rows, for identification. The first row designates the device as manufactured by International Rectifier as indicated by the letters "IR", and the Part Number (indicates the current rating and voltage/process). The second row indicates the year and the week of manufacturing.

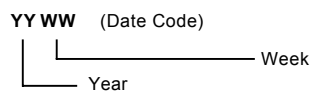
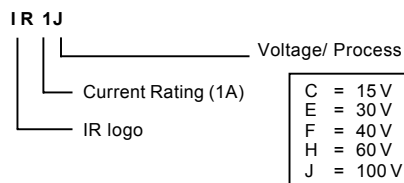
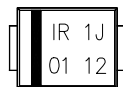

**10BQ SERIES - TAPE AND REEL**

WHEN ORDERING, INDICATE THE PART NUMBER AND THE QUANTITY ( IN MULTIPLES OF 3000 PIECES).

EXAMPLE: 10BQ100TR-6000PIECES

**10BQ SERIES - BULK QUANTITIES**

WHEN ORDERING, INDICATE THE PART NUMBER AND THE QUANTITY ( IN MULTIPLES OF 1000 PIECES).

EXAMPLE: 10BQ100 - 2000PIECES

10BQ100

Bulletin PD-2.497 rev. D 02/02

International  
**IR** Rectifier

---

Data and specifications subject to change without notice.  
This product has been designed and qualified for Industrial Level.  
Qualification Standards can be found on IR's Web site.

International  
**IR** Rectifier

**IR WORLD HEADQUARTERS:** 233 Kansas St., El Segundo, California 90245, USA Tel: (310) 252-7105  
TAC Fax: (310) 252-7309  
Visit us at [www.irf.com](http://www.irf.com) for sales contact information. 02/02