

# AN7465K/S

## FM Noise Canceller/Stereo Multiplex Demodulator for Car Radio

### ■ Description

The AN7465K/S are the monolithic integrated circuits for car stereo configured FM noise canceller and PLL multiplex demodulator in a single chip.

### ■ Features

- HPF/LPF of noise canceller input section built-in
- Good S/N and distortion due to use of quasi sine wave as pilot canceller negative wave
- HPF band auto switching by monaural and stereo
- With ASC/ATC functions reducing noise at weak electric field smoothly
- With forced monaural and VCO stop

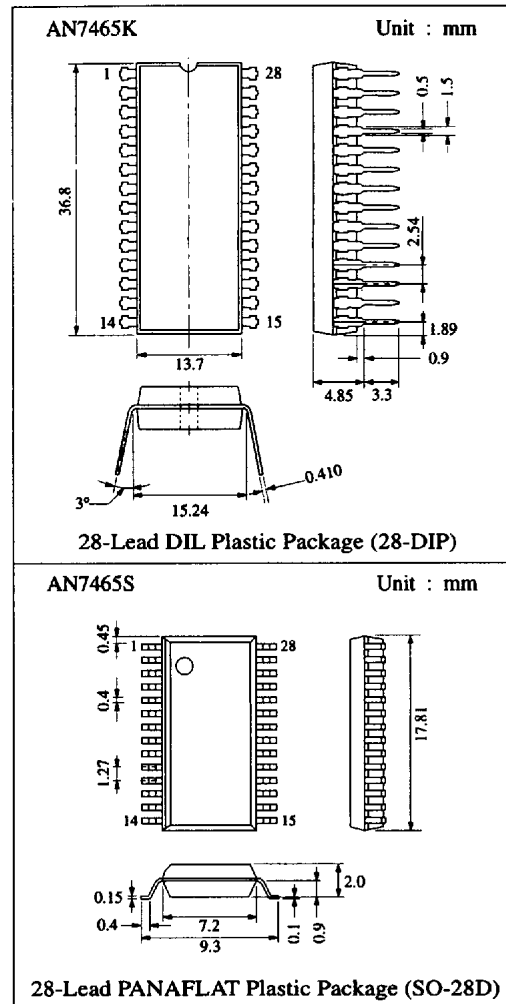

### ■ Block Diagram

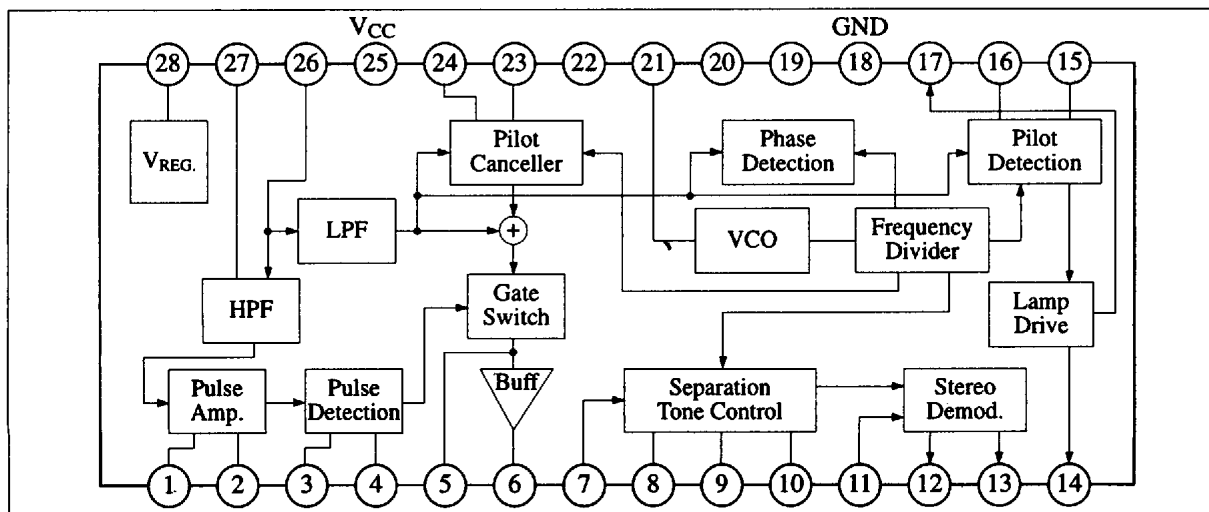

### ■ Absolute Maximum Ratings (Ta=25°C)

Item	Symbol	Rating	Unit
Supply Voltage	V <sub>CC</sub>	10	V
Supply Current (Without Lamp)	I <sub>CC(1)</sub>	25	mA
Supply Current (With lamp)	I <sub>CC(2)</sub>	30	mA
Power Dissipation	P <sub>D</sub>	280	mW
Operating Ambient Temperature	Topr	-30 ~ +75	°C
Storage Temperature	Tstg	-55 ~ +125	°C

Operating Supply Voltage Range: V<sub>CC</sub> = 6.0V ~ 10.0V

### ■ Electrical Characteristics (Ta=25°C)

Item	Symbol	Condition	min.	typ.	max.	Unit
Total Circuit Current	I <sub>tot</sub>	V <sub>in</sub> = 0mV	10	15	20	mA
AGC Voltage (1)	V <sub>AGC1</sub>	V <sub>in</sub> = 0mV, R <sub>s</sub> = 10kΩ		0.05	0.4	V
AGC Voltage (2)	V <sub>AGC2</sub>	V <sub>in</sub> = 2mV, f = 150kHz	1	1.3	1.5	V
Noise Detection Voltage	V <sub>DET</sub>	V <sub>in</sub> = 100mV, f = 150kHz		0.05	0.3	V
Gate Pulse Width	PW	V <sub>in</sub> = 0.3V <sub>p-p</sub> Pulse, t <sub>w</sub> = 1μs, f = 1kHz	20	25	30	μs
Residual Noise Voltage	V <sub>NR</sub> *	V <sub>in</sub> = 1V <sub>p-p</sub> Pulse*, t <sub>w</sub> = 10μs, f = 1kHz		0.3	0.7	mV
Output Voltage	V <sub>O</sub>	V <sub>in</sub> = 300mV, f = 1kHz	250	290	330	mV
Channel Balance	CB	V <sub>in</sub> = 300mV, f = 1kHz		0	1	dB
Separation (1) (R9 = 820Ω fixed)	Sep <sub>1</sub>	V <sub>(L+R)</sub> = 270mV, V <sub>p</sub> = 30mV, f = 1kHz	22	32		dB
Separation (2) (at R9 adjustment)	Sep <sub>2</sub>	At V <sub>(L+R)</sub> = 270mV, V <sub>p</sub> = 30mV, f = 1kHz, Adjustment		40		dB
Total Harmonic Distortion (Stereo)	THD	V <sub>(L+R)</sub> = 270mV, V <sub>p</sub> = 30mV, f = 1kHz		0.05	0.3	%
Total Harmonic Distortion (Mono)	THD	V <sub>in</sub> = 300mV, f = 1kHz		0.05	0.3	%
Residual Pilot Voltage	V <sub>PC</sub>	V <sub>p</sub> = 30mV		2.5	10	mV
Lamp ON Pilot Voltage	V <sub>p(ON)</sub>	Input only Pilot Signal	11	16	21	mV
Lamp OFF Pilot Voltage	V <sub>p(OFF)</sub>	Input only Pilot Signal		8		mV
Capture Range	CR	V <sub>p</sub> = 30mV	±1.8	±3		%
VCO Stop Voltage	V <sub>14-18</sub>	Pin 14, VCO Stop Voltage	3	3.4	3.8	V
Maximum Input Voltage	V <sub>in(max)</sub>	f = 1kHz, Input at lamp ON	0.7			V
Input Impedance	Z <sub>in</sub>	Pin 26		53		kΩ
Output Impedance	Z <sub>O</sub>	Pin 12, 13		3.3		kΩ

\* Input through LPF of R = 150Ω, C = 0.033μF

■ Application Circuit

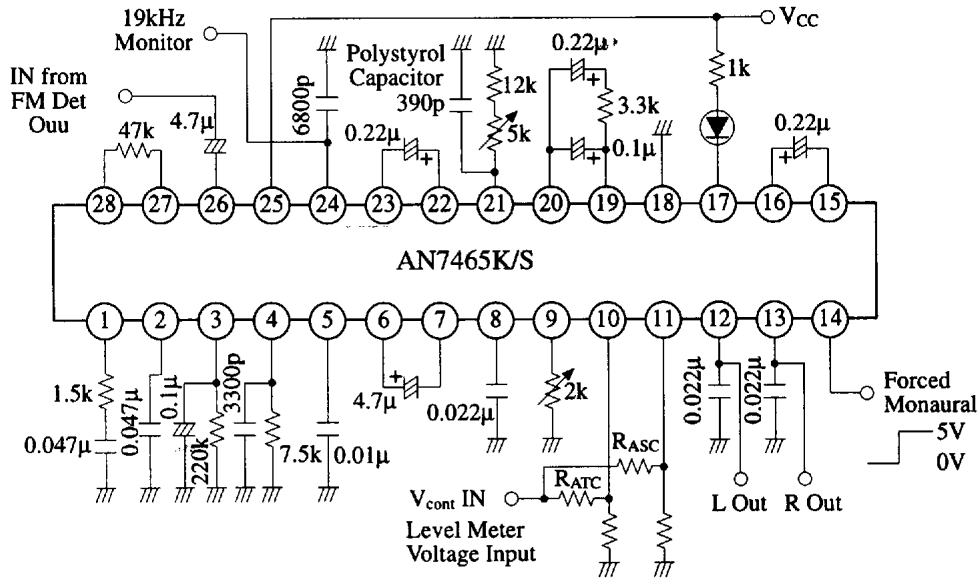

Note: R<sub>ATC</sub> and R<sub>ASC</sub> must be determined by size of level meter.  
When user use half-fixed VR; use 100kΩ

■ Pin Descriptions

Pin No.	Pin Name	Pin Waveform, Voltage	I/O Impedance	Equivalent Circuit
1	AGC Amp. LPF	2.5V	6.2kΩ	
2	Pulse Amp. LPF	1.8V	2.7kΩ	
3	Noise Amp. AGC	0V to 2.5V Noise level	At charge ... 15kΩ At discharge ... High	
4	Gate Time Adj.	0V to 2.5V <sub>max</sub> Normal	Usually High Low at operation	
5	NC. Hold	V <sub>(AC)</sub> = V <sub>in</sub> - V <sub>p</sub> V <sub>(DC)</sub> ≈ 2.5V	1.5kΩ	
6	NC. OUT	DC 1.2V	1kΩ	
7	MPX. IN	V <sub>(AC)</sub> = V <sub>in</sub> - V <sub>p</sub>	33kΩ	

■ Pin Descriptions (Continue)

Pin No.	Pin Name	Pin Waveform, Voltage	I/O Impedance	Equivalent Circuit																				
8	ATC LPF	High level down $V_{(DC)} \approx 1.9V$	5.1kΩ																					
9	Separation Adj.	$DC_{(max)} \approx 1.2V$ $AC = 0 \sim V_7$	2kΩ																					
10	ATC	Input level meter output voltage	High																					
11	ASC	Input level meter output voltage	High																					
12	L-ch. OUT		3.3kΩ																					
13	R-ch. OUT		3.3kΩ																					
14	ST/MONO Control	<table border="1"> <thead> <tr> <th>Pin Voltage</th> <th>Demod.</th> <th>LED</th> <th>Pilot Can.</th> <th>VCO</th> </tr> </thead> <tbody> <tr> <td>0-1V</td> <td>0</td> <td>0</td> <td>0</td> <td>0</td> </tr> <tr> <td>1.7-3.2V</td> <td>X</td> <td>X</td> <td>0</td> <td>0</td> </tr> <tr> <td>3.9-V<sub>CC</sub></td> <td>X</td> <td>X</td> <td>X</td> <td>X</td> </tr> </tbody> </table>	Pin Voltage	Demod.	LED	Pilot Can.	VCO	0-1V	0	0	0	0	1.7-3.2V	X	X	0	0	3.9-V <sub>CC</sub>	X	X	X	X	High	
Pin Voltage	Demod.	LED	Pilot Can.	VCO																				
0-1V	0	0	0	0																				
1.7-3.2V	X	X	0	0																				
3.9-V <sub>CC</sub>	X	X	X	X																				
15	Pilot Detection LPF	DC ≈ 2.5V	≈ 14kΩ																					
16	Pilot Detection LPF	DC = 2.5V	≈ 14kΩ																					
17	LED Driver	At Stereo DC ≈ 0.7V ~ 1V	Low																					
		At Monaural Determined by external voltage	High																					
18	GND	0V	Low																					
19	PLL LPF	DC 2.5V	≈ 11kΩ																					
20	PLL LPF	DC 2.5V	≈ 11kΩ																					

■ Pin Descriptions (Continue)

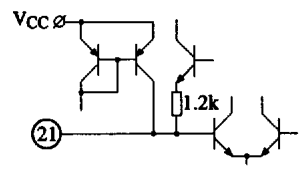
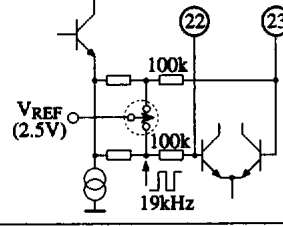
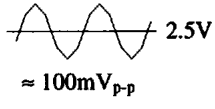
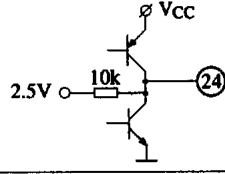
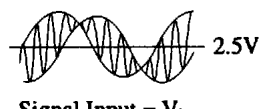
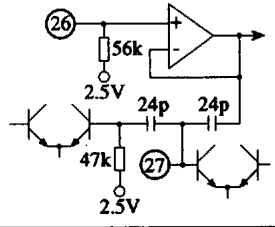
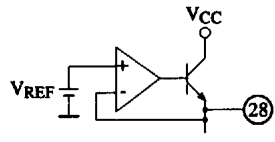
Pin No.	Pin Name	Pin Waveform, Voltage	I/O Impedance	Equivalent Circuit
21	VCO RCC Time Constant		1.2kΩ	
22	Pilot Cancellor Control LPF	DC 2.5V	≈ 100kΩ	
23	Pilot Cancellor Control LPF	DC 2.5V	≈ 100kΩ	
24	Pilot Cancellor Quasi Sine			
25	V <sub>CC</sub>	DC 8V	Low	
26	NC. IN	 Signal Input = V <sub>in</sub>	56kΩ	
27	NC. HPF	Low level down DC is determined by external voltage (2.5V)	High	
28	V <sub>REF</sub>	2.5V constant voltage	Low	

■ Characteristics Curve

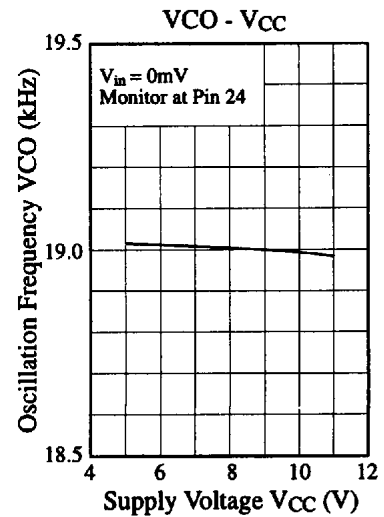
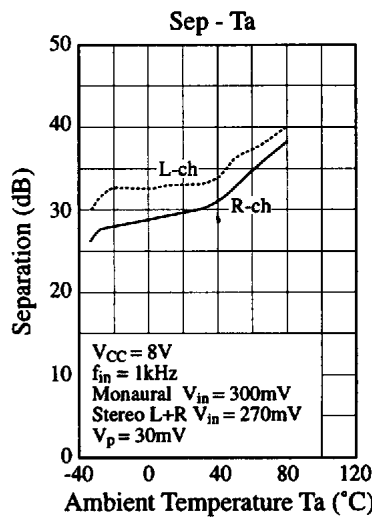
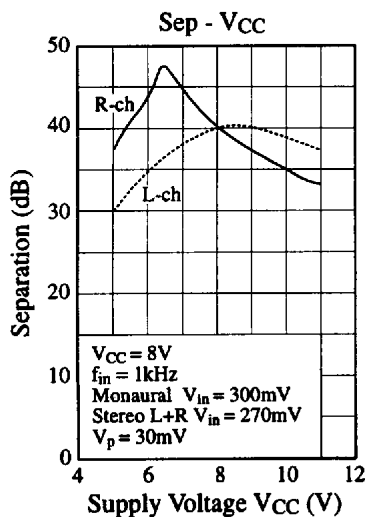

■ Characteristics Curve (Continue)

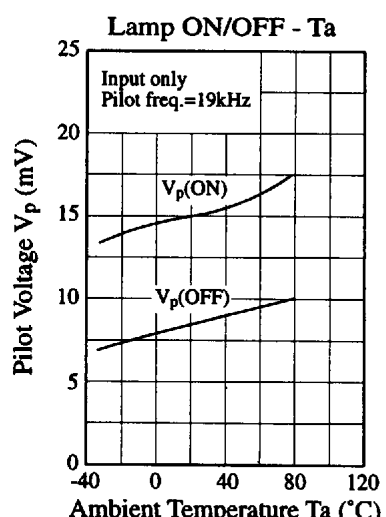
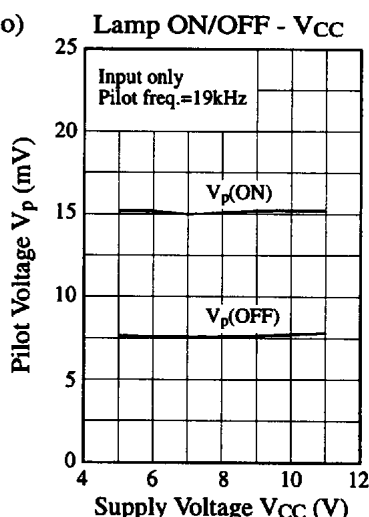
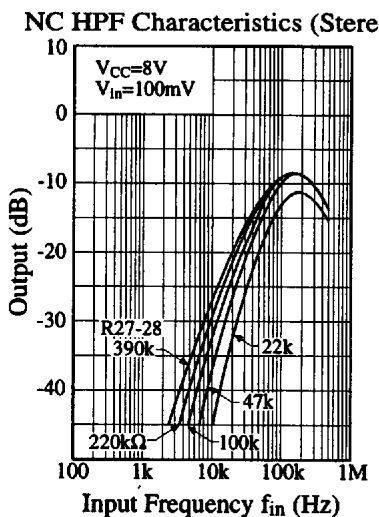
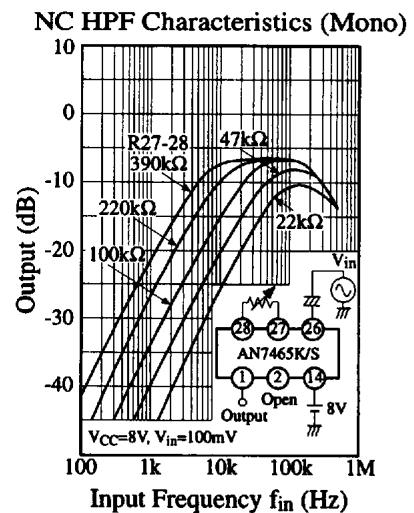
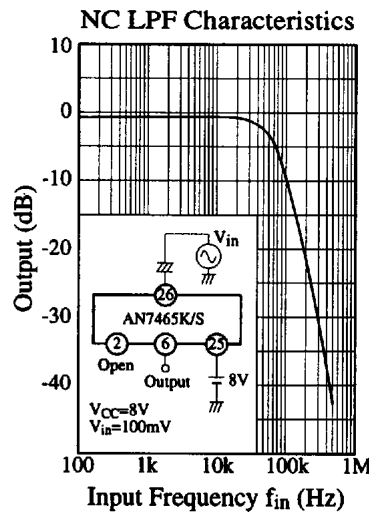
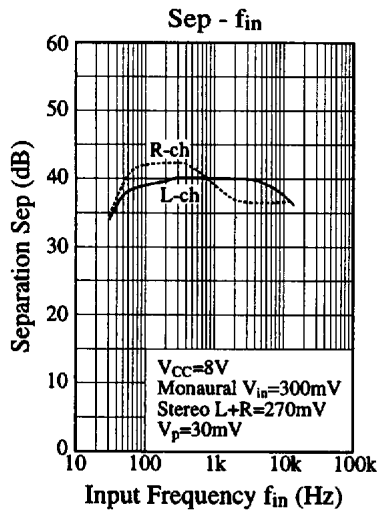
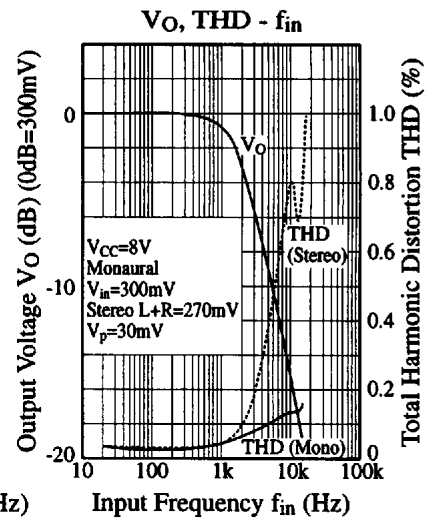
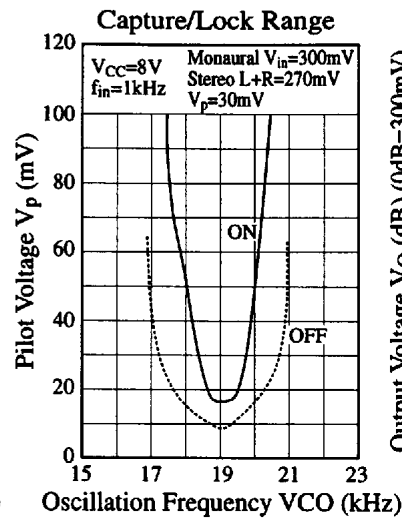
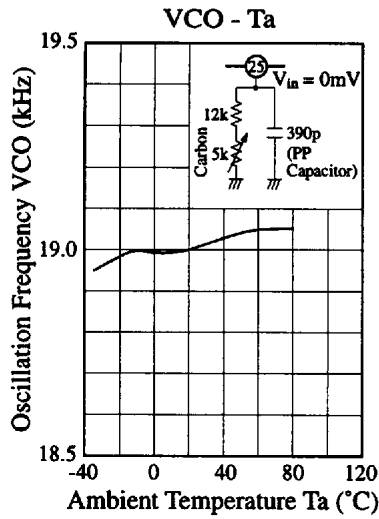

■ Characteristics Curve (Continue)

Forced Monaural ON Level -  $V_{CC}$

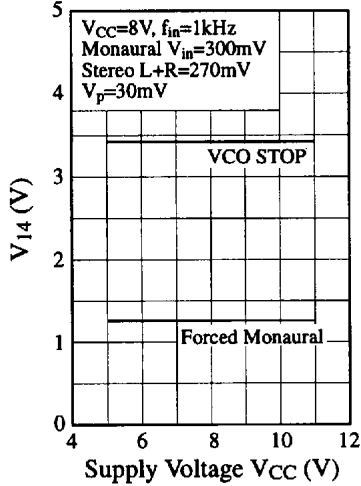

Forced Monaural ON Level -  $T_a$

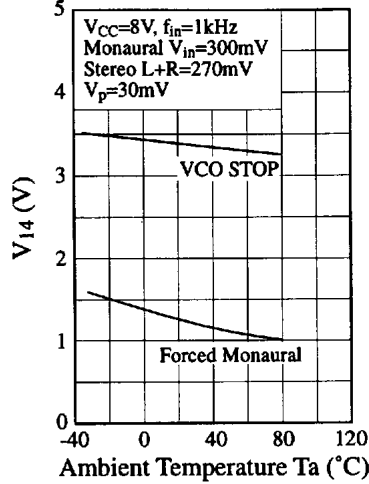

NC Gate Pulse Width -  $V_{CC}$

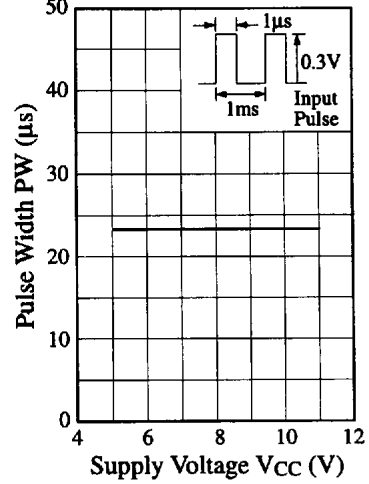

NC Gate Pulse Width -  $T_a$

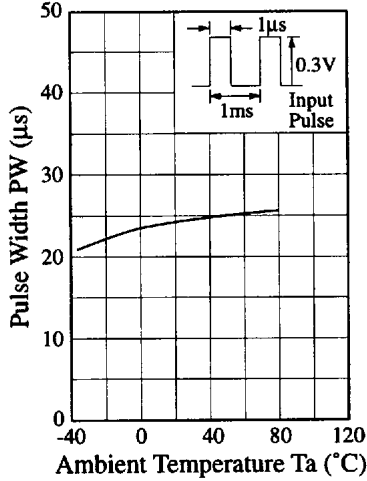

$I_{tot}$  -  $T_a$

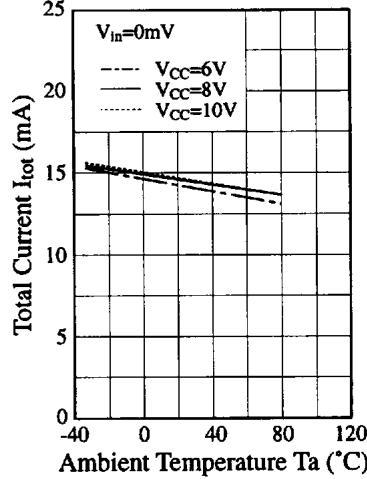

$V_{REF}$  -  $T_a$

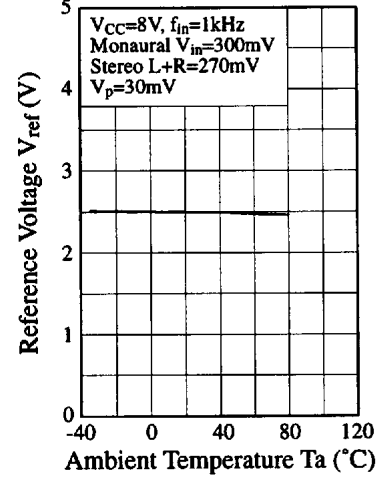

$V_{out}$  -  $f_{in}$

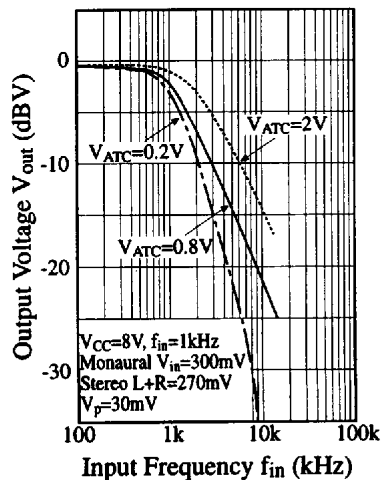

ASC Characteristics

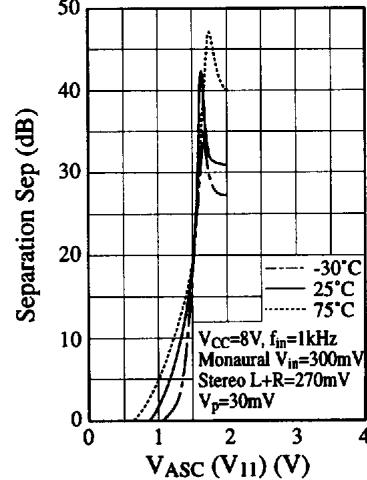

ATC Characteristics

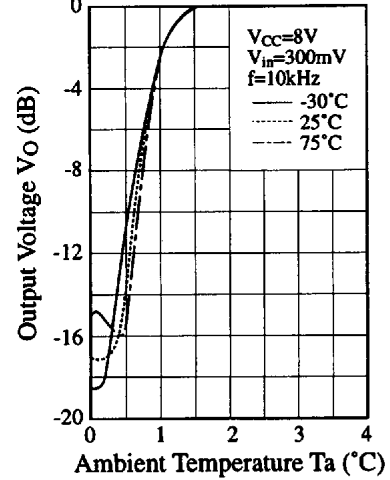

## ■ Characteristics Curve (Continue)

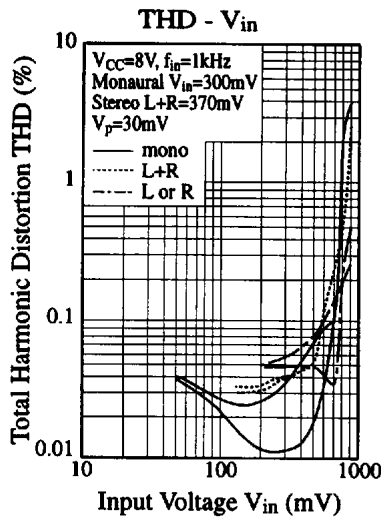

## ■ Supplementary Explanation

### ● Selection Standard of Noise Canceller Resistance Value

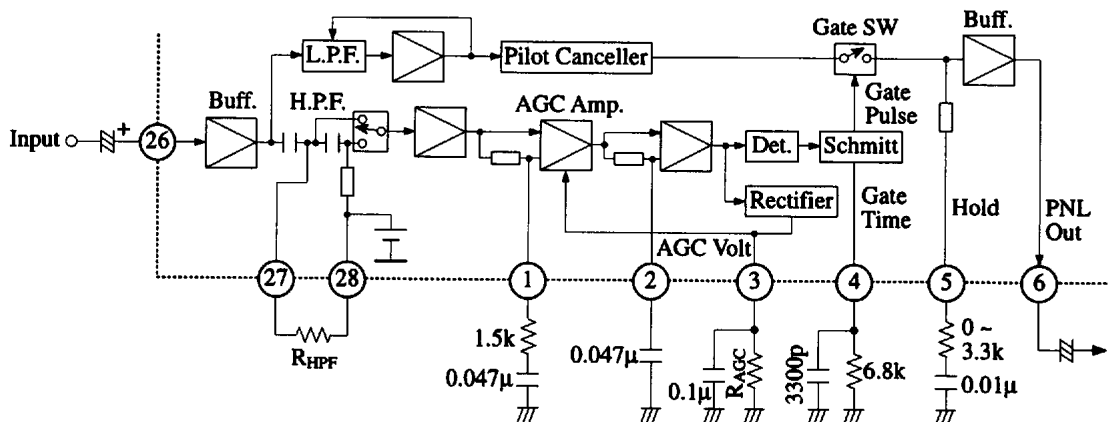

Fig. 1 Pulse Noise Eliminator (PNL) Block Diagram

#### (1) Relation to field strength

1. In weak electric field where noise is apt to increase, the AGC effectively controls the PNL operation.
  - (a) In case operation error is frequently caused by white noise  
Suitably increase the value of Pin 3  $R_{AGC}$ . ( $220k\Omega \sim 1M\Omega$ )
  - (b) In case operation error is frequently caused by overmodulation  
Suitably increase the value of  $R_{HPF}$  between Pin 27 and Pin 28. ( $47k\Omega \sim 470k\Omega$ )
2. In medium to strong electric field relatively free from noise generation, the AGC becomes less effective and noise is detected almost at the maximum sensitivity.
  - (a) In case the detection sensitivity is too high  
Suitably decrease the value of  $R_{HPF}$  between Pin 27 and Pin 28. ( $10k\Omega \sim 47k\Omega$ )
3. In every electric field
  - (a) In case the detection sensitivity is excellent but the PNL effect deteriorated due to holding level fluctuation by noise, suitably increase the resistance value of the resistor connected in series with the Pin 5 holding capacitor. ( $1k\Omega \sim 3.3k\Omega$ )
  - (b) In case noise of the gate pulse itself is conspicuous, suitably narrow the gate pulse width by decreasing the resistance value of the Pin 4 resistor. ( $3k\Omega \sim 6.8k\Omega$ )



## ■ Supplementary Explanation (Continue)

### (2) Selection of AGC Resistor $R_{AGC}$ Pin 3

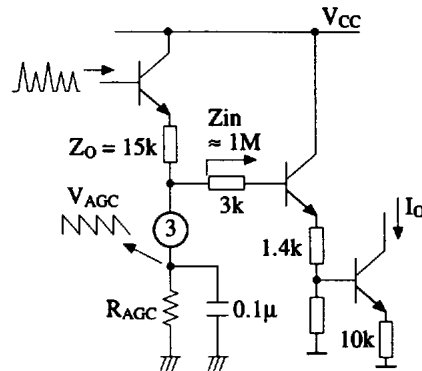

Fig. 2

Pin 3 is the AGC LPF, and enables AGC effective level adjustment. The equivalent circuit in the vicinity of this pin has been so constituted as shown in Fig. 2, and the output impedance at the charging time is  $15k\Omega$  while the input impedance at the discharging time is about  $1M\Omega$ .

The standard value of  $R_{AGC}$  is  $220\Omega$ , but in case operation error is frequently caused in weak electric field by white noise, selectively increase the value of  $R_{AGC}$  to a suitable level between  $200k\Omega$  and  $1M\Omega$ .

So long as the value of  $R_{AGC}$  was properly increased, the AGC voltage proportionally becomes higher to prolong the discharging time constant, and the rate of operation error sharply drops with decrease of the gain of the AGC Amp. (Through Pin 3, the noise components are put to peak (envelope) detection. Even if the value of  $R_{AGC}$  was increased, the charging time and voltage remain almost unchanged because  $Z_O = 15k\Omega$ .)

### (3) Selection of HPF Resistor $R_{HPF}$ Pin 27

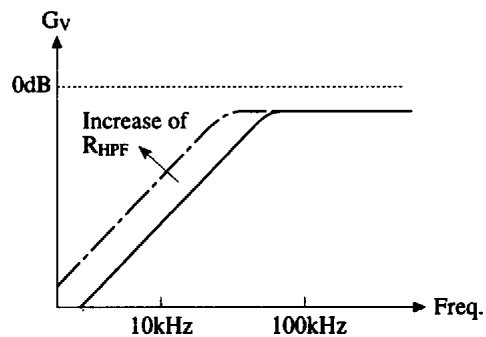

When the resistance value  $R_{HPF}$  of the resistor between Pin 27 and Pin 28 was increased, the cut-off frequency of the HPF proportionally becomes lower. The standard value of  $R_{HPF}$  is  $47k\Omega$ , but in case operation error is frequently caused in a weak electric field by white noise at the modulation time or non-modulation time, selectively increase this  $R_{HPF}$  to a suitable value not exceeding  $470k\Omega$ .