

RTF1090



RTF5010



RTF5020



RTF8080



AF



TQA

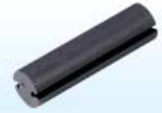

RTF1090

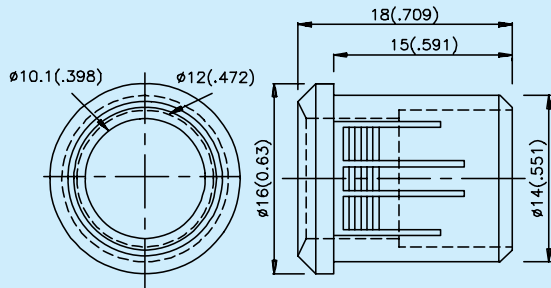

RTF5010

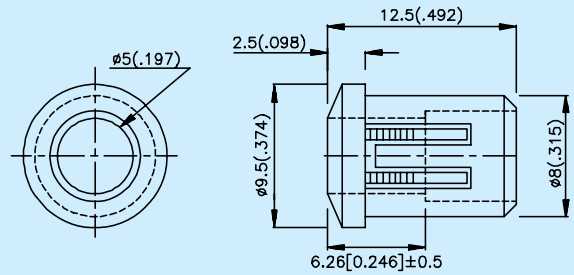

RTF8080

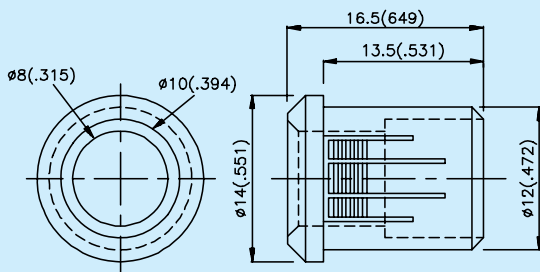

RTF5020

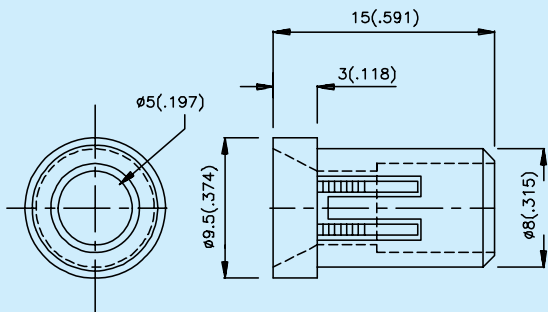

AF

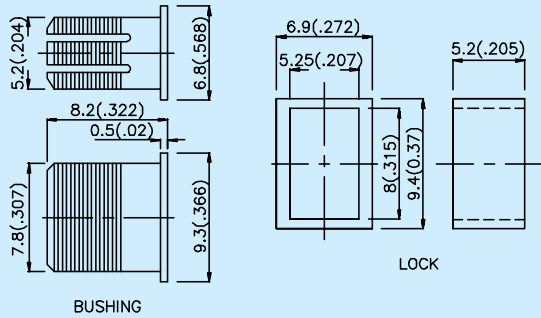

TQA

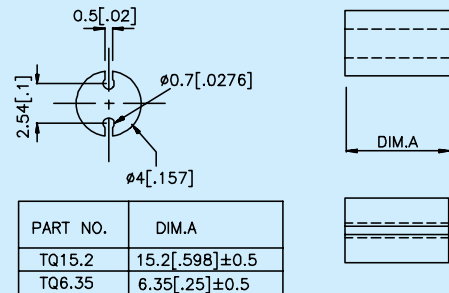

NOTES:

1. All dimensions are in millimeters(inches).
2. Tolerance is ±0.25mm(0.01") unless otherwise noted.