

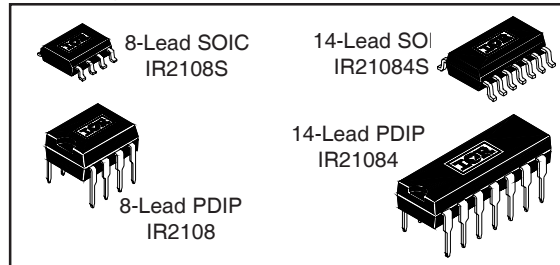
## IR2108(4) (S) & (PbF)

### HALF-BRIDGE DRIVER

#### Features

- Floating channel designed for bootstrap operation Fully operational to +600V Tolerant to negative transient voltage dV/dt immune
- Gate drive supply range from 10 to 20V
- Undervoltage lockout for both channels
- 3.3V, 5V and 15V input logic compatible
- Cross-conduction prevention logic
- Matched propagation delay for both channels
- High side output in phase with HIN input
- Low side output out of phase with LIN input
- Logic and power ground +/- 5V offset.
- Internal 540ns dead-time, and programmable up to 5us with one external R<sub>DT</sub> resistor (IR21084)
- Lower di/dt gate driver for better noise immunity
- Available in Lead-Free

#### Packages



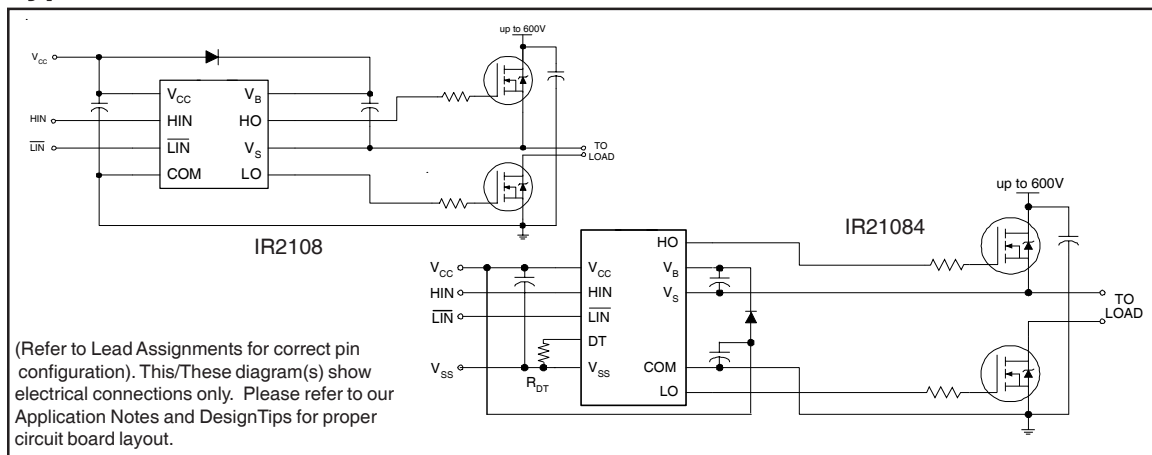
#### 2106/2301//2108//2109/2302/2304 Feature Comparison

Part	Input logic	Cross-conduction prevention logic	Dead-Time	Ground Pins
2106/2301	HIN/LIN	no	none	COM
21064				VSS/COM
2108	HIN/LIN	yes	Internal 540ns	COM
21084				VSS/COM
2109/2302	IN/SD	yes	Internal 540ns	COM
21094				VSS/COM
2304	HIN/LIN	yes	Internal 100ns	COM

#### Description

The IR2108(4)(S) are high voltage, high speed power MOSFET and IGBT drivers with dependent high and low side referenced output channels. Proprietary HVIC and latch immune CMOS technologies enable ruggedized monolithic construction. The logic input is compatible with standard CMOS or LSTTL output, down to 3.3V logic. The output drivers feature a high pulse current buffer stage designed for minimum driver cross-conduction. The floating channel can be used to drive an N-channel power MOSFET or IGBT in the high side configuration which operates up to 600 volts.

#### Typical Connection



# IR2108(4) (S) & (PbF)

## Absolute Maximum Ratings

Absolute maximum ratings indicate sustained limits beyond which damage to the device may occur. All voltage parameters are absolute voltages referenced to COM. The thermal resistance and power dissipation ratings are measured under board mounted and still air conditions.

Symbol	Definition	Min.	Max.	Units	
V <sub>B</sub>	High side floating absolute voltage	-0.3	625	V	
V <sub>S</sub>	High side floating supply offset voltage	V <sub>B</sub> - 25	V <sub>B</sub> + 0.3		
V <sub>HO</sub>	High side floating output voltage	V <sub>S</sub> - 0.3	V <sub>B</sub> + 0.3		
V <sub>CC</sub>	Low side and logic fixed supply voltage	-0.3	25		
V <sub>LO</sub>	Low side output voltage	-0.3	V <sub>CC</sub> + 0.3		
DT	Programmable dead-time pin voltage (IR21084 only)	V <sub>SS</sub> - 0.3	V <sub>CC</sub> + 0.3		
V <sub>IN</sub>	Logic input voltage (HIN & LIN)	V <sub>SS</sub> - 0.3	V <sub>CC</sub> + 0.3		
V <sub>SS</sub>	Logic ground (IR21084 only)	V <sub>CC</sub> - 25	V <sub>CC</sub> + 0.3		
dV <sub>S</sub> /dt	Allowable offset supply voltage transient	—	50	V/ns	
P <sub>D</sub>	Package power dissipation @ T <sub>A</sub> ≤ +25°C	(8 lead PDIP)	—	1.0	W
		(8 lead SOIC)	—	0.625	
		(14 lead PDIP)	—	1.6	
		(14 lead SOIC)	—	1.0	
R <sub>thJA</sub>	Thermal resistance, junction to ambient	(8 lead PDIP)	—	125	°C/W
		(8 lead SOIC)	—	200	
		(14 lead PDIP)	—	75	
		(14 lead SOIC)	—	120	
T <sub>J</sub>	Junction temperature	—	150	°C	
T <sub>S</sub>	Storage temperature	-50	150		
T <sub>L</sub>	Lead temperature (soldering, 10 seconds)	—	300		

## Recommended Operating Conditions

The Input/Output logic timing diagram is shown in figure 1. For proper operation the device should be used within the recommended conditions. The V<sub>S</sub> and V<sub>SS</sub> offset rating are tested with all supplies biased at 15V differential.

Symbol	Definition	Min.	Max.	Units	
V <sub>B</sub>	High side floating supply absolute voltage	V <sub>S</sub> + 10	V <sub>S</sub> + 20	V	
V <sub>S</sub>	High side floating supply offset voltage	Note 1	600		
V <sub>HO</sub>	High side floating output voltage	V <sub>S</sub>	V <sub>B</sub>		
V <sub>CC</sub>	Low side and logic fixed supply voltage	10	20		
V <sub>LO</sub>	Low side output voltage	0	V <sub>CC</sub>		
V <sub>IN</sub>	Logic input voltage	IR2108	COM		V <sub>CC</sub>
		IR21084	V <sub>SS</sub>		V <sub>CC</sub>
DT	Programmable dead-time pin voltage (IR21084 only)	V <sub>SS</sub>	V <sub>CC</sub>	°C	
V <sub>SS</sub>	Logic ground (IR21084 only)	-5	5		
T <sub>A</sub>	Ambient temperature	-40	125		

Note 1: Logic operational for V<sub>S</sub> of -5 to +600V. Logic state held for V<sub>S</sub> of -5V to -V<sub>BS</sub>. (Please refer to the Design Tip DT97-3 for more details).

**Dynamic Electrical Characteristics**

V<sub>BIAS</sub> (V<sub>CC</sub>, V<sub>BS</sub>) = 15V, V<sub>SS</sub> = COM, C<sub>L</sub> = 1000 pF, T<sub>A</sub> = 25°C, DT = V<sub>SS</sub> unless otherwise specified.

Symbol	Definition	Min.	Typ.	Max.	Units	Test Conditions
t <sub>on</sub>	Turn-on propagation delay	—	220	300	nsec	V <sub>S</sub> = 0V
t <sub>off</sub>	Turn-off propagation delay	—	200	280		V <sub>S</sub> = 0V or 600V
MT	Delay matching   t <sub>on</sub> - t <sub>off</sub>	—	0	30		
t <sub>r</sub>	Turn-on rise time	—	150	220		V <sub>S</sub> = 0V
t <sub>f</sub>	Turn-off fall time	—	50	80		V <sub>S</sub> = 0V
DT	Deadtime: LO turn-off to HO turn-on(DT <sub>LO-HO</sub> ) & HO turn-off to LO turn-on (DT <sub>HO-LO</sub> )	400	540	680		usec
		4	5	6	RDT = 200k (IR21084)	
MDT	Deadtime matching =   DT <sub>LO-HO</sub> - DT <sub>HO-LO</sub>	—	0	60	nsec	RDT=0
		—	0	600		RDT = 200k (IR21084)

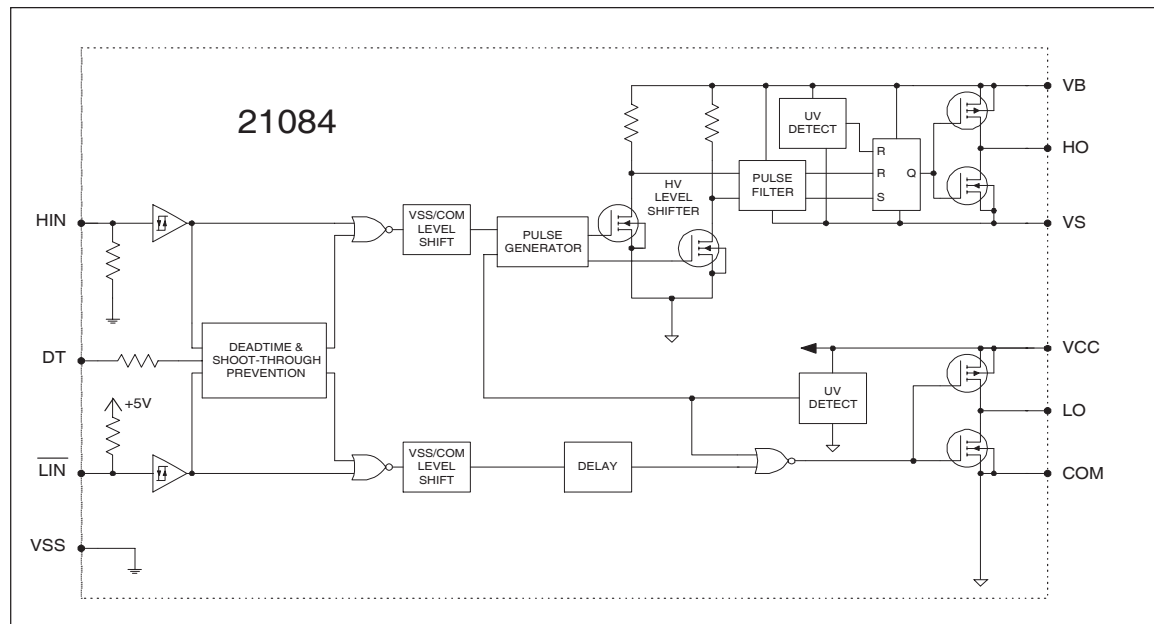
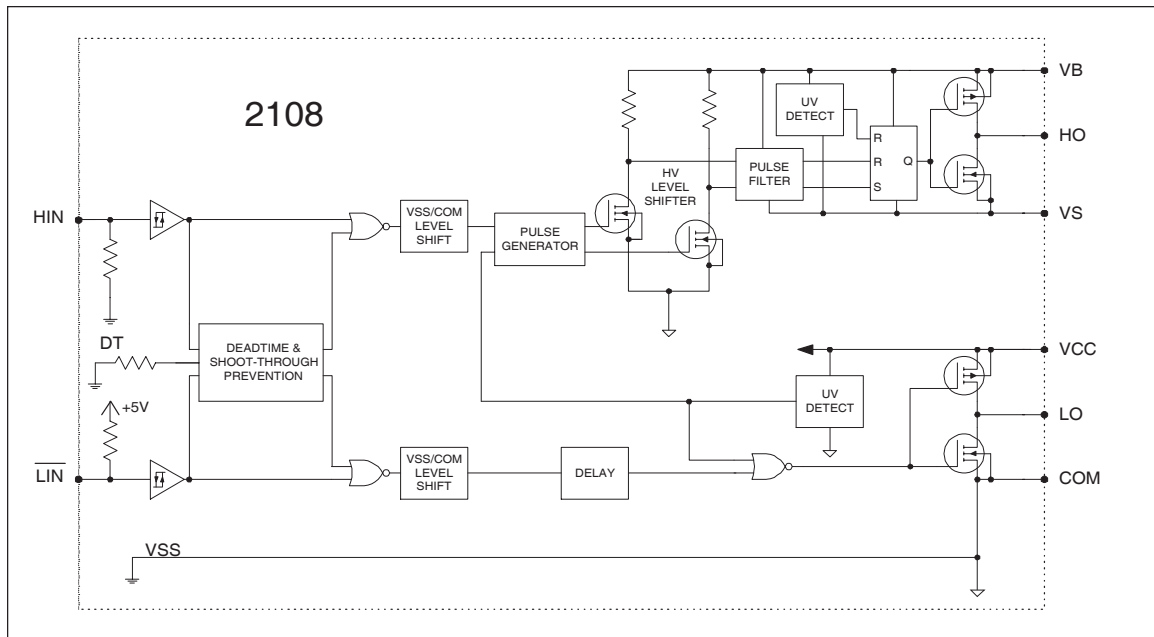
**Static Electrical Characteristics**

V<sub>BIAS</sub> (V<sub>CC</sub>, V<sub>BS</sub>) = 15V, V<sub>SS</sub> = COM, DT= V<sub>SS</sub> and T<sub>A</sub> = 25°C unless otherwise specified. The V<sub>IL</sub>, V<sub>IH</sub> and I<sub>IN</sub> parameters are referenced to V<sub>SS</sub>/COM and are applicable to the respective input leads: H<sub>IN</sub> and L<sub>IN</sub>. The V<sub>O</sub>, I<sub>O</sub> and R<sub>on</sub> parameters are referenced to COM and are applicable to the respective output leads: HO and LO.

Symbol	Definition	Min.	Typ.	Max.	Units	Test Conditions
V <sub>IH</sub>	Logic "1" input voltage for H <sub>IN</sub> & logic "0" for L <sub>IN</sub>	2.9	—	—	V	V <sub>CC</sub> = 10V to 20V
V <sub>IL</sub>	Logic "0" input voltage for H <sub>IN</sub> & logic "1" for L <sub>IN</sub>	—	—	0.8		V <sub>CC</sub> = 10V to 20V
V <sub>OH</sub>	High level output voltage, V <sub>BIAS</sub> - V <sub>O</sub>	—	0.8	1.4		I <sub>O</sub> = 20 mA
V <sub>OL</sub>	Low level output voltage, V <sub>O</sub>	—	0.3	0.6		I <sub>O</sub> = 20 mA
I <sub>LK</sub>	Offset supply leakage current	—	—	50	μA	V <sub>B</sub> = V <sub>S</sub> = 600V
I <sub>QBS</sub>	Quiescent V <sub>BS</sub> supply current	20	75	130	μA	V <sub>IN</sub> = 0V or 5V
I <sub>QCC</sub>	Quiescent V <sub>CC</sub> supply current	0.4	1.0	1.6	mA	V <sub>IN</sub> = 0V or 5V RDT=0
I <sub>IN+</sub>	Logic "1" input bias current	—	5	20	μA	H <sub>IN</sub> = 5V, L <sub>IN</sub> = 0V
I <sub>IN-</sub>	Logic "0" input bias current	—	—	2		H <sub>IN</sub> = 0V, L <sub>IN</sub> = 5V
V <sub>CCUV+</sub> V <sub>BSUV+</sub>	V <sub>CC</sub> and V <sub>BS</sub> supply undervoltage positive going threshold	8.0	8.9	9.8	V	
V <sub>CCUV-</sub> V <sub>BSUV-</sub>	V <sub>CC</sub> and V <sub>BS</sub> supply undervoltage negative going threshold	7.4	8.2	9.0		
V <sub>CCUVH</sub> V <sub>BSUVH</sub>	Hysteresis	0.3	0.7	—		
I <sub>O+</sub>	Output high short circuit pulsed current	120	200	—	mA	V <sub>O</sub> = 0V, PW ≤ 10 μs
I <sub>O-</sub>	Output low short circuit pulsed current	250	350	—		V <sub>O</sub> = 15V, PW ≤ 10 μs

# IR2108(4) (S) & (PbF)

## Functional Block Diagram



## Lead Definitions

Symbol	Description
HIN	Logic input for high side gate driver output (HO), in phase (referenced to COM for IR2108 and VSS for IR21084)
LIN	Logic input for low side gate driver output (LO), out of phase (referenced to COM for IR2108 and VSS for IR21084)
DT	Programmable dead-time lead, referenced to VSS. (IR21084 only)
VSS	Logic Ground (21084 only)
V <sub>B</sub>	High side floating supply
HO	High side gate driver output
V <sub>S</sub>	High side floating supply return
V <sub>CC</sub>	Low side and logic fixed supply
LO	Low side gate driver output
COM	Low side return

## Lead Assignments

<p>8 Lead PDIP</p>	<p>8 Lead SOIC</p>
<b>IR2108</b>	<b>IR2108S</b>
<p>14 Lead PDIP</p>	<p>14 Lead SOIC</p>
<b>IR21084</b>	<b>IR21084S</b>

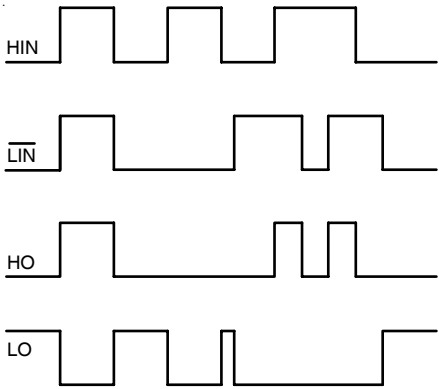


Figure 1. Input/Output Timing Diagram

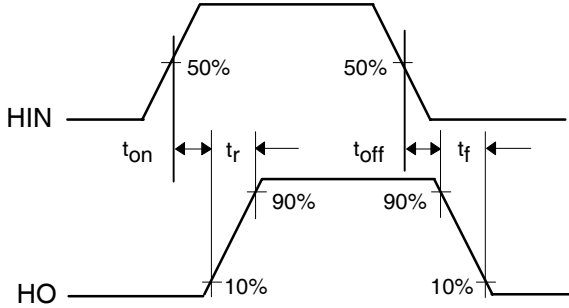
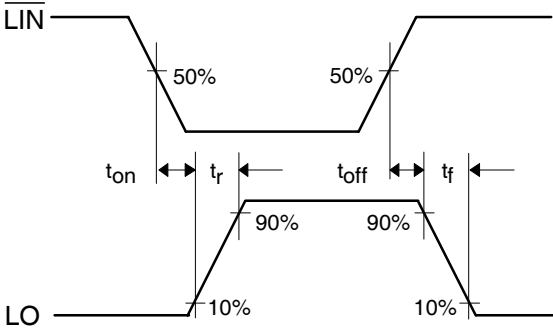


Figure 2. Switching Time Waveform Definitions

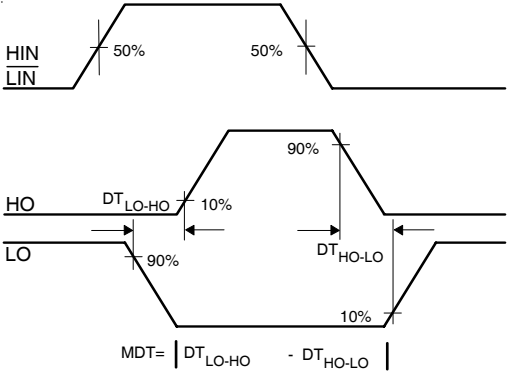
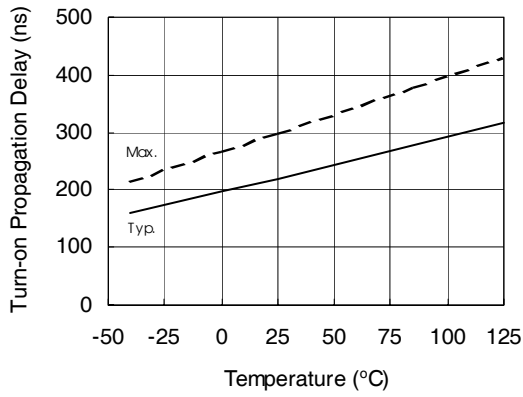
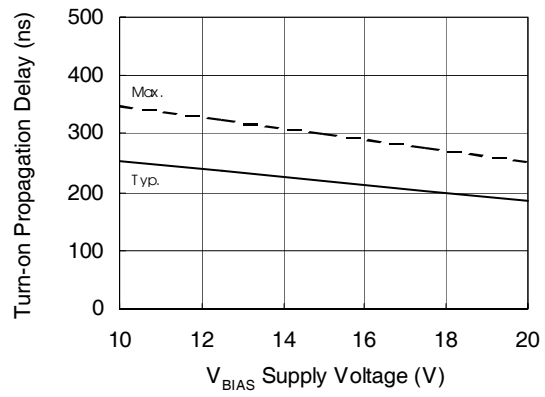


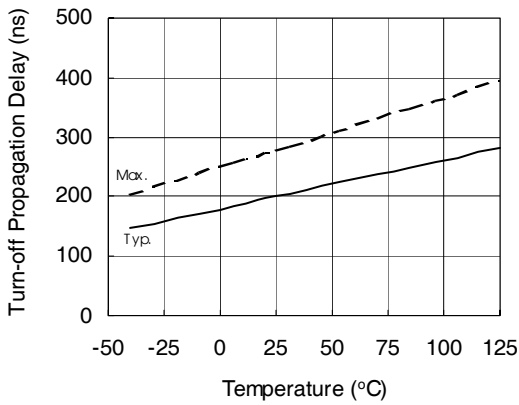
Figure 3. Deadtime Waveform Definitions



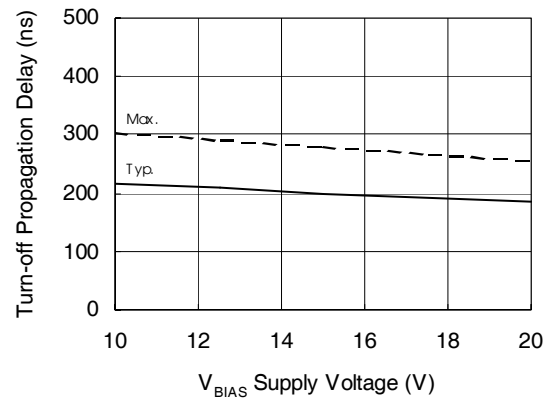
**Figure 4A. Turn-on Propagation Delay vs. Temperature**



**Figure 4B. Turn-on Propagation Delay vs. Supply Voltage**

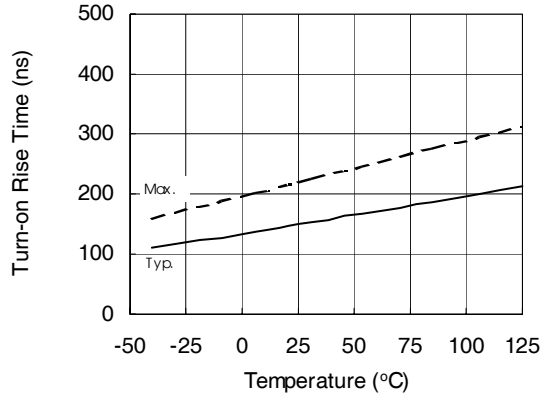


**Figure 5A. Turn-off Propagation Delay vs. Temperature**

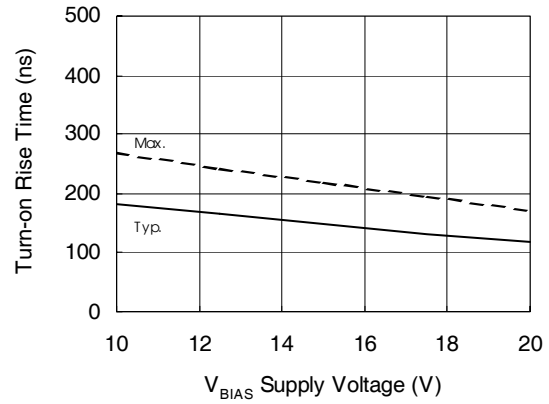


**Figure 5B. Turn-off Propagation Delay vs. Supply Voltage**

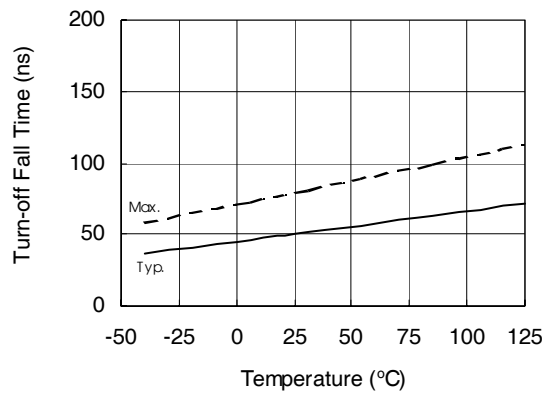
# IR2108(4) (S) & (PbF)



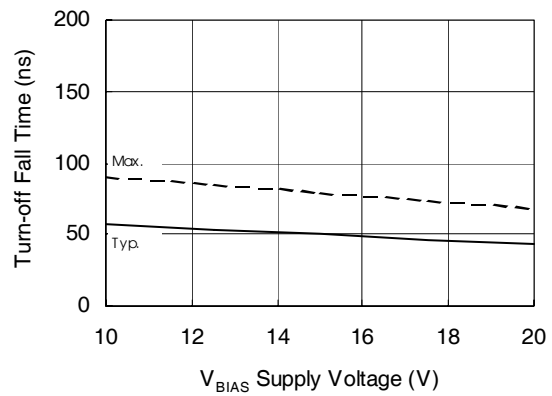
**Figure 6A. Turn-on Rise Time vs. Temperature**



**Figure 6B. Turn-on Rise Time vs. Supply Voltage**



**Figure 7A. Turn-off Fall Time vs. Temperature**



**Figure 7B. Turn-off Fall Time vs. Supply Voltage**



# IR2108(4) (S) & (PbF)

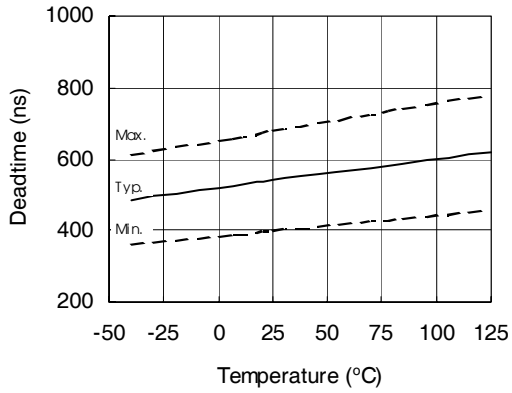


Figure 8A. Deadtime vs. Temperature

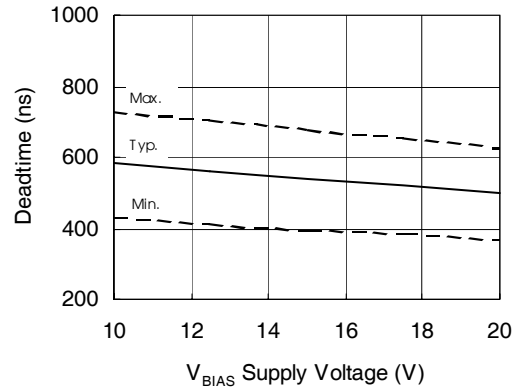


Figure 8B. Deadtime vs. Supply Voltage

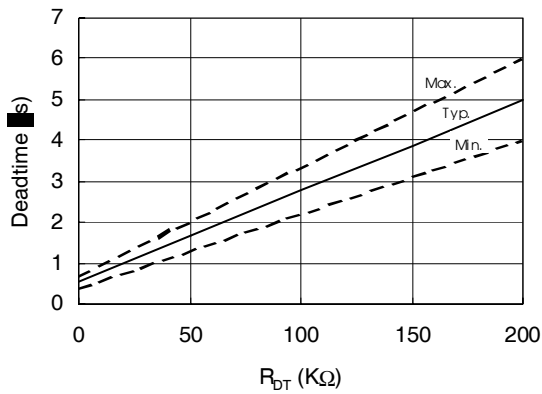


Figure 8C. Deadtime vs. R<sub>DT</sub>  
 (IR21084 Only)

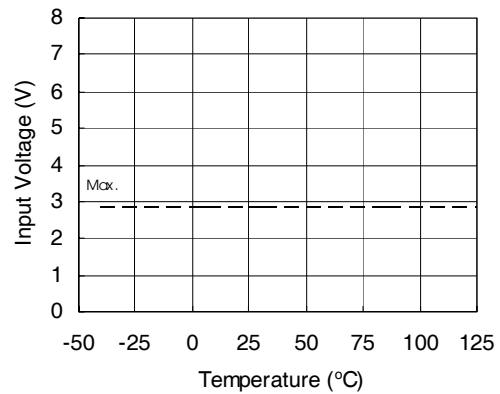
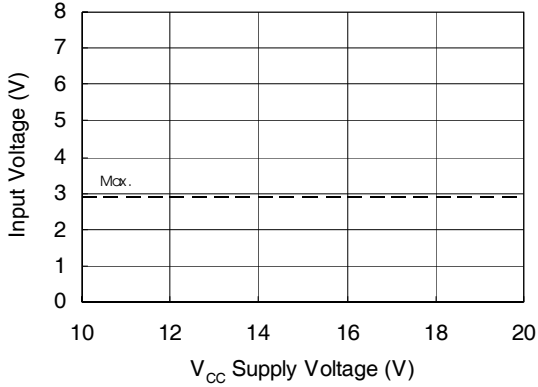
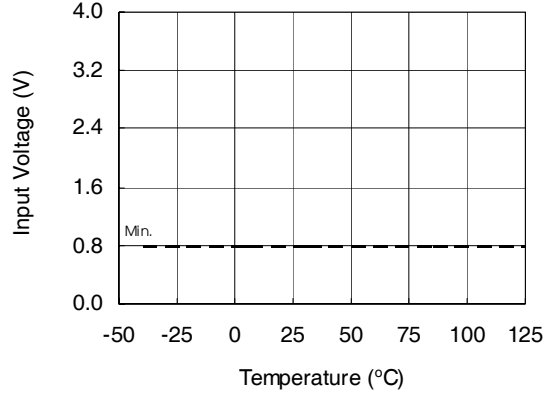


Figure 9A. Logic "1" Input Voltage  
 vs. Temperature

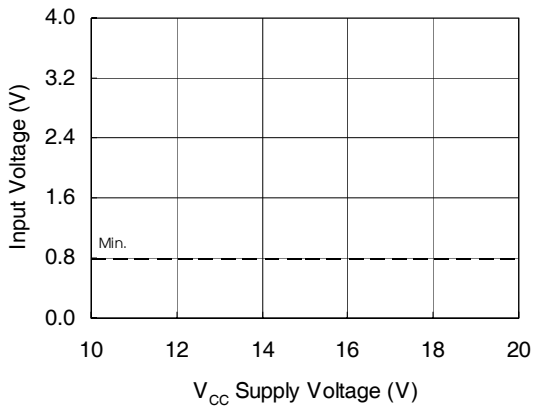
# IR2108(4) (S) & (PbF)



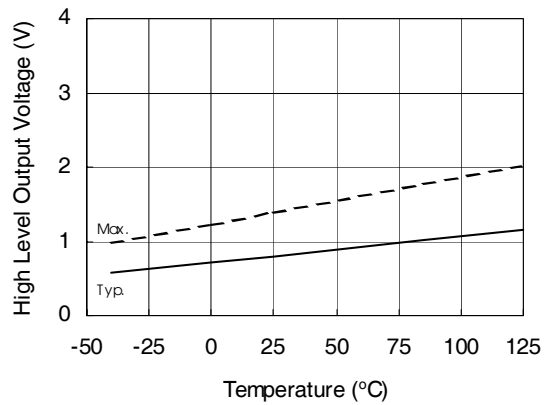
**Figure 9B. Logic "1" Input Voltage vs. Supply Voltage**



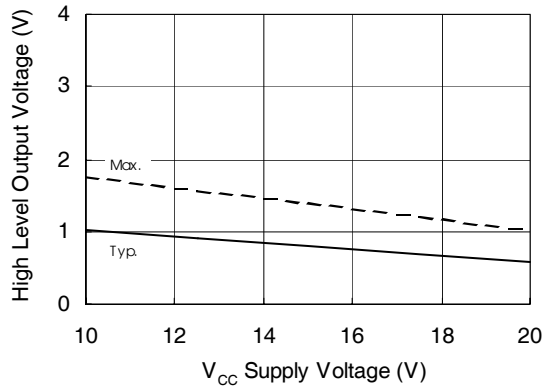
**Figure 10A. Logic "0" Input Voltage vs. Temperature**



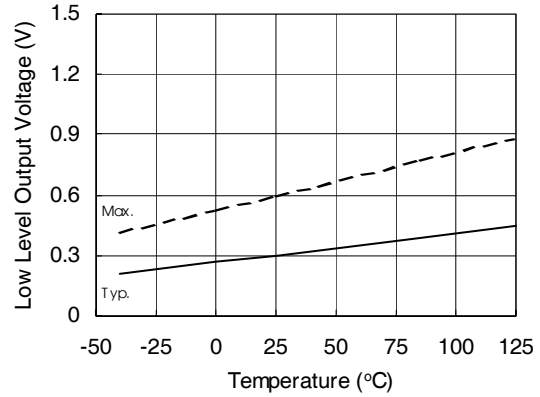
**Figure 10B. Logic "0" Input Voltage vs. Supply Voltage**



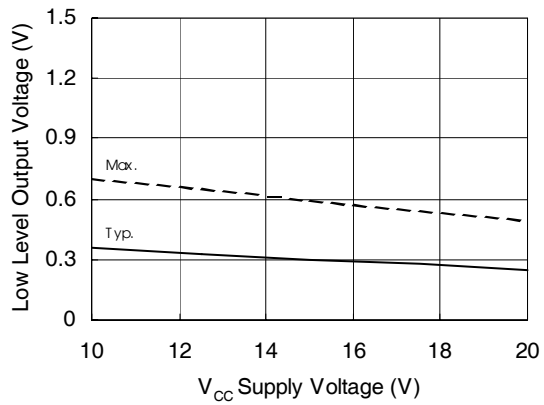
**Figure 11A. High Level Output vs. Temperature**



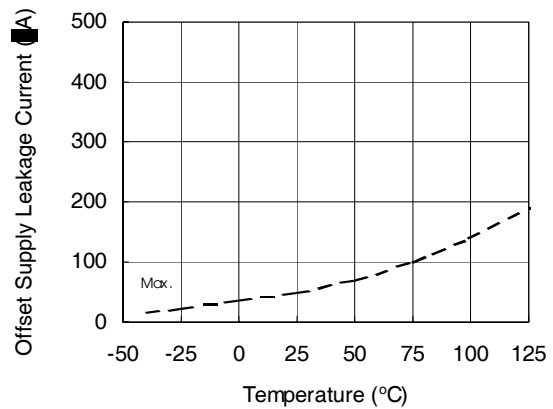
**Figure 11B. High Level Output vs. Supply Voltage**



**Figure 12A. Low Level Output vs. Temperature**



**Figure 12B. Low Level Output vs. Supply Voltage**



**Figure 13A. Offset Supply Leakage Current vs. Temperature**

# IR2108(4) (S) & (PbF)

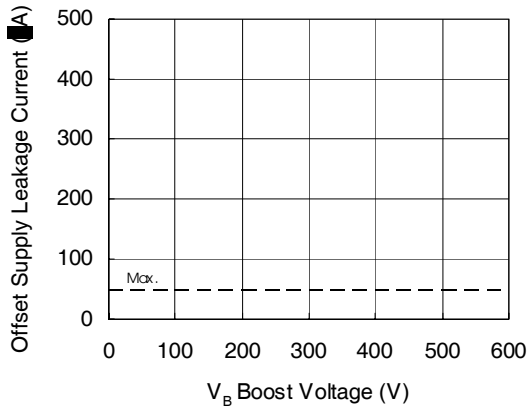


Figure 13B. Offset Supply Leakage Current vs. Temperature

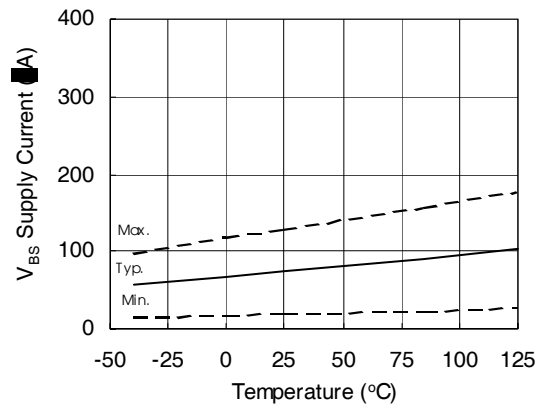


Figure 14A. V<sub>BS</sub> Supply Current vs. Temperature

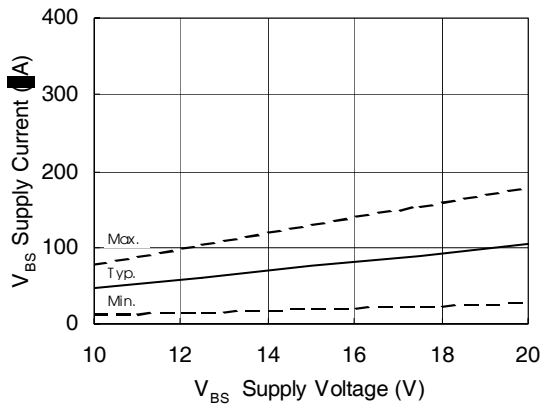


Figure 14B. V<sub>BS</sub> Supply Current vs. Supply Voltage

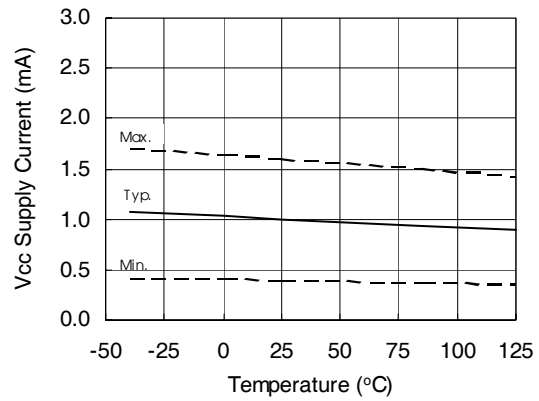
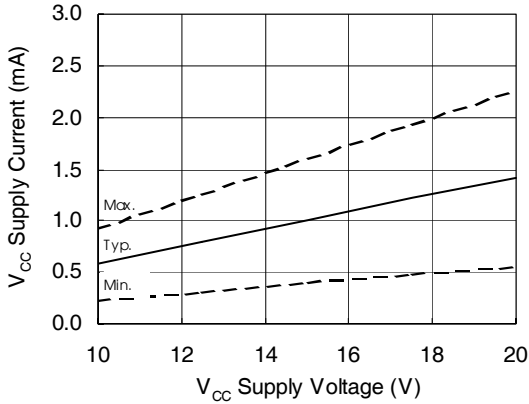
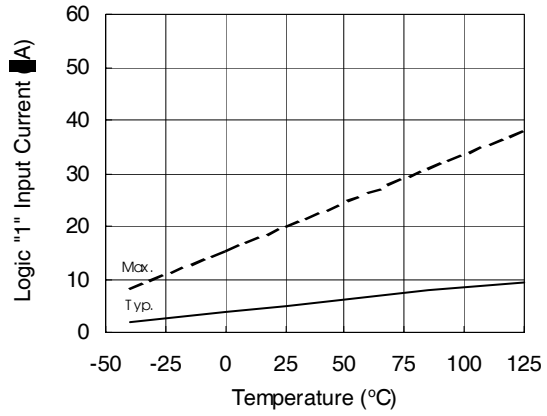


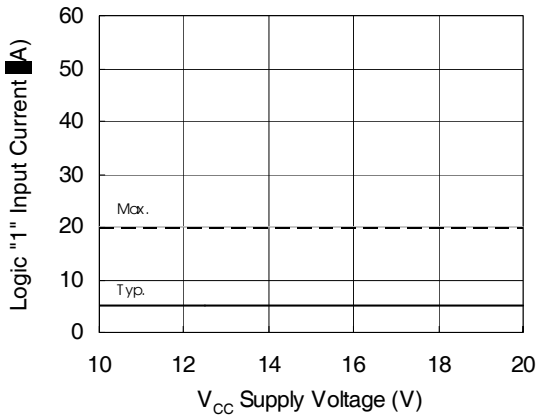
Figure 15A. V<sub>CC</sub> Supply Current vs. Temperature



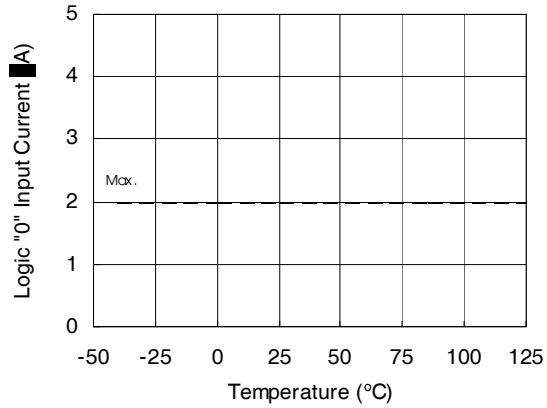
**Figure 15B. V<sub>CC</sub> Supply Current vs. Supply Voltage**



**Figure 16A. Logic "1" Input Current vs. Temperature**

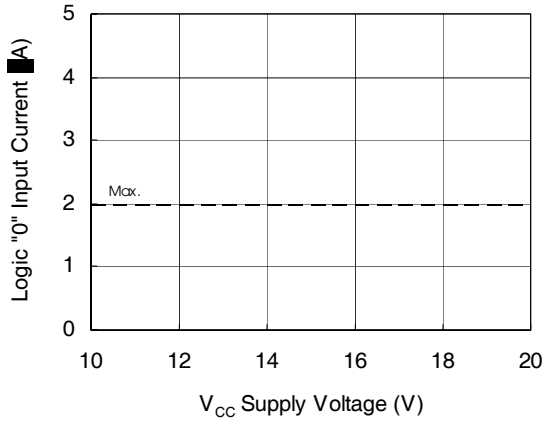


**Figure 16B. Logic "1" Input Current vs. Supply Voltage**

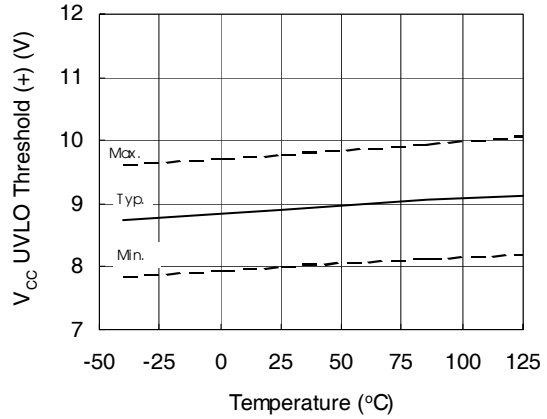


**Figure 17A. Logic "0" Input Current vs. Temperature**

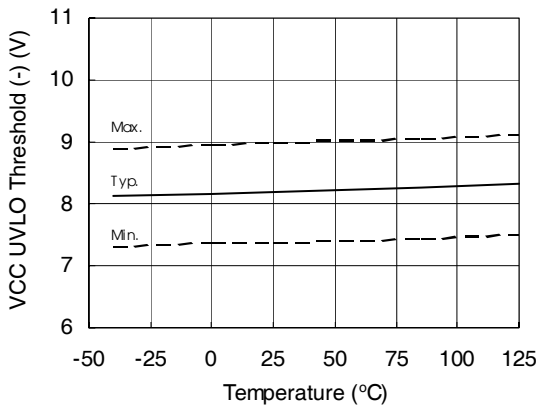
# IR2108(4) (S) & (PbF)



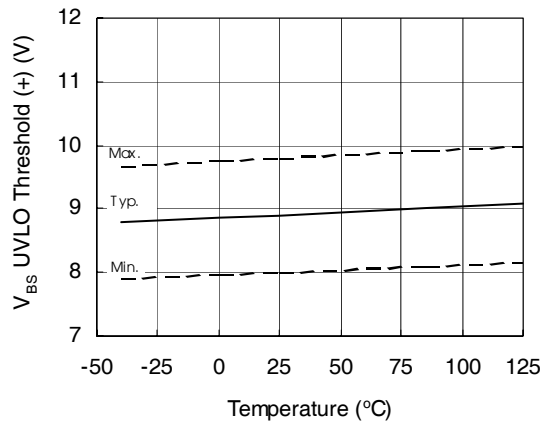
**Figure 17B. Logic "0" Input Current vs. Supply Voltage**



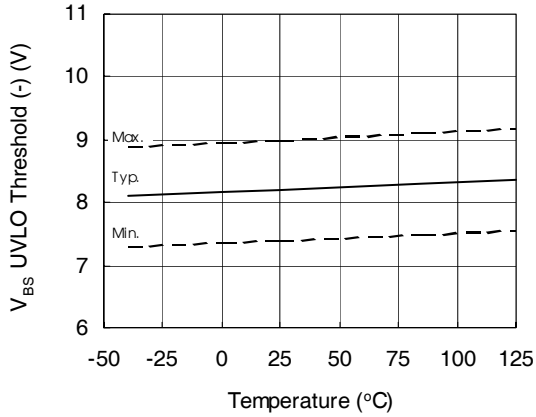
**Figure 18. V<sub>CC</sub> Undervoltage Threshold (+) vs. Temperature**



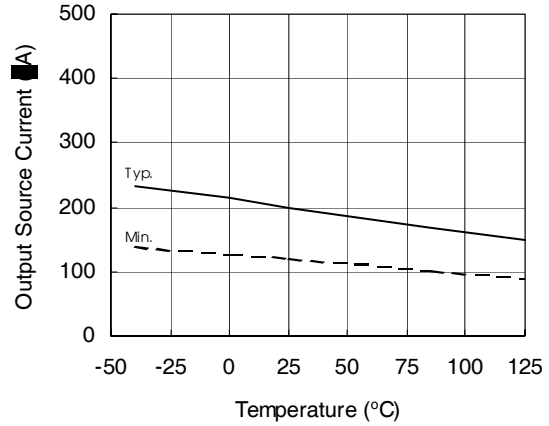
**Figure 19. V<sub>CC</sub> Undervoltage Threshold (-) vs. Temperature**



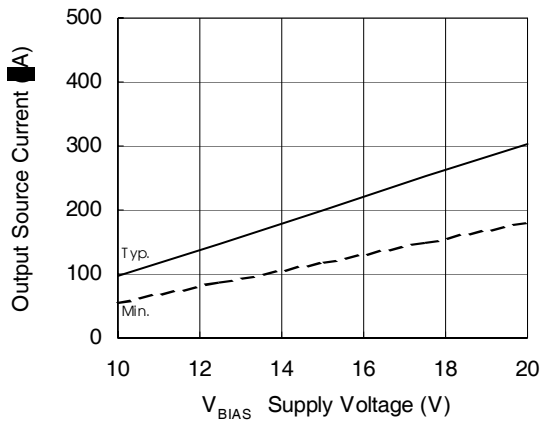
**Figure 20. V<sub>BS</sub> Undervoltage Threshold (+) vs. Temperature**



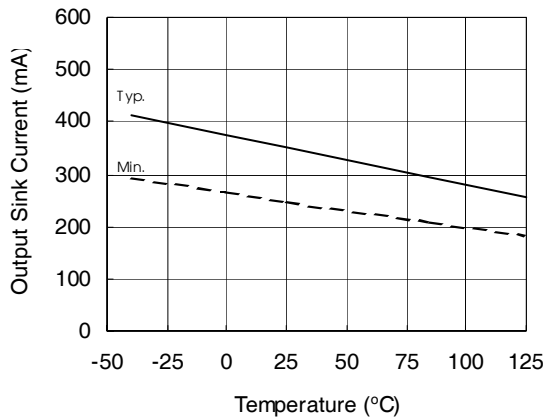
**Figure 21.  $V_{BS}$  Undervoltage Threshold (-) vs. Temperature**



**Figure 22A. Output Source Current vs. Temperature**

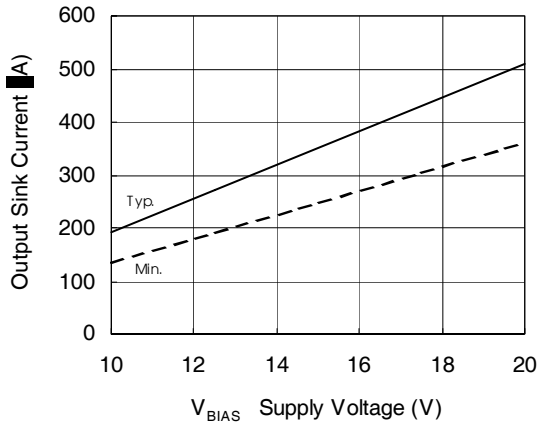


**Figure 22B. Output Source Current vs. Supply Voltage**

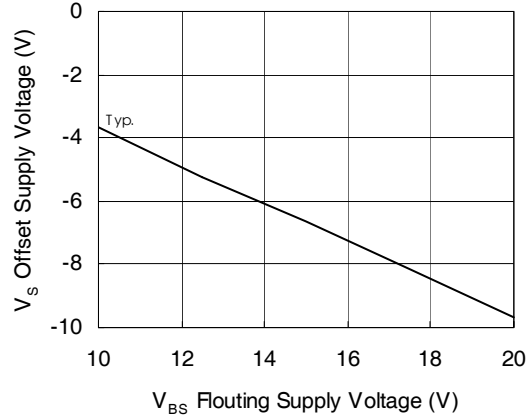


**Figure 23A. Output Sink Current vs. Temperature**

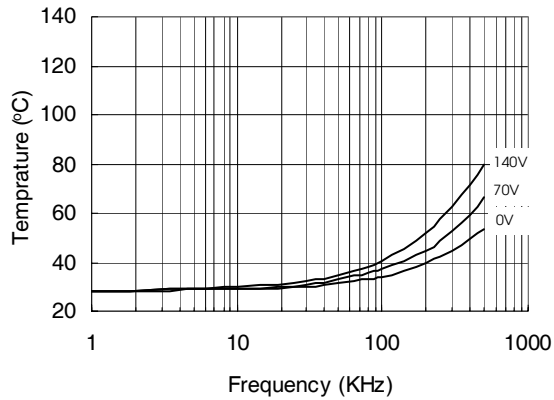
# IR2108(4) (S) & (PbF)



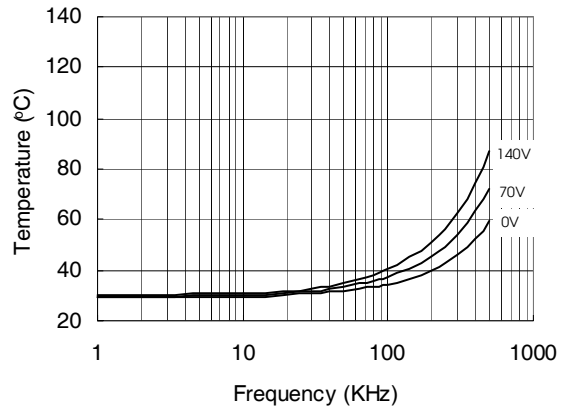
**Figure 23B. Output Sink Current vs. Supply Voltage**



**Figure 24. Maximum V<sub>s</sub> Negative Offset vs. Supply Voltage**



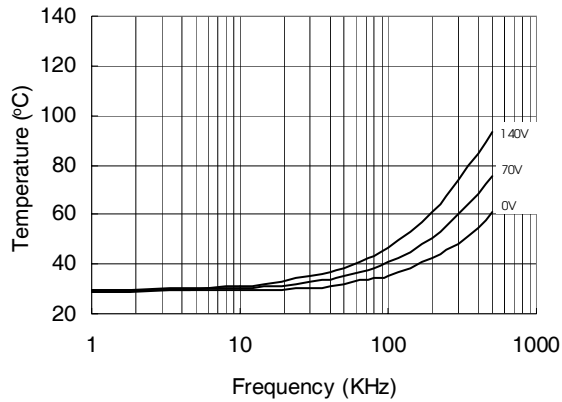
**Figure 25. IR2108 vs. Frequency (IRFBC20),  
R<sub>gate</sub>=33Ω, V<sub>CC</sub>=15V**



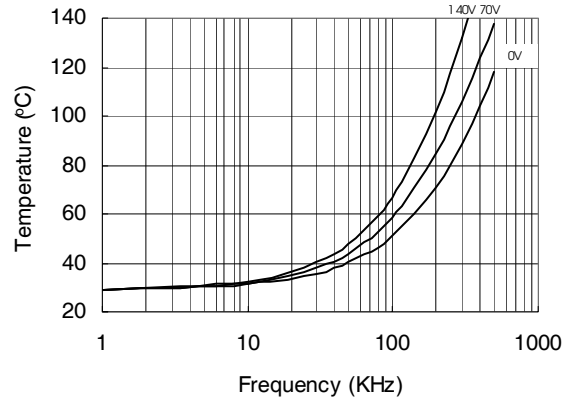
**Figure 26. IR2108 vs. Frequency (IRFBC30),  
R<sub>gate</sub>=22Ω, V<sub>CC</sub>=15V**



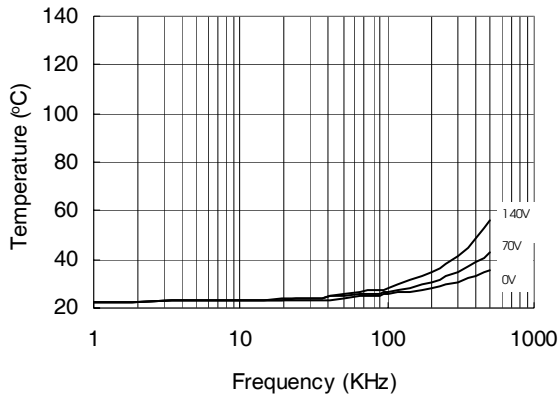
## IR2108(4) (S) & (PbF)



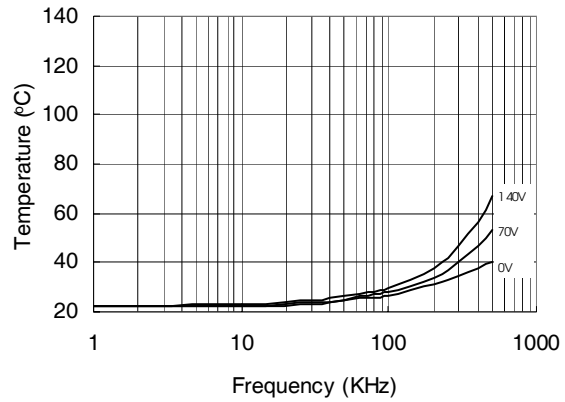
**Figure 27. IR2108 vs. Frequency (IRFBC40),  
 $R_{gate}=15\Omega$ ,  $V_{CC}=15V$**



**Figure 28. IR2108 vs. Frequency (IRFPE50),  
 $R_{gate}=10\Omega$ ,  $V_{CC}=15V$**



**Figure 29. IR21084 vs. Frequency (IRFBC20),  
 $R_{gate}=33\Omega$ ,  $V_{CC}=15V$**



**Figure 30. IR21084 vs. Frequency (IRFBC30),  
 $R_{gate}=22\Omega$ ,  $V_{CC}=15V$**

# IR2108(4) (S) & (PbF)

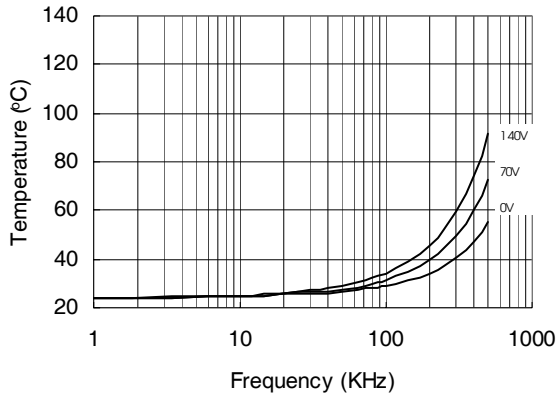


Figure 31. IR21084 vs. Frequency (IRFBC40),  
 $R_{gate}=15\Omega$ ,  $V_{CC}=15V$

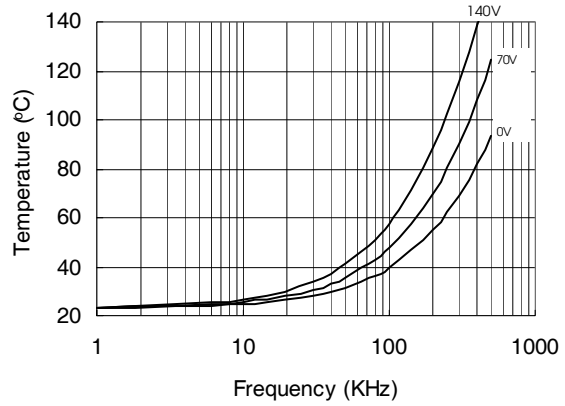


Figure 32. IR21084 vs. Frequency (IRFPE50),  
 $R_{gate}=10\Omega$ ,  $V_{CC}=15V$

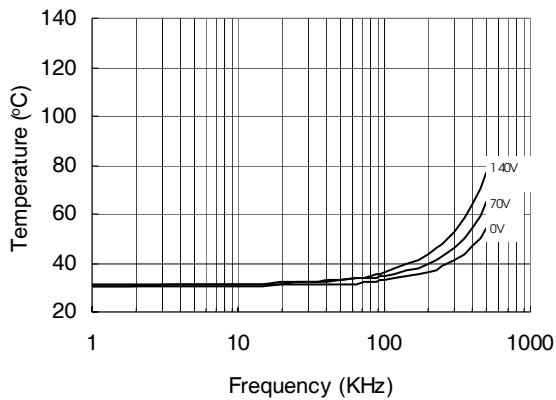


Figure 33. IR2108S vs. Frequency (IRFBC20),  
 $R_{gate}=33\Omega$ ,  $V_{CC}=15V$

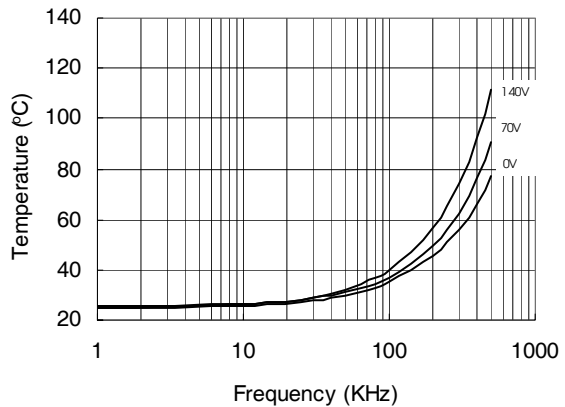
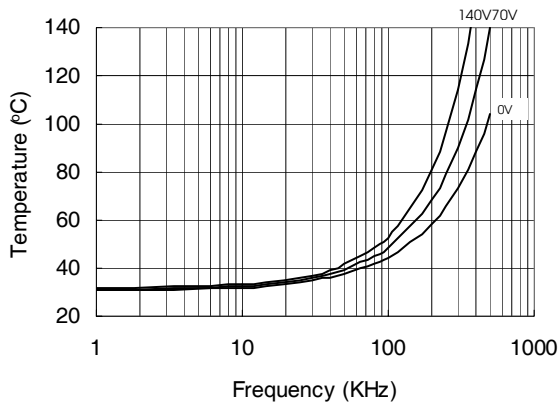
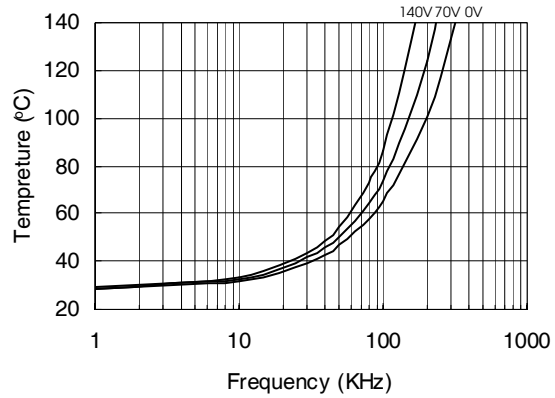


Figure 34. IR2108S vs. Frequency (IRFBC30),  
 $R_{gate}=22\Omega$ ,  $V_{CC}=15V$

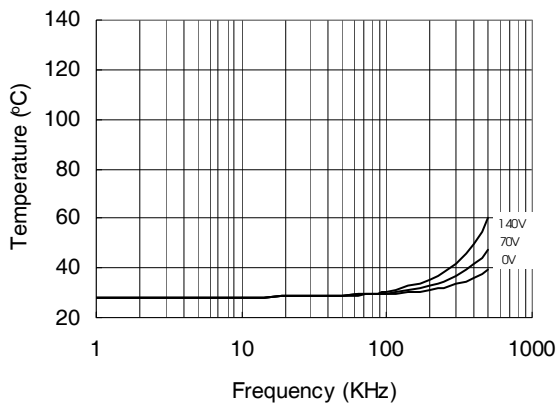
## IR2108(4) (S) & (PbF)



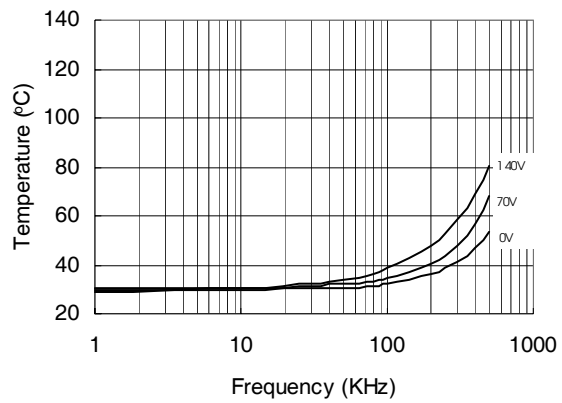
**Figure 35. IR2108S vs. Frequency (IRFBC40),  
 $R_{gate}=15\Omega, V_{CC}=15V$**



**Figure 36. IR2108S vs. Frequency  
(IRFPE50),  $R_{gate}=10\Omega, V_{CC}=15V$**

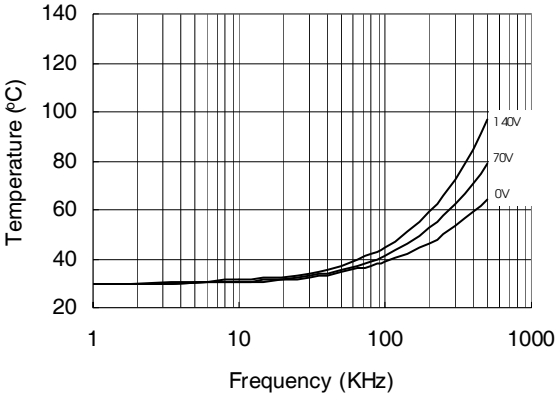


**Figure 37. IR21084S vs. Frequency (IRFBC20),  
 $R_{gate}=33\Omega, V_{CC}=15V$**

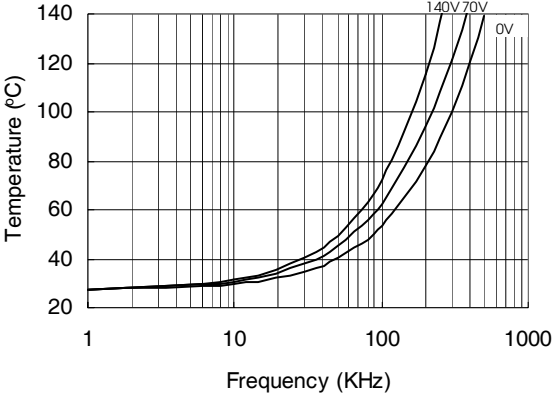


**Figure 38. IR21084S vs. Frequency (IRFBC30),  
 $R_{gate}=22\Omega, V_{CC}=15V$**

# IR2108(4) (S) & (PbF)

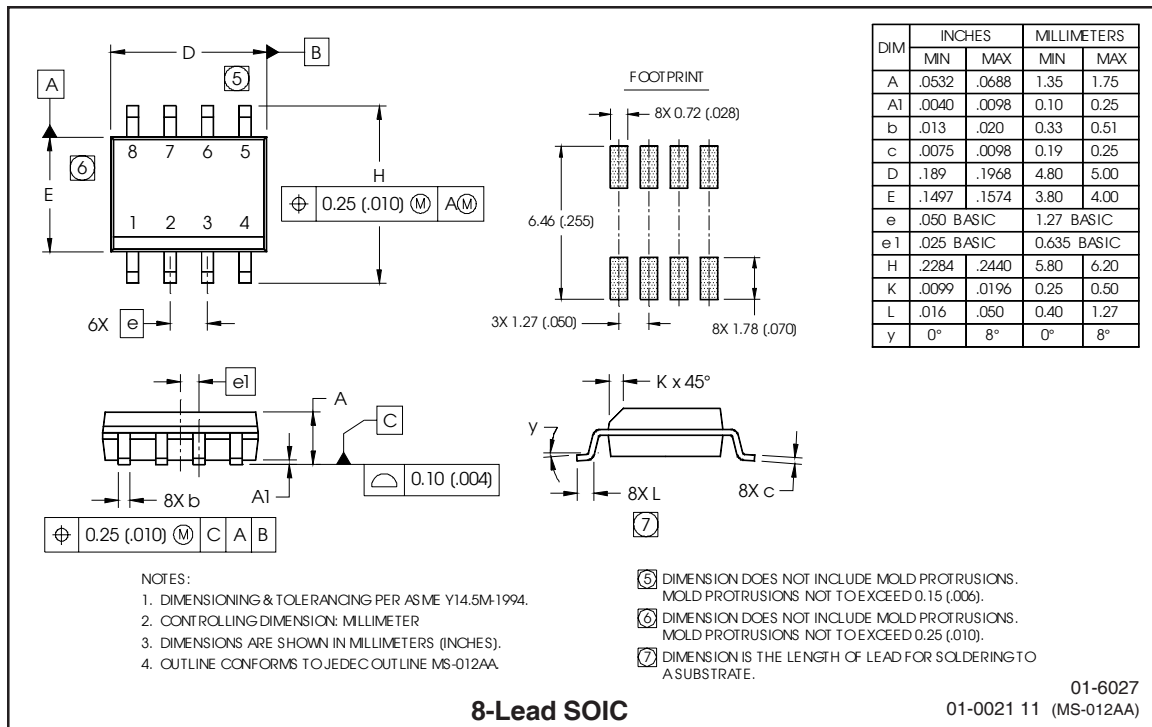
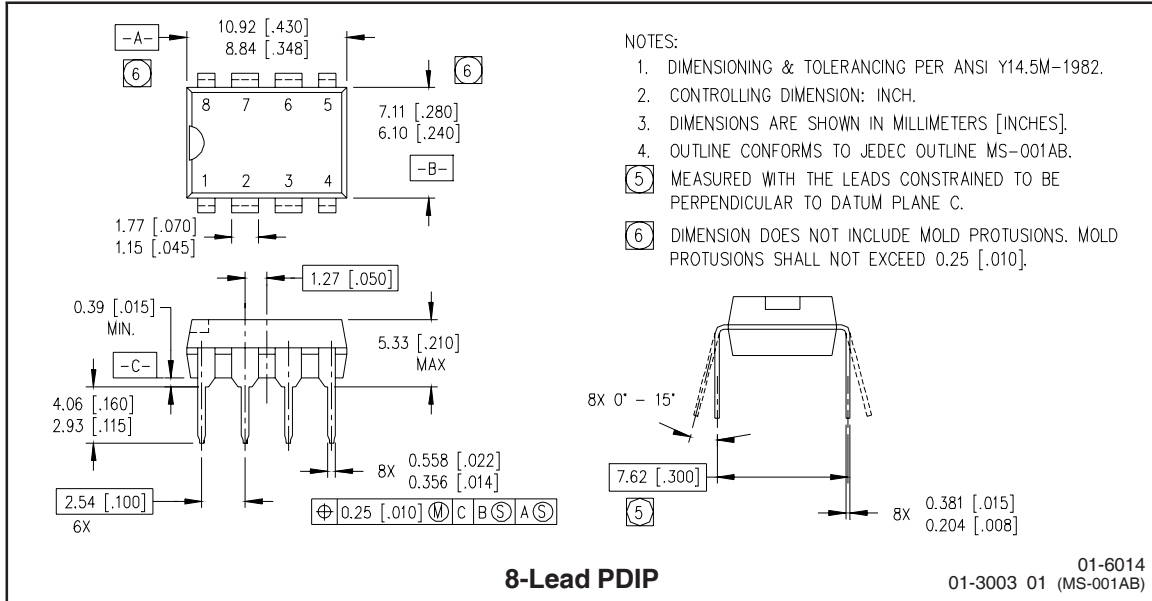


**Figure 39. IR21084S vs. Frequency (IRFBC40),**  
 $R_{gate}=15\Omega, V_{cc}=15V$



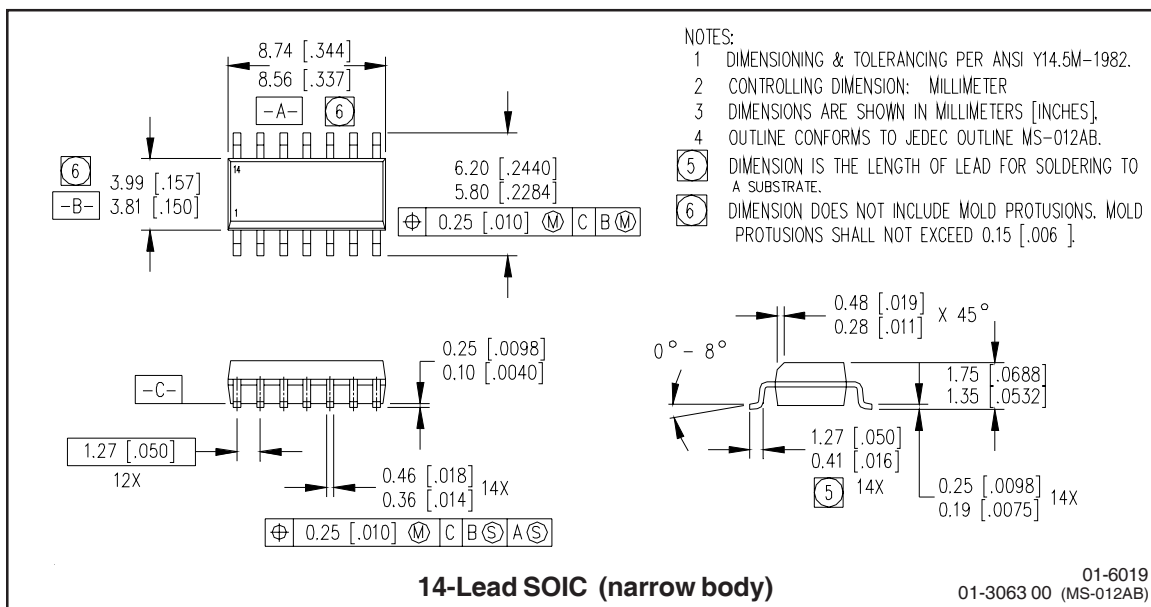
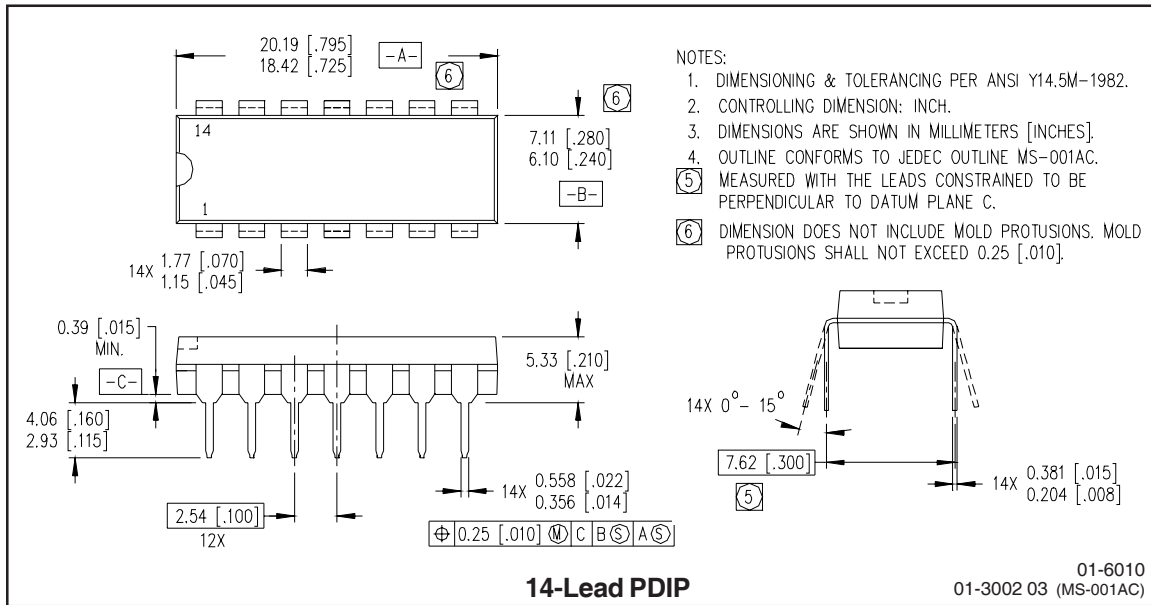
**Figure 40. IR21084S vs. Frequency (IRFPE50),**  
 $R_{gate}=10\Omega, V_{cc}=15V$

## Case outlines

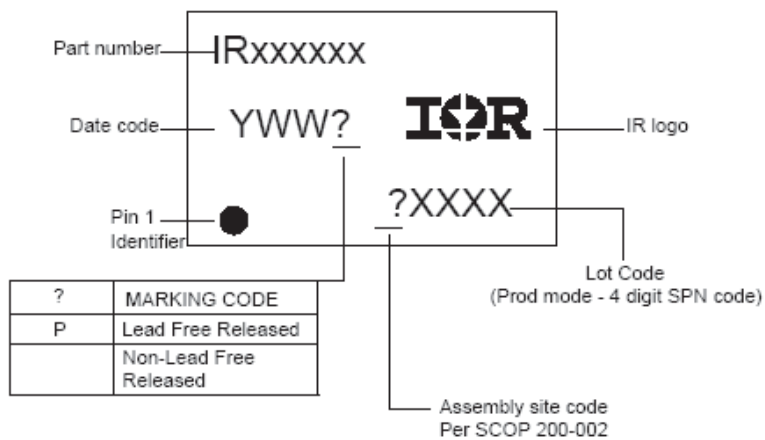


# IR2108(4) (S) & (PbF)

International  
IR Rectifier



**LEADFREE PART MARKING INFORMATION**



**ORDER INFORMATION**

**Basic Part (Non-Lead Free)**

8-Lead PDIP IR2108 order IR2108  
 8-Lead SOIC IR2108S order IR2108S  
 14-Lead PDIP IR21084 order IR21084  
 14-Lead SOIC IR21084S order IR21084S

**Lead-Free Part**

8-Lead PDIP IR2108 order IR2108PbF  
 8-Lead SOIC IR2108S order IR2108SPbF  
 14-Lead PDIP IR21084 order IR21084PbF  
 14-Lead SOIC IR21084S order IR21084SPbF