

SURFACE MOUNT SUPER FAST RECTIFIER

FEATURES

- Plastic package has underwrites laboratory Flammability Classification 94V-0
- Glass passivated chip junction
- Built-in strain relief,
- Super Fast switching speed for high efficiency
- High temperature soldering guaranteed: 260°C/ 10 seconds

MECHANICAL DATA

- Case: JEDED DO-214AB transfer molded plastic
- Terminals: Solder plated, solderable per MIL-STD-750 Method 2026
- Polarity: Color band denotes cathode end
- Weight: 0.007 ounce, 0.25 gram

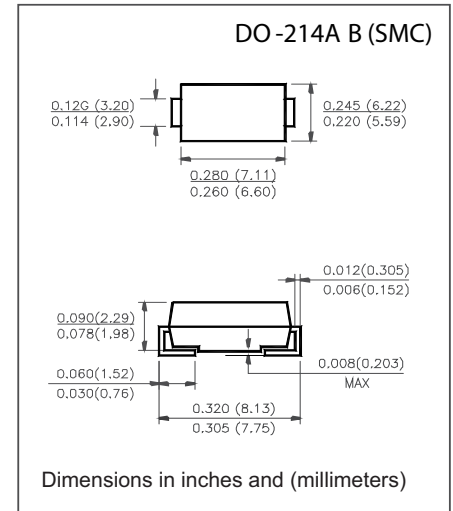

MAXIMUM RATINGS AND ELECTRICAL CHARACTERISTICS

- Ratings at 25 °C ambient temperature unless otherwise specified. Single phase, half wave, 60Hz, resistive or inductive load
For capacitive load derate current by 20%.

	SYMBOLS	ES3A	ES3B	ES3C	ES3D	ES3E	ES3G	ES3J	UNIT
Maximum Repetitive Peak Reverse Voltage	V_{RRM}	50	100	150	200	300	400	600	Volts
Maximum RMS Voltage	V_{RMS}	35	70	105	140	210	280	420	Volts
Maximum DC Blocking Voltage	V_{DC}	50	100	150	200	300	400	600	Volts
Maximum Average Forward Rectified Current at $T_L=100^\circ\text{C}$	$I_{(AV)}$	3.0							Amps
Peak Forward Surge Current 8.3ms single half sine-wave superimposed on rated load (JEDEC method)	I_{FSM}	100							Amps
Maximum Instantaneous Forward Voltage @ 3.0A	V_F	0.95					1.25	1.70	Volts
Maximum DC Reverse Current at rated DC Blocking Voltage per element	I_R	$T_A = 25^\circ\text{C}$							μA
		$T_A = 125^\circ\text{C}$							
Typical Reverse Recovery Time Test conditions $I_F=0.5\text{A}$, $I_R=1.0\text{A}$, $I_{RR}=0.25\text{A}$	t_{rr}	35							nS
Typical Junction Capacitance (Measured at 1.0MHz and applied reverse voltage of 4.0V)	C_J	45				30			pF
Typical Thermal Resistance (Note 1)	$R_{\theta JA}$	55							$^\circ\text{C}/\text{W}$
	$R_{\theta JL}$	17							
Operating Junction Temperature Range	T_J	(-55 to +150)							$^\circ\text{C}$
Storage Temperature Range	T_{STG}	(-55 to +150)							$^\circ\text{C}$

Notes:

1. Thermal resistance from Junction to ambient and from junction to lead mounted on P.C.B. with 0.3"×0.3"(8.0mm × 8.0mm) copper pad areas.

SURFACE MOUNT SUPER FAST RECTIFIER

RATING AND CHARACTERISTIC CURVES ES3A - ES3J

FIG.1-TYPICAL FORWARD CURRENT DERATING CURVE

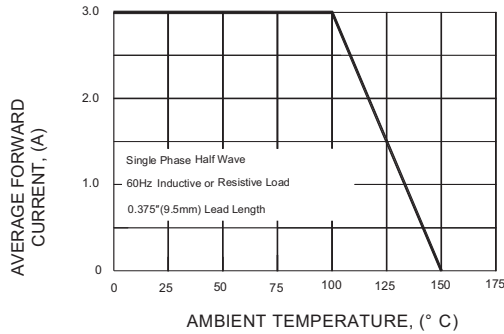

FIG.2-MAXIMUM NON-REPETITIVE PEAK FORWARD SURGE CURRENT

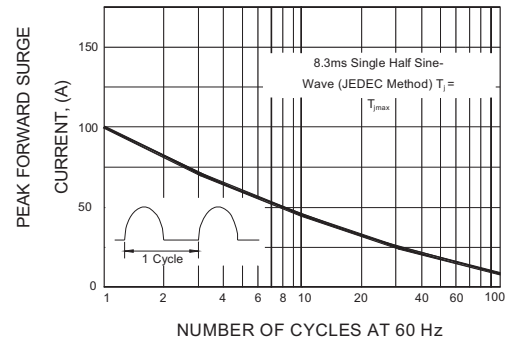

FIG.3-TYPICAL INSTANTANEOUS FORWARD CHARACTERISTICS

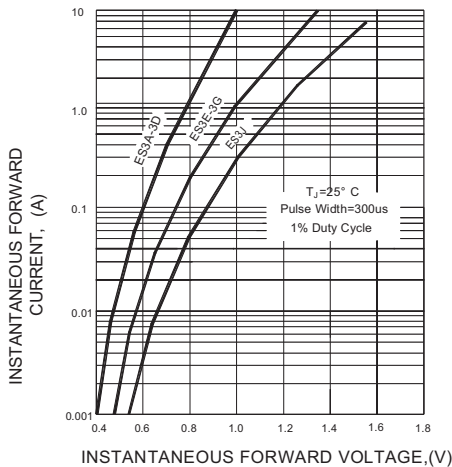

FIG.4-TYPICAL REVERSE CHARACTERISTICS

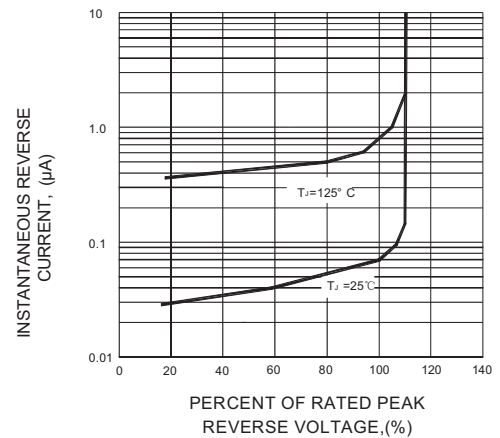

FIG.5-TYPICAL JUNCTION CAPACITANCE

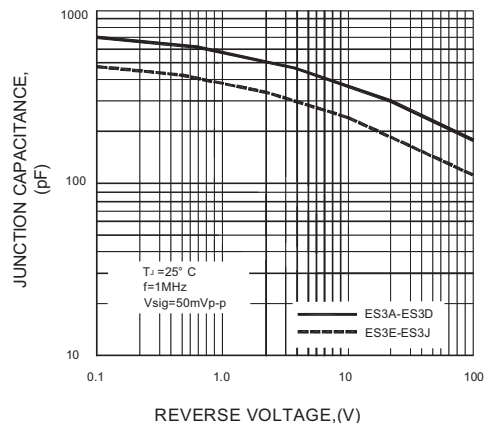
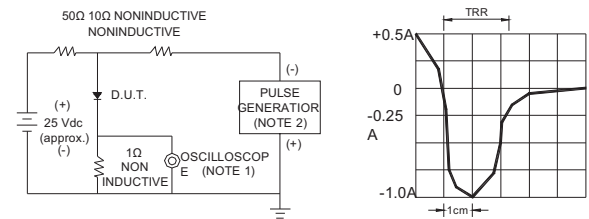

FIG.6-TEST CIRCUIT DIAGRAM AND REVERSE RECOVERY TIME CHARACTERISTIC



- NOTES : 1. Rise Time = 7ns max. Input Impedance = 1 megohm. 22pF
 2. Rise time = 10ns max. Source Impedance = 50 ohms

Disclaimer

All product, product specifications and data are subject to change without notice to improve reliability, function or design or otherwise.