

ROHM's Selection Operational Amplifier / Comparator Series



Operational Amplifiers: Ground Sense

**BA10358F/FV, BA10324AF/FV, BA2904SF/FV/FVM, BA2904F/FV/FVM,
BA2904HFVM-C, BA2902S F/FV/KN, BA2902F/FV/KN, BA3404F/FVM**

No.09049EAT03

●Description

General-purpose BA10358/BA10324A family and high-reliability BA2904S/BA2904/BA2902S/BA2902 family and automotive BA2904HFVM-C integrate two or four independent Op-Amps and phase compensation capacitors on a single chip and have some features of high-gain, low power consumption, and operating voltage range of 3[V] to 32[V] (single power supply). BA3404 family is realized high speed operation and reduce the crossover distortions that compare with BA10358/BA2904 family.

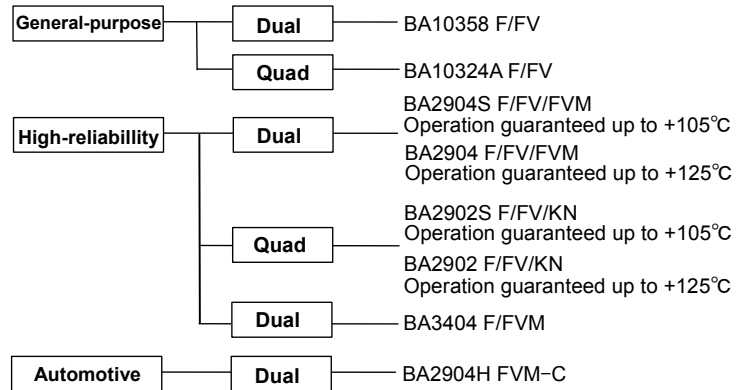

●Characteristics

- 1) Operable with a single power supply
- 2) Wide operating supply voltage
+3.0[V]~+32.0[V](single supply) (BA10358/BA10324A/BA2904S/BA2904/BA2902S/BA2902 family, BA2904HFVM-C)
+4.0[V]~+36.0[V](single supply) (BA3404 family)
- 3) Standard Op-Amp Pin-assignments
- 4) Input and output are operable GND sense
- 5) Internal phase compensation type
- 6) Low supply current
- 7) High open loop voltage gain
- 8) Internal ESD protection
Human body model(HBM) ±5000[V](Typ.) (BA2904S/BA2904/BA2902S/BA2902/BA3404 family, BA2904HFVM-C)
- 9) Gold PAD (BA2904S/BA2904/BA2902S/BA2902/BA3404 family, BA2904HFVM-C)
- 10) Wide temperature range
-40[°C]~+125[°C] (BA2904/BA2902 family, BA2904HFVM-C)
-40[°C]~+105[°C] (BA2904S/BA2902S family)
-40[°C]~+85[°C] (BA10358/BA10324/BA3404 family)

●Pin Assignment

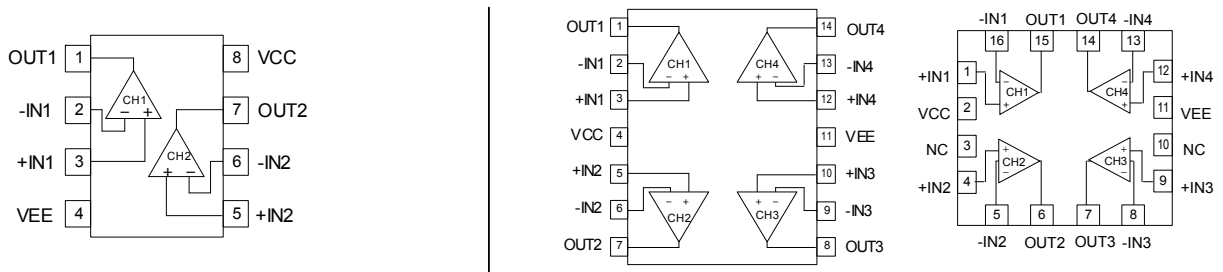

SOP8	SSOP-B8	MSOP8	SOP14	SSOP-B14	VQFN16
BA10358F BA2904SF BA2904F BA3404F	BA10358FV BA2904SFV BA2904FV	BA2904SFVM BA2904FVM BA3404FVM BA2904HFVM-C	BA10324AF BA2902SF BA2902F	BA10324AFV BA2902SFV BA2902FV	BA2902SKN BA2902KN

● Absolute Maximum Ratings (Ta=25[°C])
OBA10358 family,BA10324A family

Parameter	Symbol	Rating		Unit
		BA10358 family	BA10324A family	
Supply Voltage	VCC-VEE	+32		V
Differential Input Voltage ^(*1)	Vid	VCC-VEE		V
Input Common-mode Voltage Range	Vicm	VEE~VCC		V
Operating Temperature Range	Topr	-40~+85		°C
Storage Temperature Range	Tstg	-55~+125		°C
Maximum Junction Temperature	Tjmax	+125		°C

Note Absolute maximum rating item indicates the condition which must not be exceeded.

Application if voltage in excess of absolute maximum rating or use out of absolute maximum rated temperature environment may cause deterioration of characteristics.

(*1) The voltage difference between inverting input and non-inverting input is the differential input voltage.
Then input terminal voltage is set to more than VEE.

● Electric Characteristics

OBA10358 family,BA10324A family(Unless otherwise specified VCC=+5[V], VEE=0[V], Ta=25[°C])

Parameter	Symbol	Temperature Range	Guaranteed limit						Unit	Condition
			BA10358 family			BA10324A family				
			Min.	Typ.	Max.	Min.	Typ.	Max.		
Input Offset Voltage	Vio	25°C	-	2	7	-	2	7	mV	RS=50[Ω]
Input Offset Current	Iio	25°C	-	5	50	-	5	50	nA	-
Input Bias Current (*2)	Ib	25°C	-	45	250	-	20	250	nA	-
Supply Current	ICC	25°C	-	0.7	1.2	-	0.6	2	mA	RL=∞, All Op-Amps
High Level Output Voltage	VOH	25°C	-	-	-	VCC-1.5	-	-	V	RL=2[kΩ]
Low Level Output Voltage	VOL	25°C	-	-	-	-	-	250	mV	RL=2[kΩ]
Large Signal Voltage Gain	AV	25°C	25	100	-	25	100	-	V/mV	RL ≥ 2[kΩ], VCC=15[V]
Input Common-mode Voltage Range	Vicm	25°C	0	-	VCC-1.5	0	-	VCC-1.5	V	-
Common-mode Rejection Ratio	CMRR	25°C	65	80	-	65	75	-	dB	-
Power Supply Rejection Ratio	PSRR	25°C	65	100	-	65	100	-	dB	RS=50[Ω]
Output Source Current	IOH	25°C	10	20	-	20	35	-	mA	VIN+=1[V], VIN-=0[V], VOUT=0[V]
Output Sink Current	IOL	25°C	10	20	-	10	20	-	mA	VIN+=0[V], VIN-=1[V], VOUT=VCC
Output Voltage Range	Vo	25°C	0	-	VCC-1.5	-	-	-	V	RL=2[kΩ]
Channel Separation	CS	25°C	-	120	-	-	120	-	dB	f=1[kHz], input referred

(*2) Current direction: Since first input stage is composed with PNP transistor, input bias current flows out of IC.

● Absolute Maximum Ratings (Ta=25[°C])

OBA2904S/BA2904/BA2902S/BA2902 family,BA2904HFVM-C

Parameter	Symbol	Rating			Unit
		BA2904S family BA2902S family	BA2904 family BA2902 family	BA2904HFVM-C	
Supply Voltage	VCC-VEE	+32		+36	V
Differential Input Voltage (*3)	Vid	32		36	V
Input Common-mode Voltage Range	Vicm	(VEE-0.3)~(VEE+32)		(VEE-0.3)~(VEE+36)	V
Operating Temperature Range	Topr	-40~+105	-40~+125		°C
Storage Temperature Range	Tstg	-55~+150			°C
Maximum Junction Temperature	Tjmax	+150			°C

Note Absolute maximum rating item indicates the condition which must not be exceeded.

Application if voltage in excess of absolute maximum rating or use out of absolute maximum rated temperature environment may cause deterioration of characteristics.

(*3) The voltage difference between inverting input and non-inverting input is the differential input voltage. Then input terminal voltage is set to more than VEE.

● Electric Characteristics

OBA2904S/BA2904 family (Unless otherwise specified VCC=+5[V], VEE=0[V])

Parameter	Symbol	Temperature Range	Guaranteed limit			Unit	Condition
			BA2904S/BA2904 family				
			Min.	Typ.	Max.		
Input Offset Voltage (*4)	Vio	25°C	-	2	7	mV	VOUT=1.4[V]
		Full range	-	-	10		VCC=5~30[V],VOUT=1.4[V]
Input Offset Voltage Drift	$\Delta Vio/\Delta T$		-	± 7	-	$\mu V/^\circ C$	VOUT=1.4[V]
Input Offset Current (*4)	Iio	25°C	-	2	50	nA	VOUT=1.4[V]
		Full range	-	-	200		
Input Offset Current Drift	$\Delta Iio/\Delta T$		-	± 10	-	$pA/^\circ C$	VOUT=1.4[V]
Input Bias Current (*4)	Ib	25°C	-	20	250	nA	VOUT=1.4[V]
		Full range	-	-	250		
Supply Current	Vicm	25°C	-	0.7	1.2	mA	RL=∞All Op-Amps
		Full range	-	-	2		
High Level Output Voltage	VOH	25°C	3.5	-	-	V	RL=2[kΩ]
		Full range	-	-	-		VCC=30[V],RL=10[kΩ]
Low Level Output Voltage	VOL	Full range	-	5	20	mV	RL=∞All Op-Amps
Large Signal Voltage Gain	AV	25°C	25	100	-	V/mV	RL ≥ 2[kΩ],VCC=15[V] VOUT=1.4~11.4[V]
Input Common-mode Voltage Range	Vicm	25°C	0	-	VCC-1.5	V	(VCC-VEE)=5V,VOUT=VEE+1.4[V]
		Full range	-	-	-		
Common-mode Rejection Ratio	CMRR	25°C	50	80	-	dB	VOUT=1.4[V]
Power Supply Rejection Ratio	PSRR	25°C	65	100	-	dB	VCC=5~30[V]
Output Source Current (*5)	IOH	25°C	20	30	-	mA	VIN+=1[V],VIN-=0[V] VOUT=0[V] 1CH is short circuit
		Full range	10	-	-		
Output Sink Current (*5)	IOL	25°C	10	20	-	mA	VIN+=0[V],VIN-=1[V] VOUT=5[V] 1CH is short circuit
		Full range	2	-	-		
	I _{sink}	25°C	12	40	-	μA	VIN+=0[V],VIN-=1[V] VOUT=200[mV]
Channel Separation	CS	25°C	-	120	-	dB	f=1[kHz], input referred
Slew rate	SR	25°C	-	0.2	-	V/ μs	VCC=15[V],AV=0[V], RL=2[kΩ],CL=100[pF]
Maximum frequency	ft	25°C	-	0.5	-	MHz	VCC=30[V],RL=2[kΩ], CL=100[pF]
Input referred noise voltage	Vn	25°C	-	40	-	nV/(Hz) ^{1/2}	VCC=15[V],VEE=-15[V], RS=100[Ω],Vi=0[V],f=1[kHz]

(*4) Absolute value

(*5) Under high temperatures, please consider the power dissipation when selecting the output current.

When the output terminal is continuously shorted the output current reduces the internal temperature by flushing.

(*6) BA2904S family : Full range -40~105°C BA2904 family : Full range -40~+125°C

OBA2902S/BA2902 family (Unless otherwise specified VCC=+5[V], VEE=0[V])

Parameter	Symbol	Temperature Range	Guaranteed limit			Unit	Condition
			BA2902S/BA2902 family				
			Min.	Typ.	Max.		
Input Offset Voltage ^(*4)	Vio	25°C	-	2	7	mV	VOUT=1.4[V]
		Full range	-	-	10		VCC=5~30[V],VOUT=1.4[V]
Input Offset Voltage Drift	$\Delta V_{io}/\Delta T$		-	± 7	-	$\mu V/^{\circ}C$	VOUT=1.4[V]
Input Offset Current ^(*4)	Iio	25°C	-	2	50	nA	VOUT=1.4[V]
		Full range	-	-	200		
Input Offset Current Drift	$\Delta I_{io}/\Delta T$		-	± 10	-	$pA/^{\circ}C$	VOUT=1.4[V]
Input Bias Current ^(*4)	Ib	25°C	-	20	250	nA	VOUT=1.4[V]
		Full range	-	-	250		
Supply Current	Vicm	25°C	-	0.7	2	mA	RL=∞All Op-Amps
		Full range	-	-	3		
High Level Output Voltage	VOH	25°C	3.5	-	-	V	RL=2[kΩ]
		Full range	-	-	-		VCC=30[V],RL=10[kΩ]
Low Level Output Voltage	VOL	Full range	-	5	20	mV	RL=∞All Op-Amps
Large Signal Voltage Gain	AV	25°C	25	100	-	V/mV	RL≥2[kΩ],VCC=15[V] VOUT=1.4~11.4[V]
Input Common-mode Voltage Range	Vicm	25°C	0	-	VCC-1.5	V	(VCC-VEE)=5V,VOUT=VEE+1.4[V]
		Full range	-	-	-		
Common-mode Rejection Ratio	CMRR	25°C	50	80	-	dB	VOUT=1.4[V]
Power Supply Rejection Ratio	PSRR	25°C	65	100	-	dB	VCC=5~30[V]
Output Source Current ^(*5)	IOH	25°C	20	30	-	mA	VIN+=1[V],VIN-=0[V] VOUT=0[V] 1CH is short circuit
		Full range	10	-	-		
Output Sink Current ^(*5)	IOL	25°C	10	20	-	mA	VIN+=0[V],VIN-=1[V] VOUT=5[V] 1CH is short circuit
		Full range	2	-	-		
	I _{sink}	25°C	12	40	-	μA	VIN+=0[V],VIN-=1[V] VOUT=200[mV]
Channel Separation	CS	25°C	-	120	-	dB	f=1[kHz], input referred
Slew rate	SR	25°C	-	0.2	-	V/ μs	VCC=15[V],AV=0[V], RL=2[kΩ],CL=100[pF]
Maximum frequency	ft	25°C	-	0.5	-	MHz	VCC=30[V],RL=2[kΩ], CL=100[pF]
Input referred noise voltage	Vn	25°C	-	40	-	$nV/(Hz)^{1/2}$	VCC=15[V],VEE=-15[V], RS=100[Ω],Vi=0[V],f=1[kHz]

(*4) Absolute value

(*5) Under high temperatures, please consider the power dissipation when selecting the output current.

When the output terminal is continuously shorted the output current reduces the internal temperature by flushing.

(*6) BA2902S family : Full range -40~105°C ,BA2902 family : Full range -40~+125°C

OBA2904HFVM-C(Unless otherwise specified VCC=+5[V], VEE=0[V])

Parameter	Symbol	Temperature Range	Guaranteed limit			Unit	Condition
			BA2904HFVM-C				
			Min.	Typ.	Max.		
Input Offset Voltage ^(*4)	Vio	25°C	-	2	7	mV	VOUT=1.4[V]
		Full range	-	-	7		VCC=5~30[V],VOUT=1.4[V]
Input Offset Voltage Drift	$\Delta V_{io}/\Delta T$		-	-	-	$\mu V/^{\circ}C$	VOUT=1.4[V]
Input Offset Current ^(*4)	Iio	25°C	-	2	50	nA	VOUT=1.4[V]
		Full range	-	-	100		
Input Offset Current Drift	$\Delta I_{io}/\Delta T$		-	-	-	$pA/^{\circ}C$	VOUT=1.4[V]
Input Bias Current ^(*4)	Ib	25°C	-	20	60	nA	VOUT=1.4[V]
		Full range	-	-	100		
Supply Current	Vicm	25°C	-	0.7	1.2	mA	RL=∞All Op-Amps
		Full range	-	-	1.2		
High Level Output Voltage	VOH	25°C	3.5	-	-	V	RL=2[kΩ]
		Full range	3.2	-	-		VCC=30[V],RL=10[kΩ]
			27	28	-		
Low Level Output Voltage	VOL	Full range	-	5	20	mV	RL=∞All Op-Amps
Large Signal Voltage Gain	AV	25°C	-	-	-	V/mV	RL ≥ 2[kΩ],VCC=15[V] VOUT=1.4~11.4[V]
Input Common-mode Voltage Range	Vicm	25°C	0	-	VCC-1.5	V	(VCC-VEE)=5V,VOUT=VEE+1.4[V]
		Full range	0	-	VCC-2.0		
Common-mode Rejection Ratio	CMRR	25°C	65	80	-	dB	VOUT=1.4[V]
Power Supply Rejection Ratio	PSRR	25°C	65	100	-	dB	VCC=5~30[V]
Output Source Current ^(*5)	IOH	25°C	20	30	-	mA	VIN+=1[V],VIN-=0[V] VOUT=0[V] 1CH is short circuit
		Full range	10	-	-		
Output Sink Current ^(*5)	IOL	25°C	10	20	-	mA	VIN+=0[V],VIN-=1[V] VOUT=5[V] 1CH is short circuit
		Full range	2	-	-		
	I _{sink}	25°C	12	40	-	μA	VIN+=0[V],VIN-=1[V] VOUT=200[mV]
Channel Separation	CS	25°C	-	-	-	dB	f=1[kHz], input referred
Slew rate	SR	25°C	-	-	-	V/ μs	VCC=15[V],AV=0[V], RL=2[kΩ],CL=100[pF]
Maximum frequency	ft	25°C	-	-	-	MHz	VCC=30[V],RL=2[kΩ], CL=100[pF]
Input referred noise voltage	Vn	25°C	-	-	-	$nV/(Hz)^{1/2}$	VCC=15[V],VEE=-15[V], RS=100[Ω],Vi=0[V],f=1[kHz]

(*4) Absolute value

(*5) Under high temperatures, please consider the power dissipation when selecting the output current.

When the output terminal is continuously shorted the output current reduces the internal temperature by flushing.

(*6) BA2904HFVM-C : Full range -40~+125°C

●Absolute Maximum Ratings (Ta=25[°C])
OBA3404 family

Parameter	Symbol	Rating	Unit
Supply Voltage	VCC-VEE	+36	V
Differential Input Voltage ^(*7)	Vid	36	V
Input Common-mode Voltage Range	Vicm	(VEE-0.3)~(VEE+36)	V
Operating Temperature Range	Topr	-40~+85	°C
Storage Temperature Range	Tstg	-55~+150	°C
Maximum Junction Temperature	Tjmax	+150	°C

Note Absolute maximum rating item indicates the condition which must not be exceeded.

Application if voltage in excess of absolute maximum rating or use out of absolute maximum rated temperature environment may cause deterioration of characteristics.

(*7) The voltage difference between inverting input and non-inverting input is the differential input voltage.
Then input terminal voltage is set to more than VEE.

●Electric Characteristics

OBA3404 family (Unless otherwise specified VCC=+15[V], VEE=-15[V], Ta=25[°C])

Parameter	Symbol	Temperature Range	Guaranteed limit			Unit	Condition
			Min.	Typ.	Max.		
Input Offset Voltage ^(*8)	Vio	25°C	-	2	5	mV	VOUT=0[V], Vicm=0[V]
Input Offset Current ^(*8)	Iio	25°C	-	5	50	nA	VOUT=0[V], Vicm=0[V]
Input Bias Current ^(*8)	Ib	25°C	-	70	200	nA	VOUT=0[V], Vicm=0[V]
Large Signal Voltage Gain	AV	25°C	88	100	-	dB	RL ≥ 2[kΩ], VOUT=±10[V], Vicm=0[V]
Maximum Output Voltage	VOM	25°C	±13	±14	-	V	RL ≥ 2[kΩ]
Input Common-mode Voltage Range	Vicm	25°C	-15	-	13	V	VOUT=0[V]
Common-mode Rejection Ratio	CMRR	25°C	70	90	-	dB	VOUT=0[V], Vicm=-15[V]~+13[V]
Power Supply Rejection Ratio	PSRR	25°C	80	94	-	dB	Ri ≤ 10[kΩ], VCC=+4[V]~+30[V]
Supply Current	ICC	25°C	-	2.0	3.5	mA	RL=∞ All Op-Amps, VIN+=0[V]
Output Source Current	Isource	25°C	20	30	-	mA	VIN+=1[V], VIN-=0[V], VOUT=+12[V], Output of one channel only
Output Sink Current	Isink	25°C	10	20	-	mA	VIN+=0[V], VIN-=1[V], VOUT=-12[V], Output of one channel only
Slew rate	SR	25°C	-	1.2	-	V/μs	AV=0[dB], RL=2[kΩ], CL=100[pF]
Unity Gain Frequency	ft	25°C	-	1.2	-	MHz	RL=2[kΩ]
Total Harmonic Distortion	THD	25°C	-	0.1	-	%	VOUT=10[Vp-p], f=20[kHz], AV=0[dB], RL=2[kΩ]

(*8) Absolute value

● Example of electrical characteristics

OBA10358 family

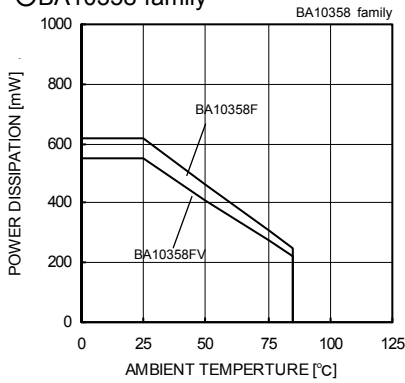

Fig. 1 Derating Curve

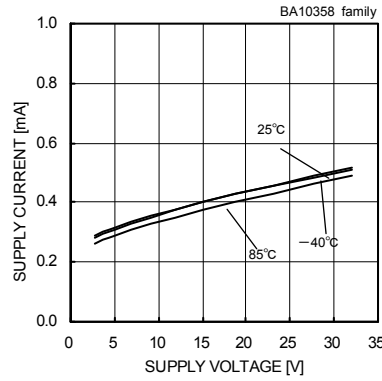

Fig. 2 Supply Current - Supply Voltage

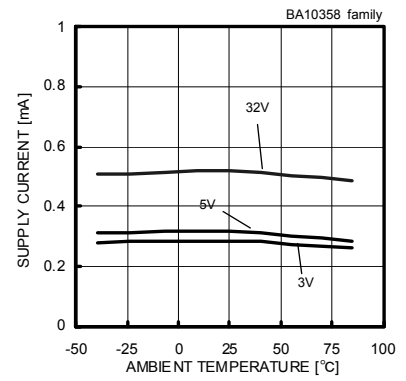

Fig. 3 Supply Current - Ambient Temperature

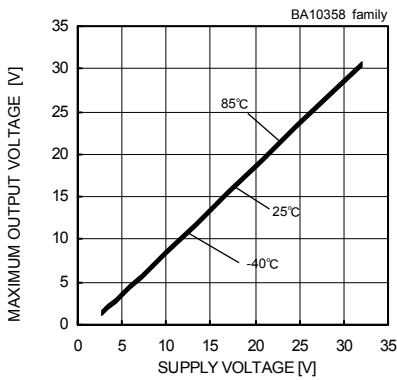

Fig. 4 Maximum Output Voltage - Supply Voltage (RL=10[kΩ])

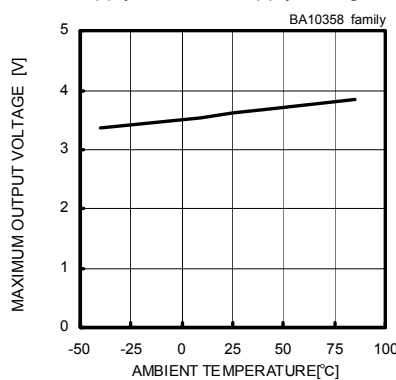

Fig. 5 Maximum Output Voltage - Ambient Temperature (VCC=5[V], RL=2[kΩ])

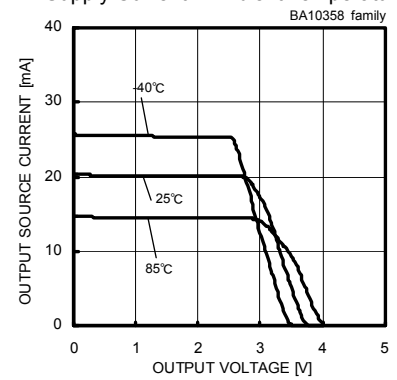

Fig. 6 Output Source Current - Output Voltage (VCC=5[V])

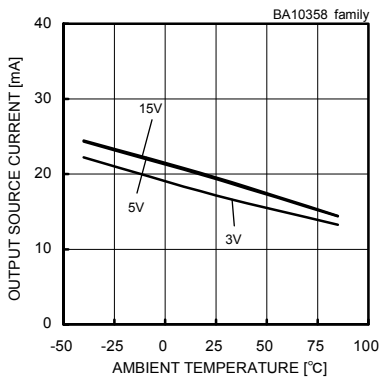

Fig. 7 Output Source Current - Ambient Temperature (VOUT=0[V])

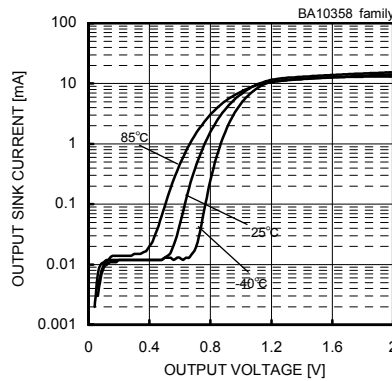

Fig. 8 Output Sink Current - Output Voltage (VCC=5[V])

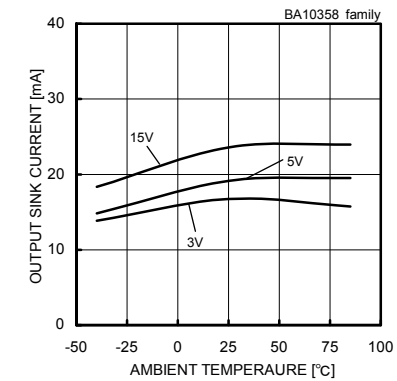

Fig. 9 Output Sink Current - Ambient Temperature (VOUT=VCC)

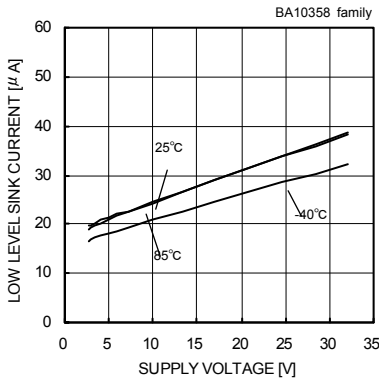

Fig. 10 Low Level Sink Current - Supply Voltage (VOUT=0.2[V])

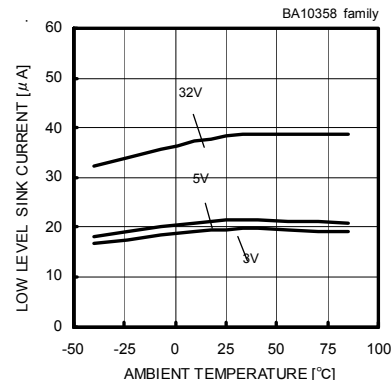

Fig. 11 Low Level Sink Current - Ambient Temperature (VOUT=0.2[V])

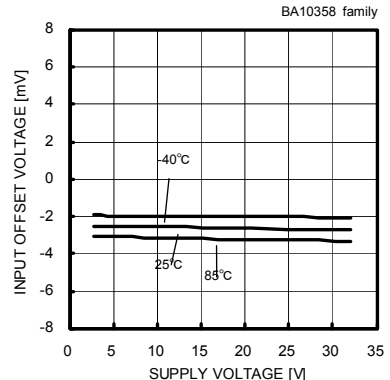

Fig. 12 Input Offset Voltage - Supply Voltage (Vicm=0[V], VOUT=1.4[V])

(*)The data above is ability value of sample, it is not guaranteed.

OBA10358 family

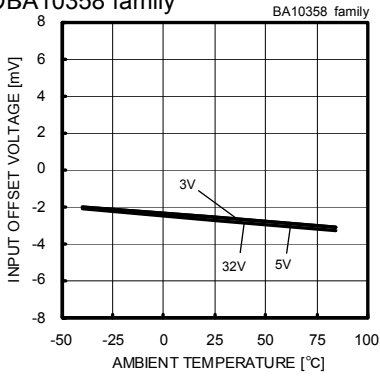

Fig. 13

Input Offset Voltage – Ambient Temperature
(Vicm=0[V], VOUT=1.4[V])

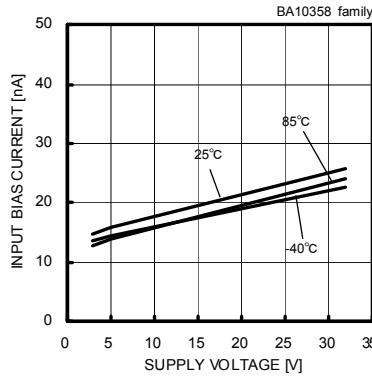

Fig. 14

Input Bias Current – Supply Voltage
(Vicm=0[V], VOUT=1.4[V])

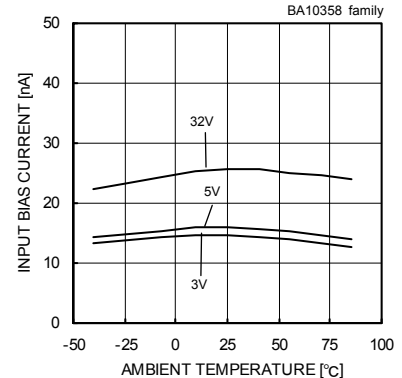

Fig. 15

Input Bias Current – Ambient Temperature
(Vicm=0[V], VOUT=1.4[V])

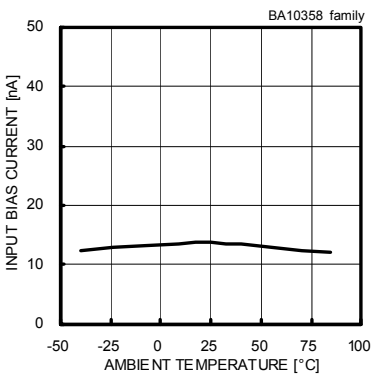

Fig. 16

Input Bias Current – Ambient Temperature
(VCC=30[V], Vicm=28[V], VOUT=1.4[V])

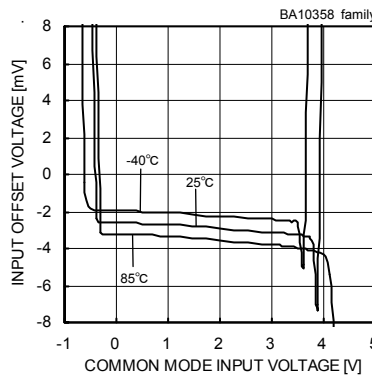

Fig. 17

Input Offset Voltage
– Common Mode Input Voltage
(VCC=5[V])

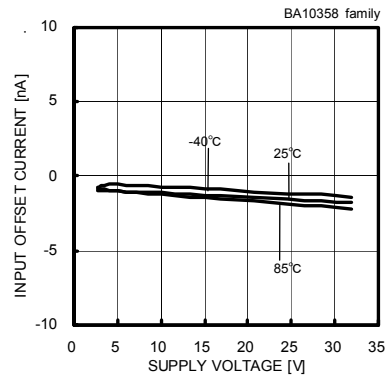

Fig. 18

Input Offset Current – Supply Voltage
(Vicm=0[V], VOUT=1.4[V])

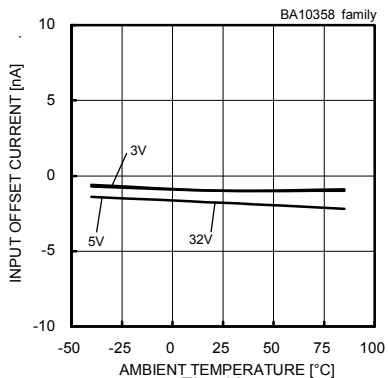

Fig. 19

Input Offset Current – Ambient Temperature
(Vicm=0[V], VOUT=1.4[V])

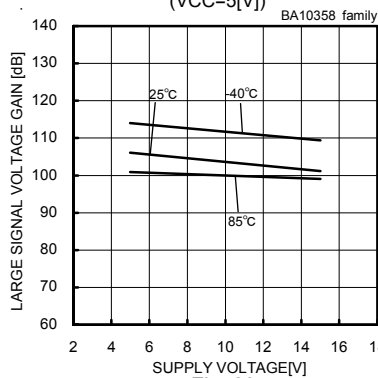

Fig. 20

Large Signal Voltage Gain – Supply Voltage
(RL=2[kΩ])

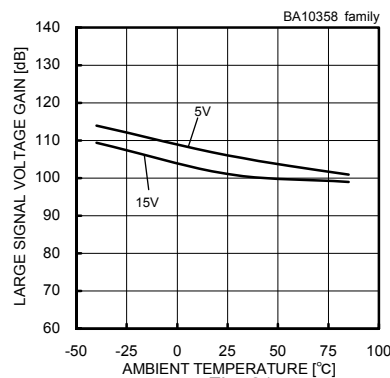

Fig. 21

Large Signal Voltage Gain
– Ambient Temperature
(RL=2[kΩ])

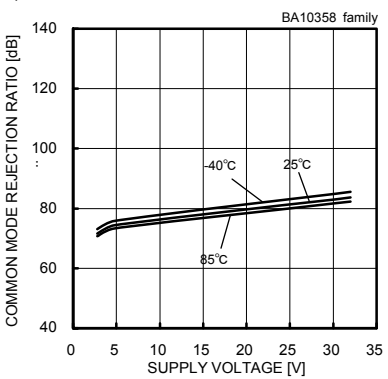

Fig. 22

Common Mode Rejection Ratio
– Supply Voltage

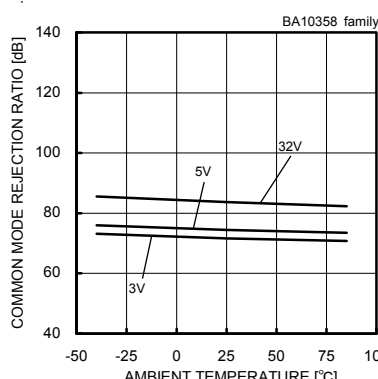

Fig. 23

Common Mode Rejection Ratio
– Ambient Temperature

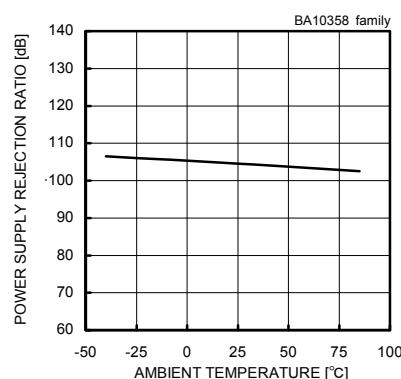

Fig. 24

Power Supply Rejection Ratio
– Ambient Temperature

(*)The data above is ability value of sample, it is not guaranteed.

OBA10324A family

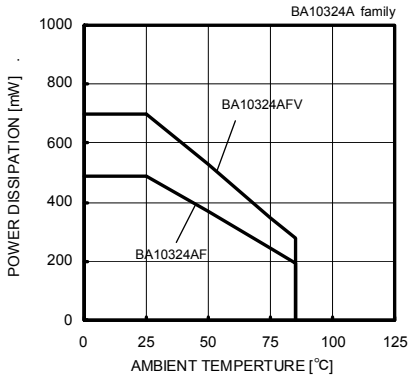

Fig. 25 Derating Curve

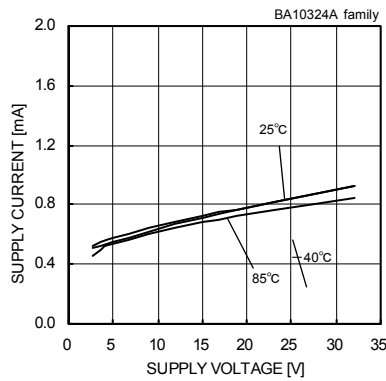

Fig. 26 Supply Current - Supply Voltage

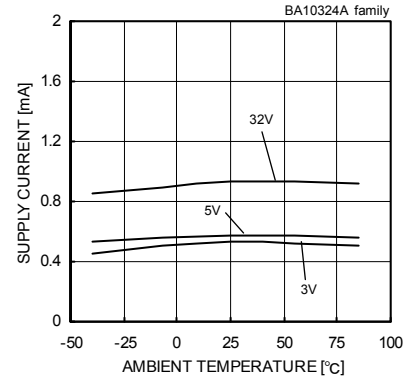

Fig. 27 Supply Current - Ambient Temperature

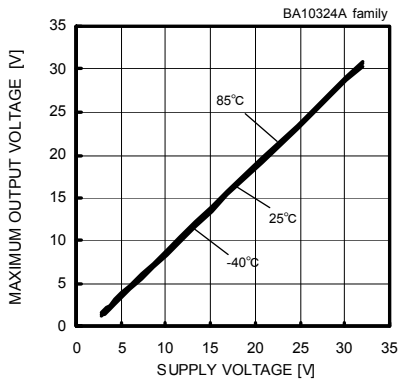

Fig. 28 Maximum Output Voltage - Supply Voltage (RL=10[kΩ])

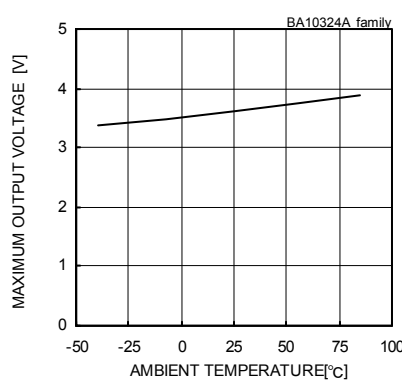

Fig. 29 Maximum Output Voltage - Ambient Temperature (VCC=5[V],RL=2[kΩ])

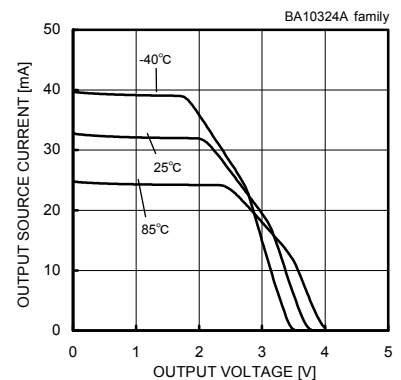

Fig. 30 Output Source Current - Output Voltage (VCC=5[V])

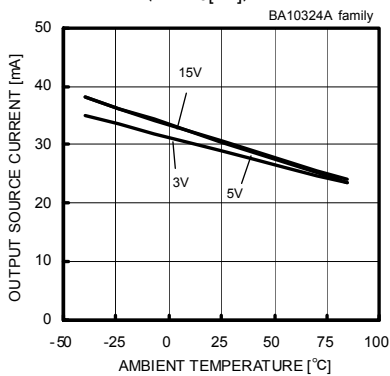

Fig. 31 Output Source Current - Ambient Temperature (VOUT=0[V])

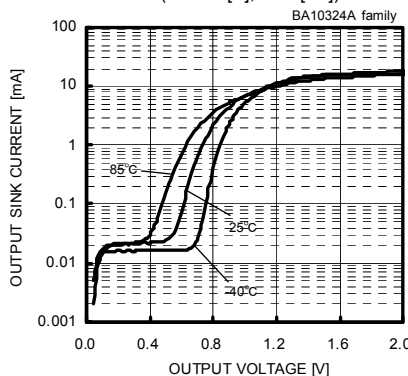

Fig. 32 Output Sink Current - Output Voltage (VCC=5[V])

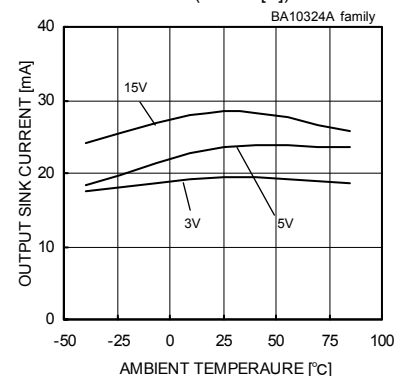

Fig. 33 Output Sink Current - Ambient Temperature (VOUT=VCC)

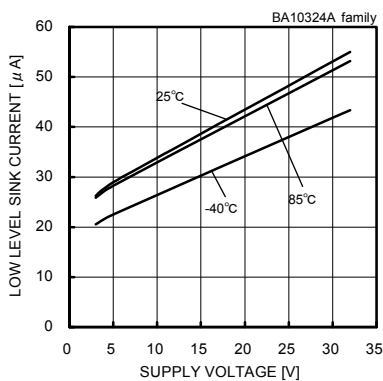

Fig. 34 Low Level Sink Current - Supply Voltage (VOUT=0.2[V])

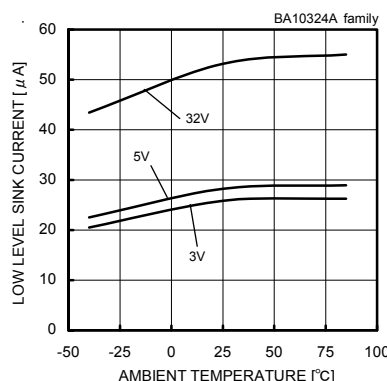

Fig. 35 Low Level Sink Current - Ambient Temperature (VOUT=0.2[V])

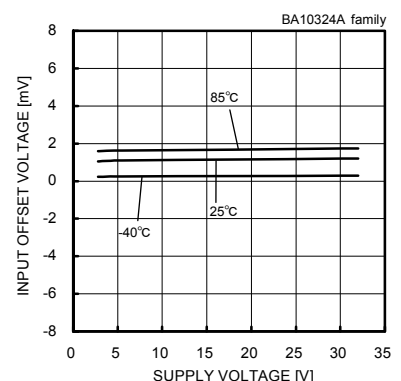

Fig. 36 Input Offset Voltage - Supply Voltage (Vicm=0[V], VOUT=1.4[V])

(*)The data above is ability value of sample, it is not guaranteed.

BA10324A family

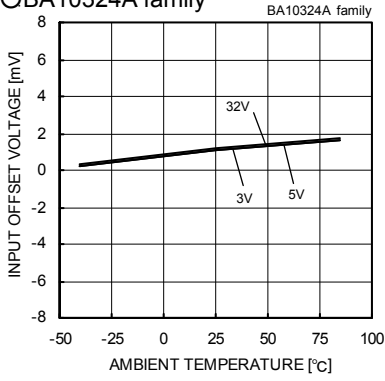

Fig. 37

Input Offset Voltage – Ambient Temperature
($V_{icm}=0[V]$, $V_{OUT}=1.4[V]$)

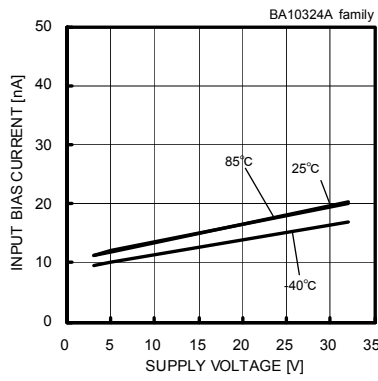

Fig. 38

Input Bias Current – Supply Voltage
($V_{icm}=0[V]$, $V_{OUT}=1.4[V]$)

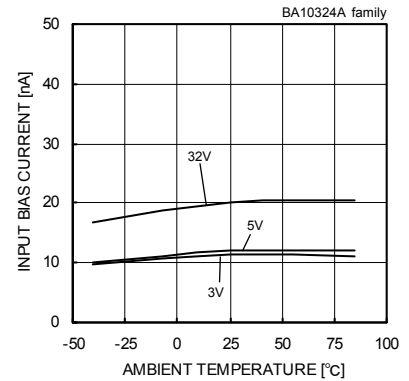

Fig. 39

Input Bias Current – Ambient Temperature
($V_{icm}=0[V]$, $V_{OUT}=1.4[V]$)

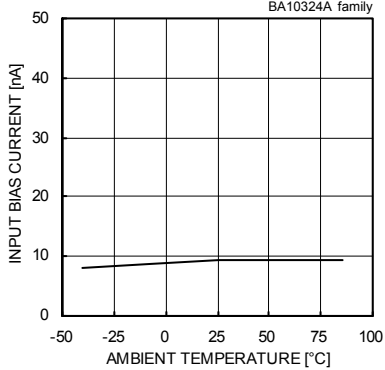

Fig. 40

Input Bias Current – Ambient Temperature
($V_{CC}=30[V]$, $V_{icm}=28[V]$, $V_{OUT}=1.4[V]$)

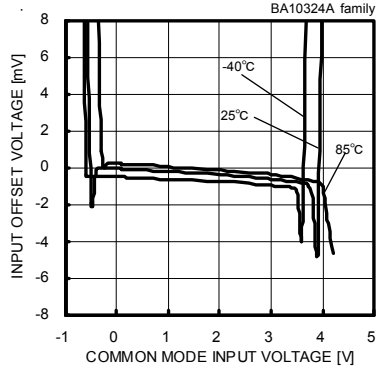

Fig. 41

Input Offset Voltage – Common Mode
Input Voltage ($V_{CC}=5[V]$)

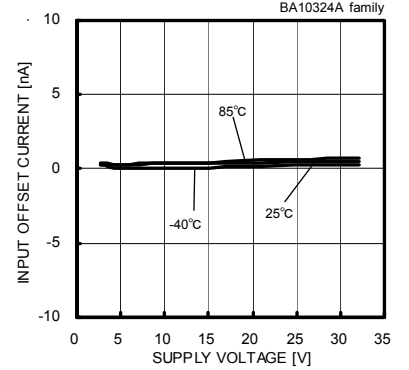

Fig. 42

Input Offset Current – Supply
Voltage ($V_{icm}=0[V]$, $V_{OUT}=1.4[V]$)

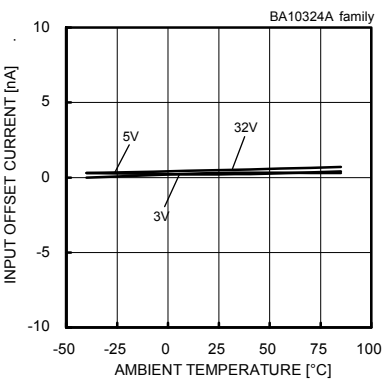

Fig. 43

Input Offset Current – Ambient Temperature
($V_{icm}=0[V]$, $V_{OUT}=1.4[V]$)

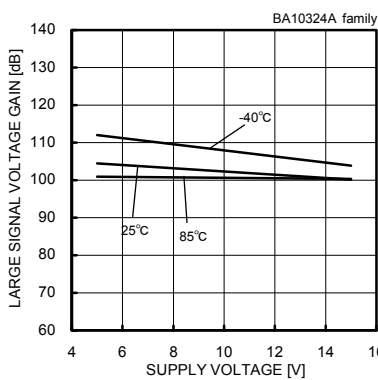

Fig. 44

Large Signal Voltage Gain – Supply Voltage
($R_L=2[k\Omega]$)

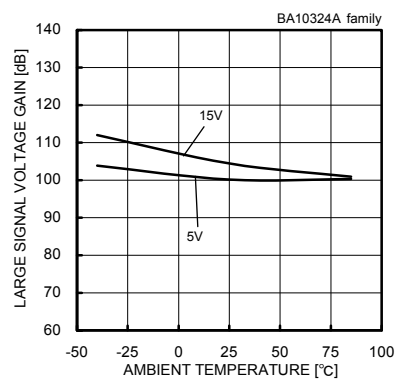

Fig. 45

Large Signal Voltage Gain – Ambient
Temperature ($R_L=2[k\Omega]$)

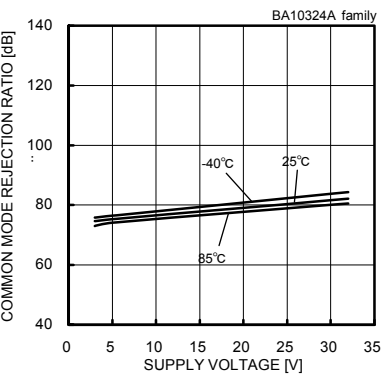

Fig. 46

Common Mode Rejection Ratio
– Supply Voltage

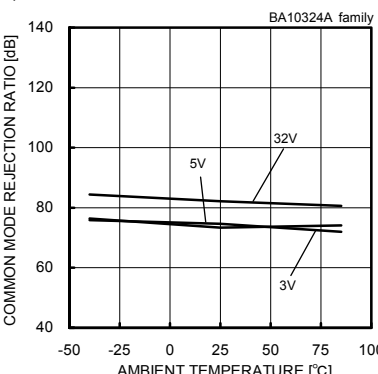

Fig. 47

Common Mode Rejection Ratio
– Ambient Temperature

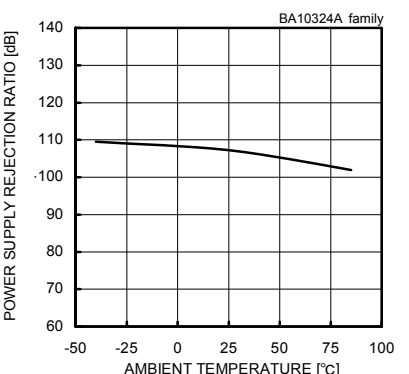

Fig. 48

Power Supply Rejection Ratio
– Ambient Temperature

(*)The data above is ability value of sample, it is not guaranteed.

OBA2904S/BA2904 family,BA2904HFVM-C

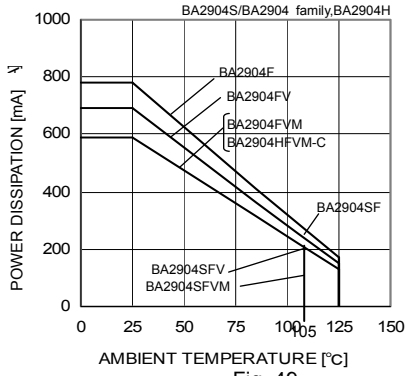

Fig. 49
Derating Curve

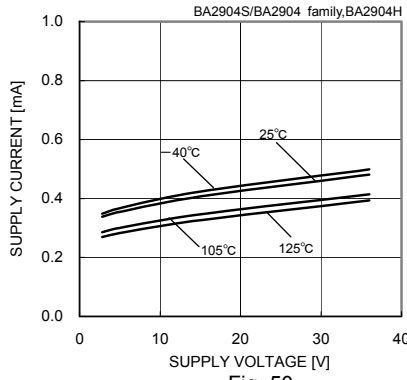

Fig. 50
Supply Current - Supply Voltage

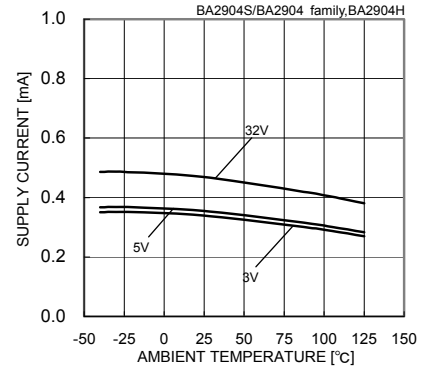

Fig. 51
Supply Current - Ambient Temperature

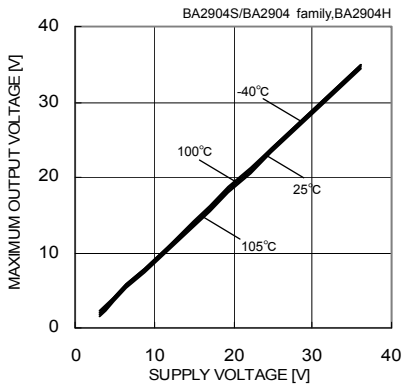

Fig. 52
Maximum Output Voltage
- Supply Voltage (RL=10[kΩ])

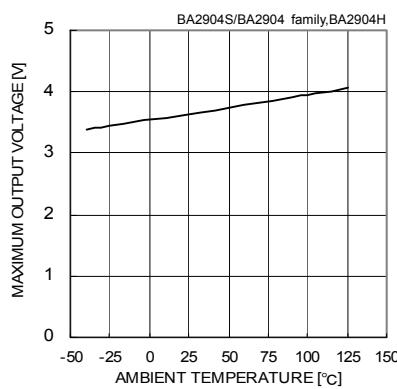

Fig. 53
Maximum Output Voltage - Ambient
Temperature (VCC=5[V],RL=2[kΩ])

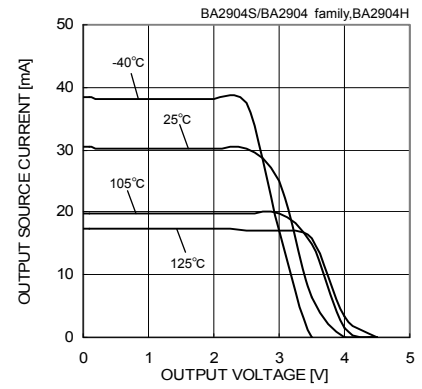

Fig. 54
Output Source Current
- Output Voltage (VCC=5[V])

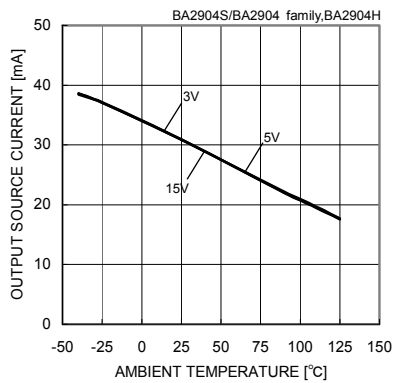

Fig. 55
Output Source Current - Ambient Temperature
(VOUT=0[V])

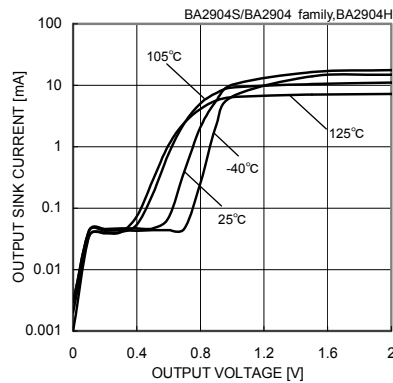

Fig. 56
Output Sink Current - Output Voltage
(VCC=5[V])

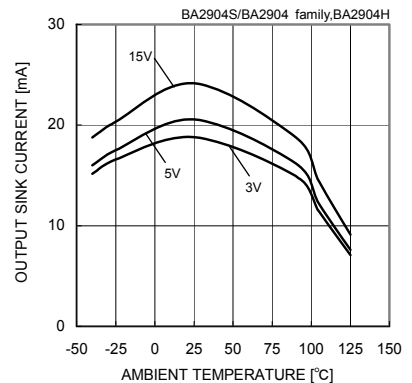

Fig. 57
Output Sink Current - Ambient Temperature
(VOUT=VCC)

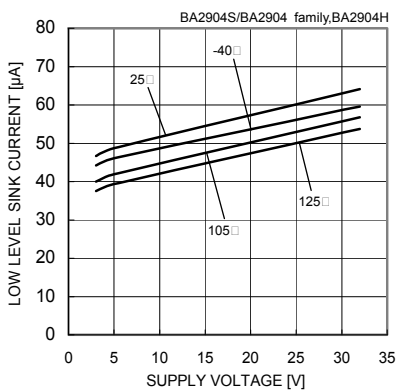

Fig. 58
Low Level Sink Current
- Supply Voltage (VOUT=0.2[V])

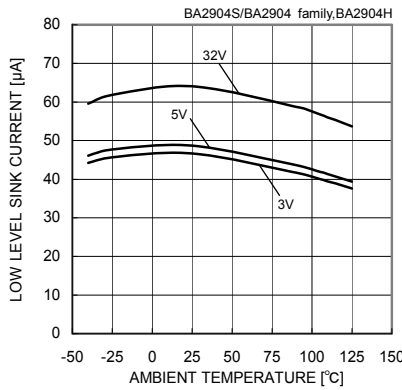

Fig. 59
Low Level Sink Current
- Ambient Temperature (VOUT=0.2[V])

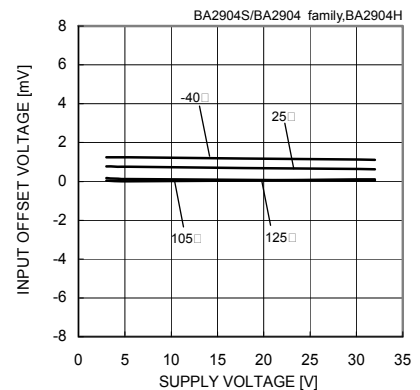

Fig. 60
Input Offset Voltage
- Supply Voltage (VICM=0[V], VOUT=1.4[V])

(*)The data above is ability value of sample, it is not guaranteed.

○BA2904S/BA2904 family,BA2904HFVM-C

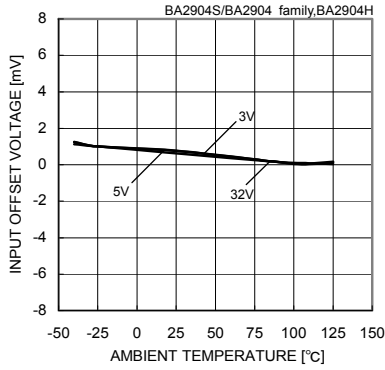

Fig. 61

Input Offset Voltage – Ambient Temperature
(Vicm=0[V], VOUT=1.4[V])

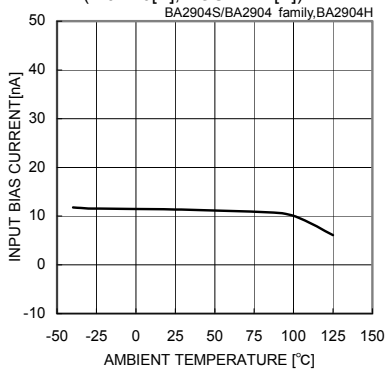

Fig. 64

Input Bias Current - Ambient Temperature
(VCC=30[V], Vicm=28[V], VOUT=1.4[V])

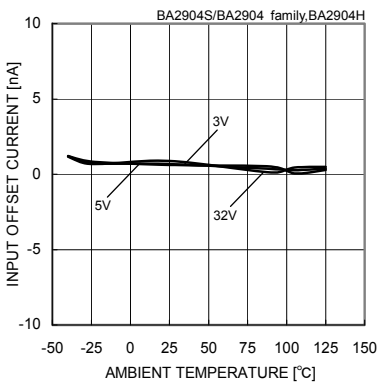

Fig. 67

Input Offset Current
– Ambient Temperature (Vicm=0[V], VOUT=1.4[V])

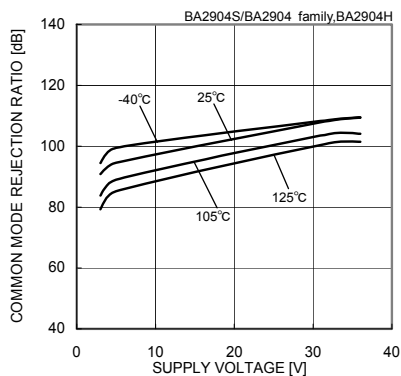

Fig. 70

Common Mode Rejection Ratio
- Supply Voltage

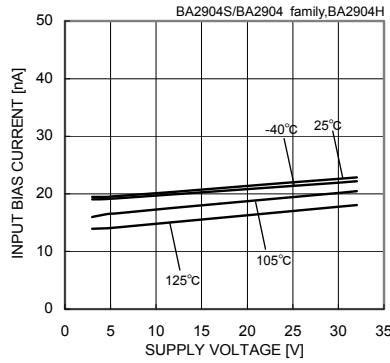

Fig. 62

Input Bias Current – Supply Voltage
(Vicm=0[V], VOUT=1.4[V])

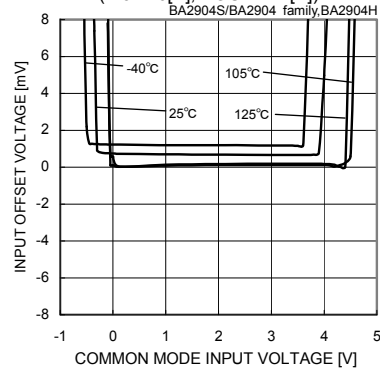

Fig. 65

Input Offset Voltage - Common Mode
Input Voltage (VCC=5[V])

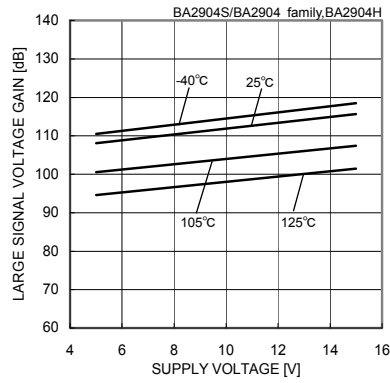

Fig. 68

Large Signal Voltage Gain
– Supply Voltage (RL=2[kΩ])

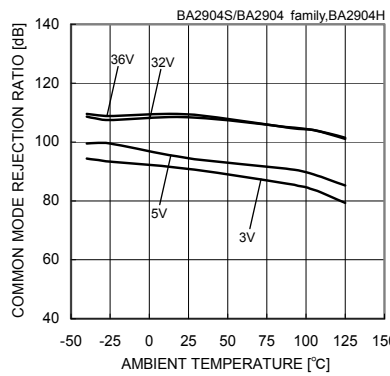

Fig. 71

Common Mode Rejection Ratio
- Ambient Temperature

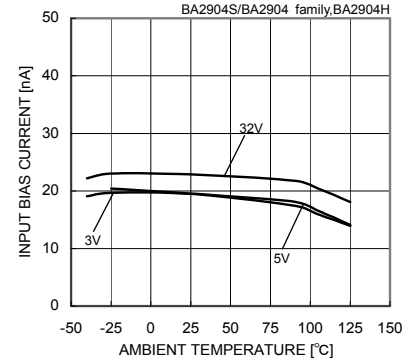

Fig. 63

Input Bias Current – Ambient Temperature
(Vicm=0[V], VOUT=1.4[V])

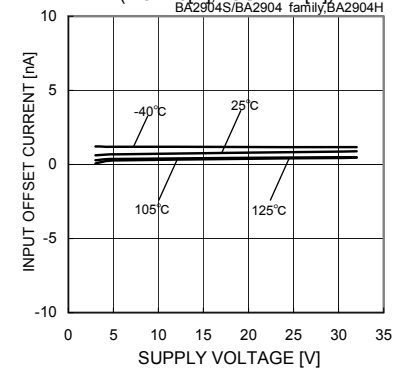

Fig. 66

Input Offset Current – Supply Voltage
(Vicm=0[V], VOUT=1.4[V])

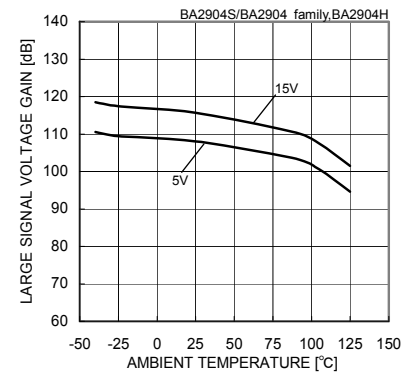

Fig. 69

Large Signal Voltage Gain
– Ambient Temperature (RL=2[kΩ])

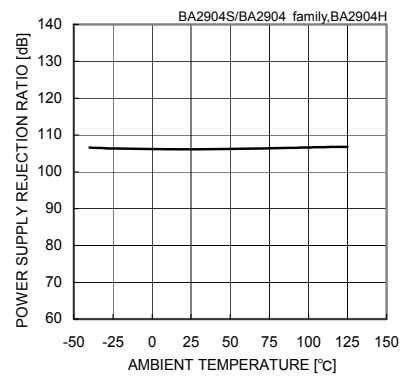

Fig. 72

Power Supply Rejection Ratio
- Ambient Temperature

(*)The data above is ability value of sample, it is not guaranteed.

OBA2902S/BA2902 family

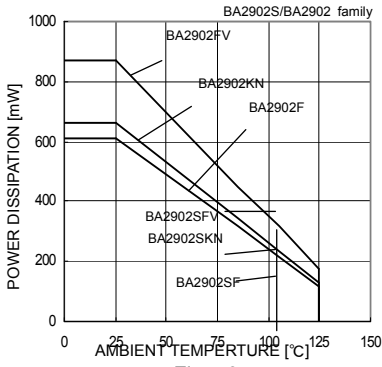

Fig. 73 Derating Curve

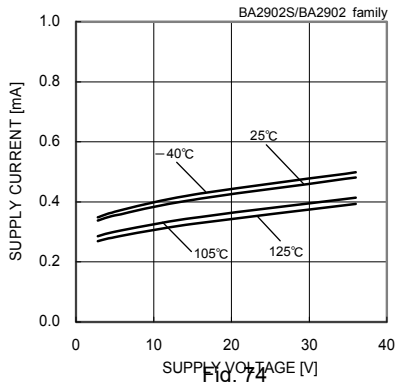

Fig. 74 Supply Current - Supply Voltage

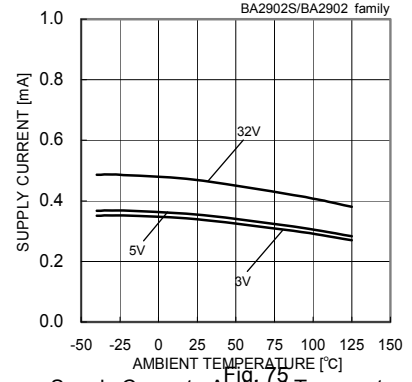

Fig. 75 Supply Current - Ambient Temperature

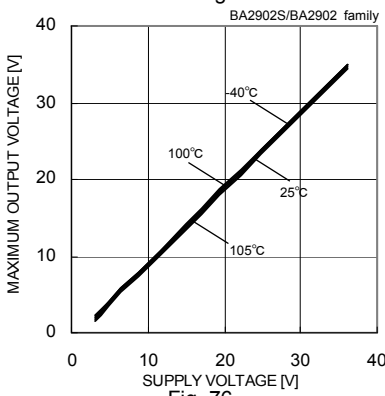

Fig. 76 Maximum Output Voltage - Supply Voltage (RL=10[kΩ])

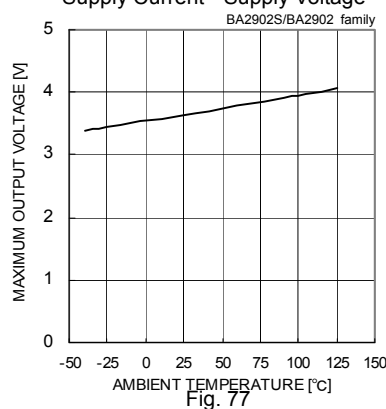

Fig. 77 Maximum Output Voltage - Ambient Temperature (VCC=5[V], RL=2[kΩ])

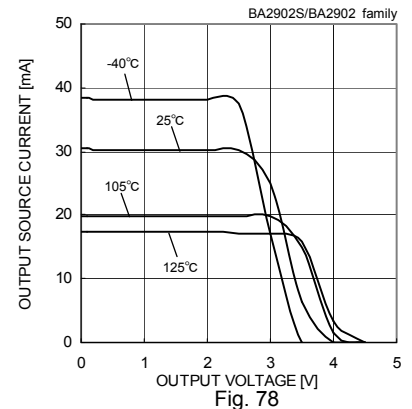

Fig. 78 Output Source Current - Output Voltage (VCC=5[V])

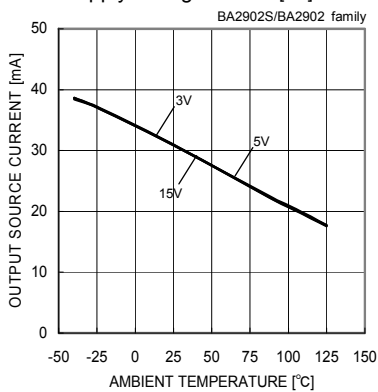

Fig. 79 Output Source Current - Ambient Temperature (VOUT=0[V])

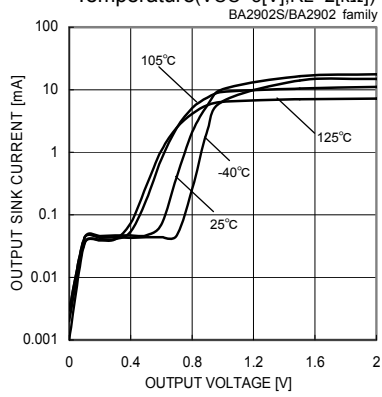

Fig. 80 Output Sink Current - Output Voltage (VCC=5[V])

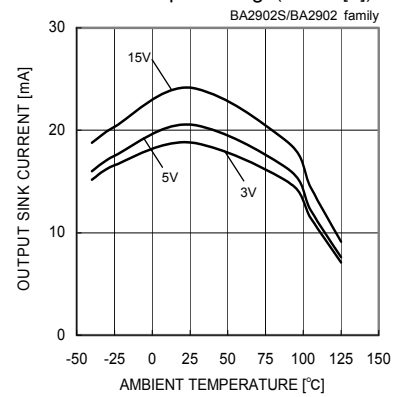

Fig. 81 Output Sink Current - Ambient Temperature (VOUT=VCC)

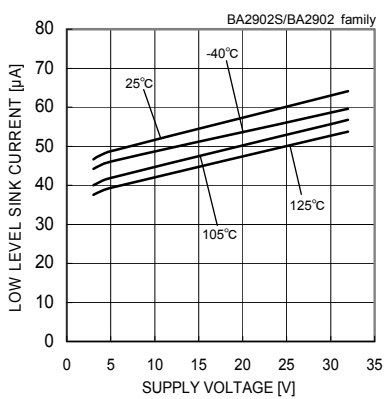

Fig. 82 Low Level Sink Current - Supply Voltage (VOUT=0.2[V])

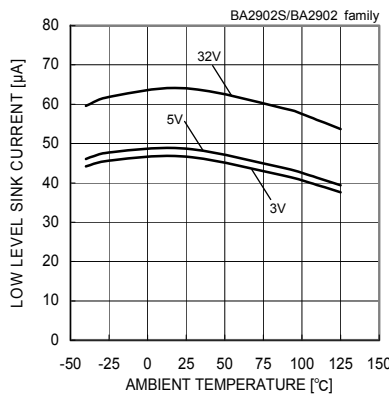

Fig. 83 Low Level Sink Current - Ambient Temperature (VOUT=0.2[V])

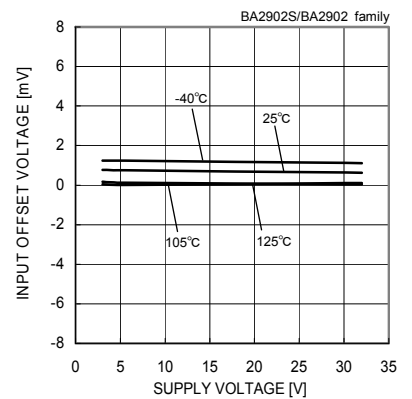

Fig. 84 Input Offset Voltage - Supply Voltage (Vcm=0[V], VOUT=1.4[V])

(*)The data above is ability value of sample, it is not guaranteed.

○BA2902S/BA2902 family

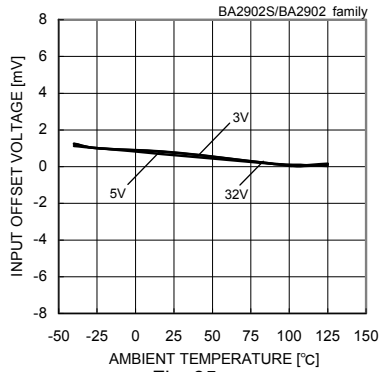

Fig. 85

Input Offset Voltage – Ambient Temperature
(Vicm=0[V], VOUT=1.4[V])

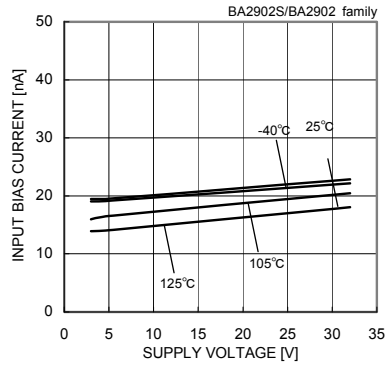

Fig. 86

Input Bias Current – Supply Voltage
(Vicm=0[V], VOUT=1.4[V])

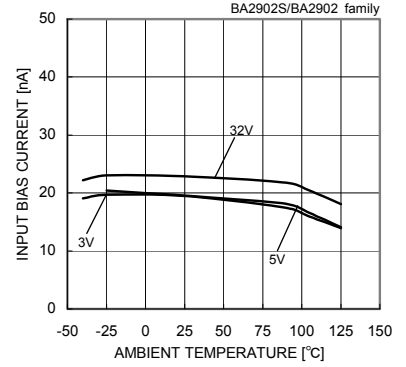

Fig. 87

Input Bias Current – Ambient Temperature
(Vicm=0[V], VOUT=1.4[V])

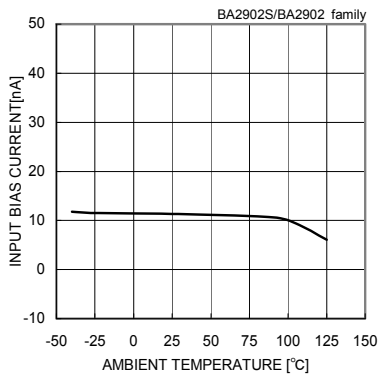

Fig. 88

Input Bias Current – Ambient Temperature
(VCC=30[V], Vicm=28[V], VOUT=1.4[V])

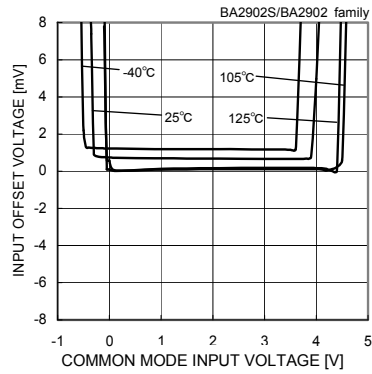

Fig. 89

Input Offset Voltage – Common Mode
Input Voltage(VCC=5[V])

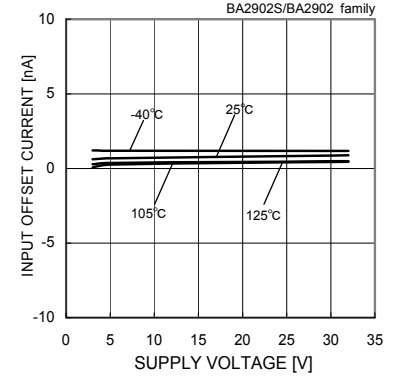

Fig. 90

Input Offset Current – Supply Voltage
(Vicm=0[V], VOUT=1.4[V])

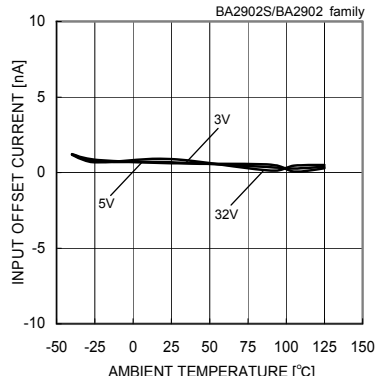

Fig. 91

Input Offset Current – Ambient Temperature
(Vicm=0[V], VOUT=1.4[V])

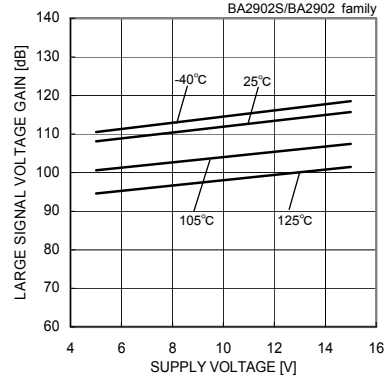

Fig. 92

Large Signal Voltage Gain
– Supply Voltage(RL=2[kΩ])

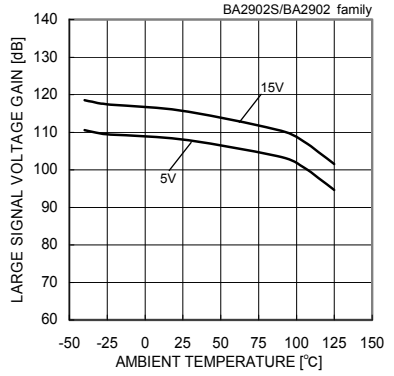

Fig. 93

Large Signal Voltage Gain
– Ambient Temperature(RL=2[kΩ])

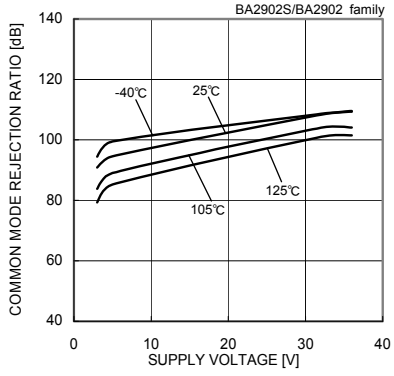

Fig. 94

Common Mode Rejection Ratio
– Supply Voltage

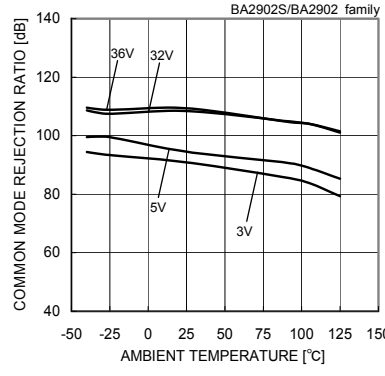

Fig. 95

Common Mode Rejection Ratio
– Ambient Temperature

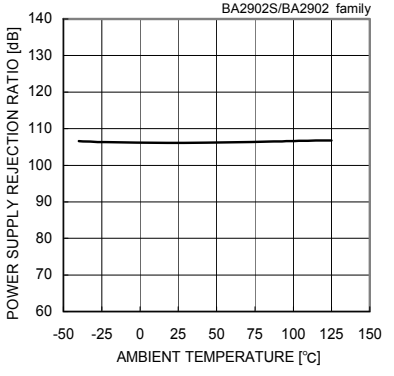

Fig. 96

Power Supply Rejection Ratio
– Ambient Temperature

(*)The data above is ability value of sample, it is not guaranteed.

○BA3404 family

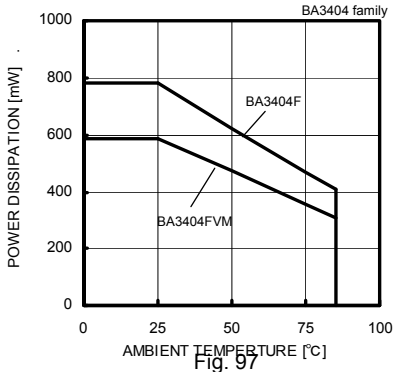

Fig. 97 Derating Curve

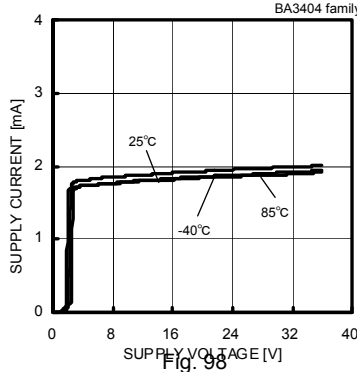

Fig. 98 Supply Current - Supply Voltage

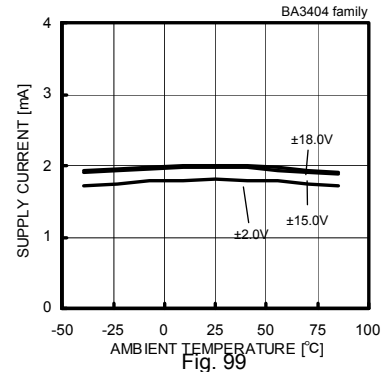

Fig. 99 Supply Current - Ambient Temperature

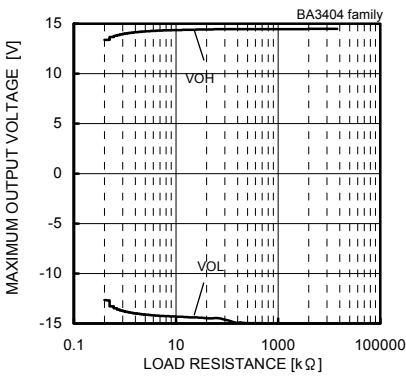

Fig. 100

Maximum Output Voltage – Load Resistance
(VCC/VEE=+15[V]/-15[V], Ta=25[°C])

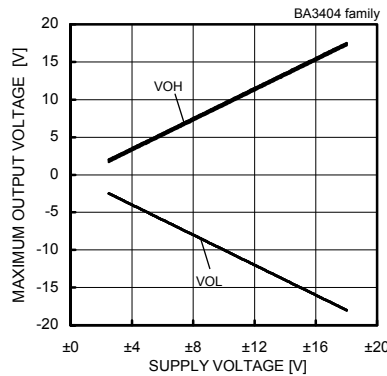

Fig. 101

Maximum Output Voltage – Supply Voltage

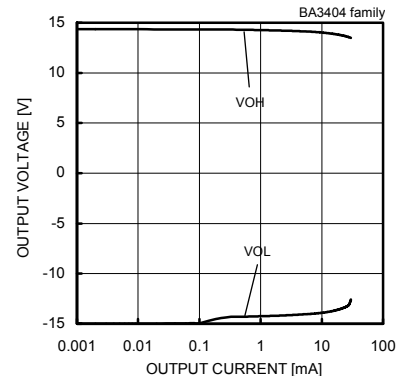

Fig. 102

Output Voltage – Output Current
(VCC/VEE=+15[V]/-15[V], Ta=25[°C])

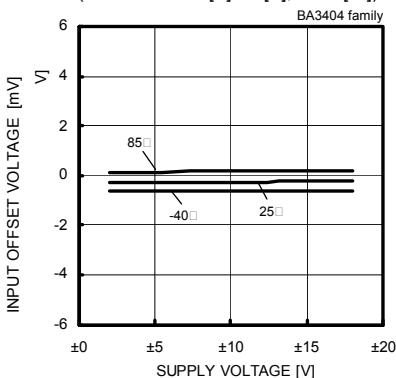

Fig. 103

Input Offset Voltage - Supply voltage
(Vicm=0[V], VOUT=0[V])

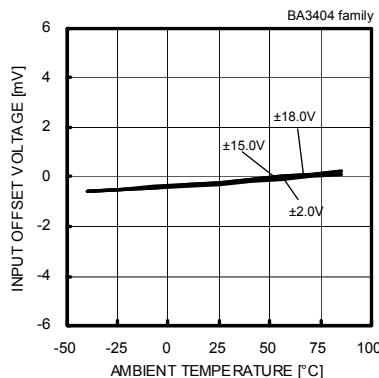

Fig. 104

Input Offset Voltage - Ambient Temperature
(Vicm=0[V], VOUT=0[V])

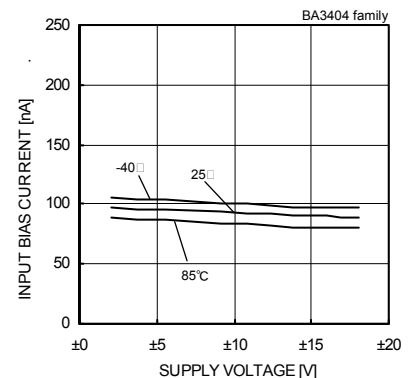

Fig. 105

Input Bias Current - Supply Voltage
(Vicm=0[V], VOUT=0[V])

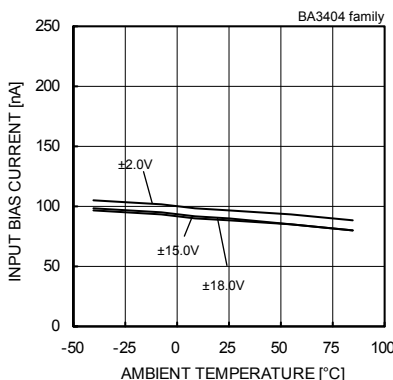

Fig. 106

Input Bias Current – Ambient Temperature
(Vicm=0[V], VOUT=0[V])

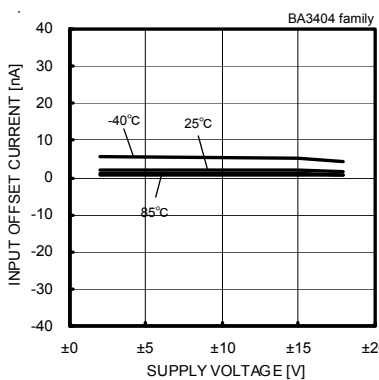

Fig. 107

Input Offset Current – Supply Voltage
(Vicm=0[V], VOUT=0[V])

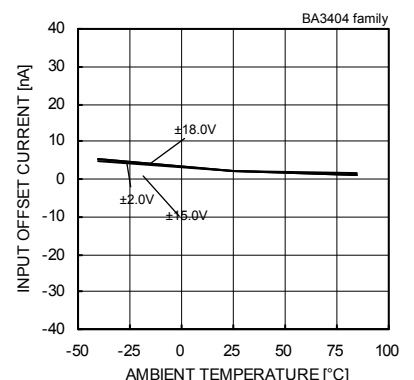

Fig. 108

Input Offset Current – Ambient Temperature
(Vicm=0[V], VOUT=0[V])

(*)The data above is ability value of sample, it is not guaranteed.

○BA3404 family

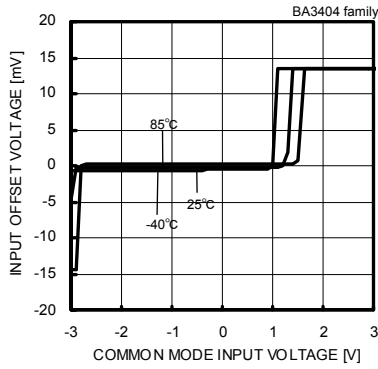

Fig. 109
Input Offset Voltage
– Common Mode Input Voltage
(VCC/VEE=+2.5[V]/-2.5[V])

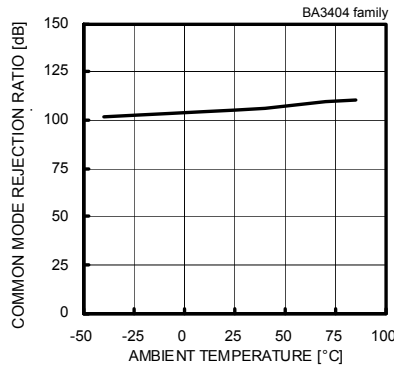

Fig. 110
Common Mode Rejection Ratio
– Ambient Temperature
(VCC/VEE=+15[V]/-15[V])

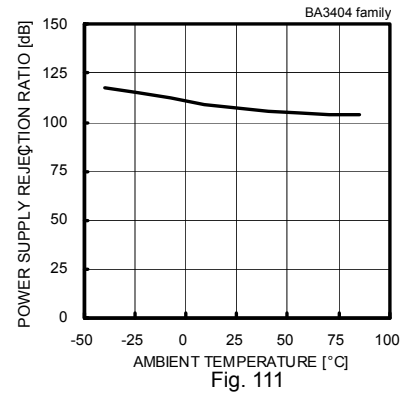

Fig. 111
Power Supply Rejection Ratio
– Ambient Temperature
(VCC/VEE=+15[V]/-15[V])

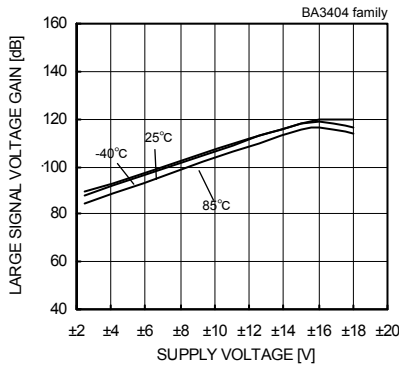

Fig. 112
Large Signal Voltage Gain
– Supply Voltage
(RL=2[kΩ])

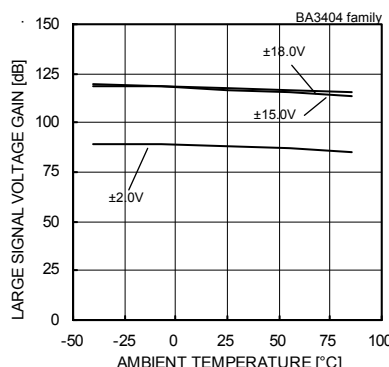

Fig. 113
Large Signal Voltage Gain
– Ambient Temperature
(RL=2[kΩ])

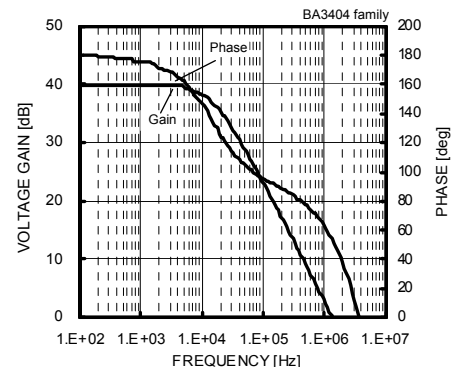

Fig. 114
Voltage Gain - Frequency
(VCC=±15V)

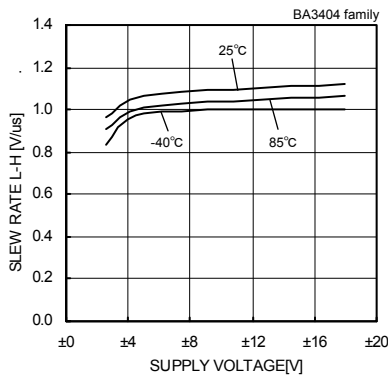

Fig. 115
Slew Rate L-H – Supply Voltage

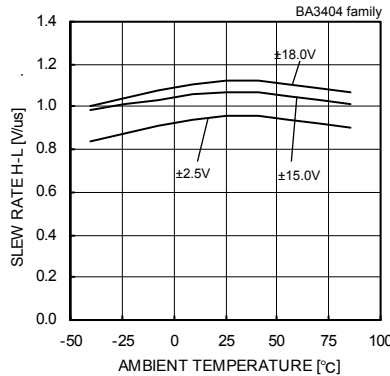

Fig. 116
Slew Rate H-L – Ambient Temperature

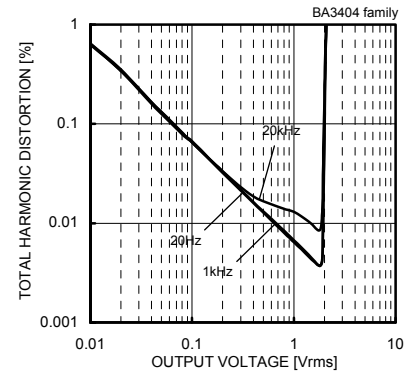

Fig. 117
Total Harmonic Distortion – Output Voltage
(VCC/VEE=+4[V]/-4[V], Av=0[dB],
RL=2[kΩ], 80[kHz]-LPF, Ta=25[°C])

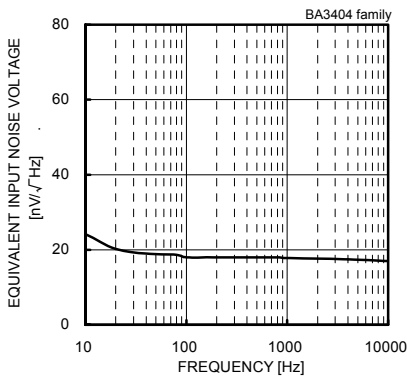

Fig. 118
Equivalent Input Noise Voltage - Frequency
(VCC/VEE=+15[V]/-15[V], Rs=100[Ω], Ta=25[°C])

(*)The data above is ability value of sample, it is not guaranteed.

●Circuit Diagram

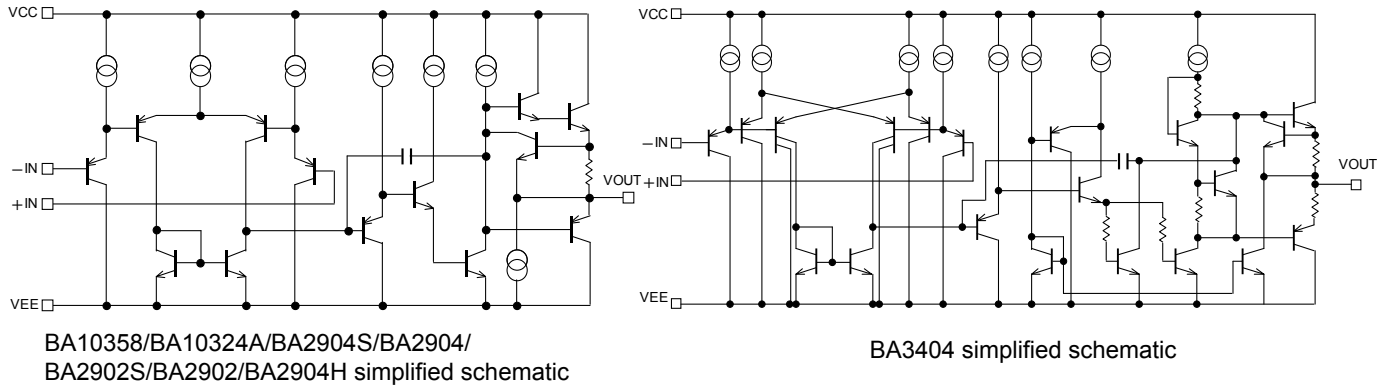

Fig. 119 Circuit Diagram (one channel only)

●Test circuit1 NULL method

VCC,VEE,EK, Vicm Unit : [V]

Parameter	VF	S1	S2	S3	BA10358/BA10324A family				BA2904S/BA2904 family BA2902S/BA2902 family BA2904HFVM-C				BA3404 family				Calculation
					Vcc	VEE	EK	Vicm	Vcc	VEE	EK	Vicm	VCC	VEE	EK	Vicm	
Input Offset Voltage	VF1	ON	ON	OFF	5	0	-1.4	0	5~30	0	-1.4	0	15	-15	0	0	1
Input Offset Current	VF2	OFF	OFF	OFF	5	0	-1.4	0	5	0	-1.4	0	15	-15	0	0	2
Input Bias Current	VF3	OFF	ON	OFF	5	0	-1.4	0	5	0	-1.4	0	15	-15	0	0	3
	VF4	ON	OFF														
Large Signal Voltage Gain	VF5	ON	ON	ON	15	0	-1.4	0	15	0	-1.4	0	15	-15	10	0	4
	VF6				15	0	-11.4	0	15	0	-11.4	0	15	-15	-10	0	
Common-mode Rejection Ratio (Input common-mode Voltage Range)	VF7	ON	ON	OFF	5	0	-1.4	0	5	0	-1.4	0	15	-15	0	-15	5
	VF8				5	0	-1.4	3.5	5	0	-1.4	3.5	15	-15	0	13	
Power Supply Rejection Ratio	VF9	ON	ON	OFF	5	0	-1.4	0	5	0	-1.4	0	2	-2	0	0	6
	VF10				30	0	-1.4	0	30	0	-1.4	0	15	-15	0	0	

-Calculation-

1. Input Offset Voltage (Vio)

$$V_{io} = \frac{|VF1|}{1 + R_f / R_s} \text{ [V]}$$

2. Input Offset Current (Iio)

$$I_{io} = \frac{|VF2 - VF1|}{R_i \times (1 + R_f / R_s)} \text{ [A]}$$

3. Input Bias Current (Ib)

$$I_b = \frac{|VF4 - VF3|}{2 \times R_i \times (1 + R_f / R_s)} \text{ [A]}$$

4. Large Signal Voltage Gain (Av)

$$A_v = 20 \times \text{Log} \frac{\Delta E_K \times (1 + R_f / R_s)}{|VF5 - VF6|} \text{ [dB]}$$

5. Common-mode Rejection Ration (CMRR)

$$CMRR = 20 \times \text{Log} \frac{\Delta V_{icm} \times (1 + R_f / R_s)}{|VF8 - VF7|} \text{ [dB]}$$

6. Power supply rejection ratio (PSRR)

$$PSRR = 20 \times \text{Log} \frac{\Delta V_{cc} \times (1 + R_f / R_s)}{|VF10 - VF9|} \text{ [dB]}$$

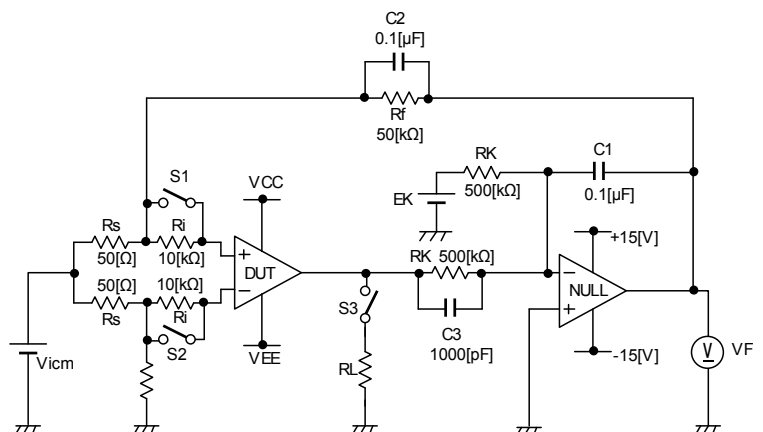

Fig. 120 Measurement circuit1 (one channel only)

● Measurement Circuit 2 Switch Condition

SW No.	SW 1	SW 2	SW 3	SW 4	SW 5	SW 6	SW 7	SW 8	SW 9	SW 10	SW 11	SW 12	SW 13	SW 14
Supply Current	OFF	OFF	OFF	ON	OFF	ON	OFF	OFF	OFF	OFF	OFF	OFF	OFF	OFF
High Level Output Voltage	OFF	OFF	ON	OFF	OFF	ON	OFF	OFF	ON	OFF	OFF	OFF	ON	OFF
Low Level Output Voltage	OFF	OFF	ON	OFF	OFF	ON	OFF	OFF	OFF	OFF	OFF	OFF	ON	OFF
Output Source Current	OFF	OFF	ON	OFF	OFF	ON	OFF	OFF	OFF	OFF	OFF	OFF	OFF	ON
Output Sink Current	OFF	OFF	ON	OFF	OFF	ON	OFF	OFF	OFF	OFF	OFF	OFF	OFF	ON
Slew Rate	OFF	OFF	OFF	ON	OFF	OFF	OFF	ON	ON	ON	OFF	OFF	OFF	OFF
Gain Bandwidth Product	OFF	ON	OFF	OFF	ON	ON	OFF	OFF	ON	ON	OFF	OFF	OFF	OFF
Equivalent Input Noise Voltage	ON	OFF	OFF	OFF	ON	ON	OFF	OFF	OFF	OFF	ON	OFF	OFF	OFF

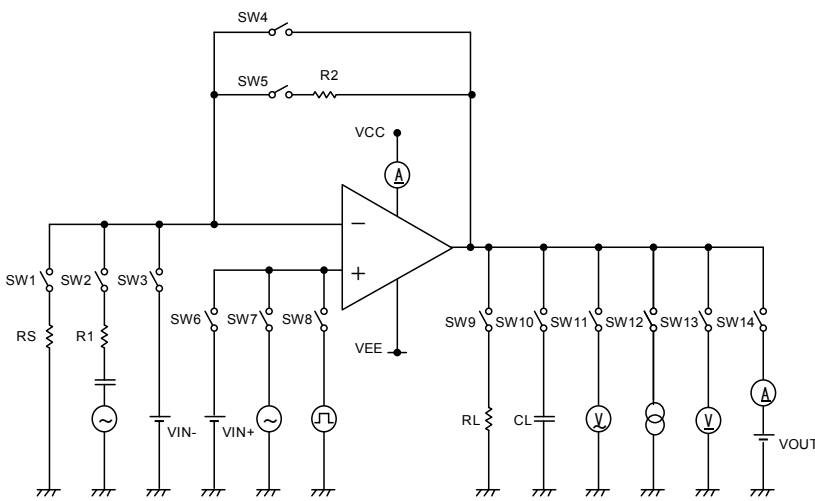

Fig. 121 Measurement Circuit 2 (each Op-Amp)

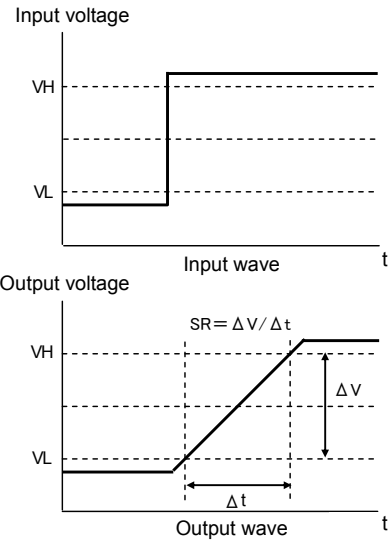

Fig. 122 Slew Rate Input Waveform

● Measurement Circuit 3 Amplifier To Amplifier Coupling

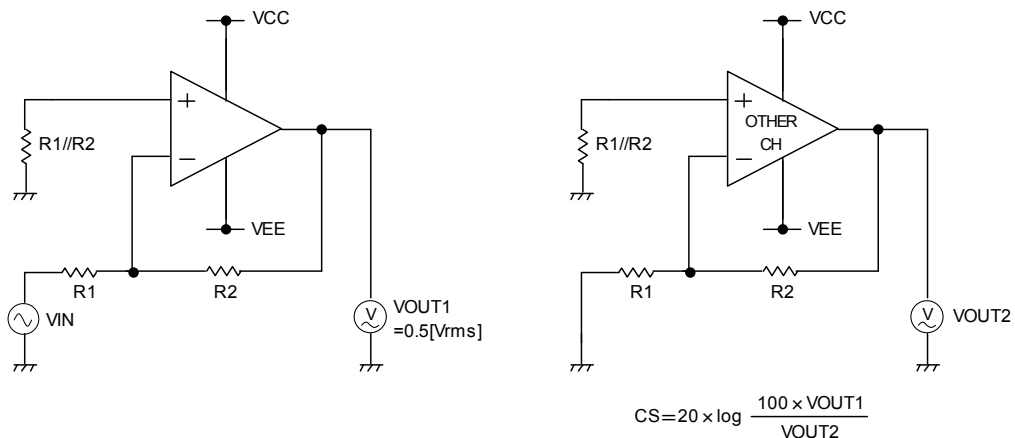

Fig. 123 Measurement Circuit 3

●Description of Electrical Characteristics

Described below are descriptions of the relevant electrical terms

Please note that item names, symbols and their meanings may differ from those on another manufacturer's documents.

1. Absolute maximum ratings

The absolute maximum ratings are values that should never be exceeded, since doing so may result in deterioration of electrical characteristics or damage to the part itself as well as peripheral components.

1.1 Power supply voltage (VCC-VEE)

Expresses the maximum voltage that can be supplied between the positive and negative supply terminals without causing deterioration of the electrical characteristics or destruction of the internal circuitry.

1.2 Differential input voltage (V_{id})

Indicates the maximum voltage that can be supplied between the non-inverting and inverting terminals without damaging the IC.

1.3 Input common-mode voltage range (V_{icm})

Signifies the maximum voltage that can be supplied to non-inverting and inverting terminals without causing deterioration of the characteristics or damage to the IC itself. Normal operation is not guaranteed within the common-mode voltage range of the maximum ratings – use within the input common-mode voltage range of the electric characteristics instead.

1.4 Operating and storage temperature ranges (T_{opr}, T_{stg})

The operating temperature range indicates the temperature range within which the IC can operate. The higher the ambient temperature, the lower the power consumption of the IC. The storage temperature range denotes the range of temperatures the IC can be stored under without causing excessive deterioration of the electrical characteristics.

1.5 Power dissipation (P_d)

Indicates the power that can be consumed by a particular mounted board at ambient temperature (25°C). For packaged products, P_d is determined by the maximum junction temperature and the thermal resistance.

2. Electrical characteristics

2.1 Input offset voltage (V_{io})

Signifies the voltage difference between the non-inverting and inverting terminals. It can be thought of as the input voltage difference required for setting the output voltage to 0 V.

2.2 Input offset voltage drift ($\Delta V_{io}/\Delta T$)

Denotes the ratio of the input offset voltage fluctuation to the ambient temperature fluctuation.

2.3 Input offset current (I_{io})

Indicates the difference of input bias current between the non-inverting and inverting terminals.

2.4 Input offset current drift ($\Delta I_{io}/\Delta T$)

Signifies the ratio of the input offset current fluctuation to the ambient temperature fluctuation.

2.5 Input bias current (I_b)

Denotes the current that flows into or out of the input terminal, it is defined by the average of the input bias current at the non-inverting terminal and the input bias current at the inverting terminal.

2.6 Circuit current (I_{CC})

Indicates the current of the IC itself that flows under specified conditions and during no-load steady state.

2.7 High level output voltage/low level output voltage (V_{OH}/V_{OL})

Signifying the voltage range that can be output under specified load conditions, it is in general divided into high level output voltage and low level output voltage. High level output voltage indicates the upper limit of the output voltage, while low level output voltage the lower limit.

2.8 Large signal voltage gain (A_V)

The amplifying rate (gain) of the output voltage against the voltage difference between non-inverting and inverting terminals, it is (normally) the amplifying rate (gain) with respect to DC voltage.

$A_V = (\text{output voltage fluctuation}) / (\text{input offset fluctuation})$

2.9 Input common-mode voltage range (V_{icm})

Indicates the input voltage range under which the IC operates normally.

2.10 Common-mode rejection ratio (CMRR)

Signifies the ratio of fluctuation of the input offset voltage when the in-phase input voltage is changed (DC fluctuation).

$CMRR = (\text{change in input common-mode voltage}) / (\text{input offset fluctuation})$

2.11 Power supply rejection ratio (PSRR)

Denotes the ratio of fluctuation of the input offset voltage when supply voltage is changed (DC fluctuation).

$SVR = (\text{change in power supply voltage}) / (\text{input offset fluctuation})$

2.12 Output source current/ output sink current (IOH/IOL)

The maximum current that can be output under specific output conditions, it is divided into output source current and output sink current. The output source current indicates the current flowing out of the IC, and the output sink current the current flowing into the IC.

2.13 Channel separation (CS)

Expresses the amount of fluctuation of the input offset voltage or output voltage with respect to the change in the output voltage of a driven channel.

2.14 Slew rate (SR)

Indicates the time fluctuation ratio of the output voltage when an input step signal is supplied.

2.15 Gain bandwidth product (GBW)

The product of the specified signal frequency and the gain of the op-amp at such frequency, it gives the approximate value of the frequency where the gain of the op-amp is 1 (maximum frequency, and unity gain frequency).

●Derating curves

Power dissipation(total loss) indicates the power that can be consumed by IC at Ta=25°C(normal temperature). IC is heated when it consumed power, and the temperature of IC chip becomes higher than ambient temperature. The temperature that can be accepted by IC chip depends on circuit configuration, manufacturing process, and consumable power is limited. Power dissipation is determined by the temperature allowed in IC chip(maximum junction temperature) and thermal resistance of package(heat dissipation capability). The maximum junction temperature is typically equal to the maximum value in the storage temperature range. Heat generated by consumed power of IC radiates from the mold resin or lead frame of the package. The parameter which indicates this heat dissipation capability(hardness of heat release)is called thermal resistance, represented by the symbol θ_{ja} [°C/W].The temperature of IC inside the package can be estimated by this thermal resistance. Fig.124(a) shows the model of thermal resistance of the package. Thermal resistance θ_{ja} , ambient temperature Ta, junction temperature Tj, and power dissipation Pd can be calculated by the equation below:

$$\theta_{ja} = (T_j - T_a) / P_d \quad [^{\circ}\text{C}/\text{W}] \quad \dots \dots (I)$$

Derating curve in Fig.124(b) indicates power that can be consumed by IC with reference to ambient temperature. Power that can be consumed by IC begins to attenuate at certain ambient temperature. This gradient is determined by thermal resistance θ_{ja} . Thermal resistance θ_{ja} depends on chip size, power consumption, package, ambient temperature, package condition, wind velocity, etc even when the same of package is used.

Thermal reduction curve indicates a reference value measured at a specified condition. Fig.125(a)~(d) show a derating curve for an example of BA10358, BA10324A, BA2904S, BA2904, BA2904HFVM-C, BA3404, BA2902S, BA2902.

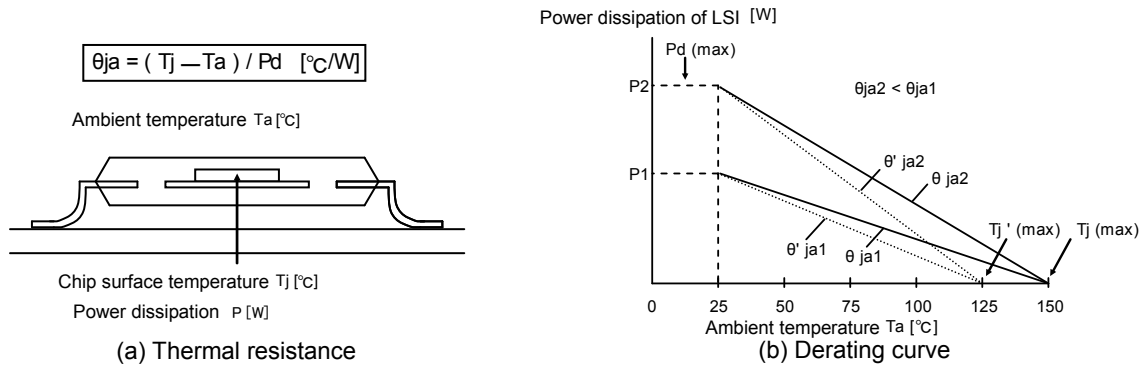
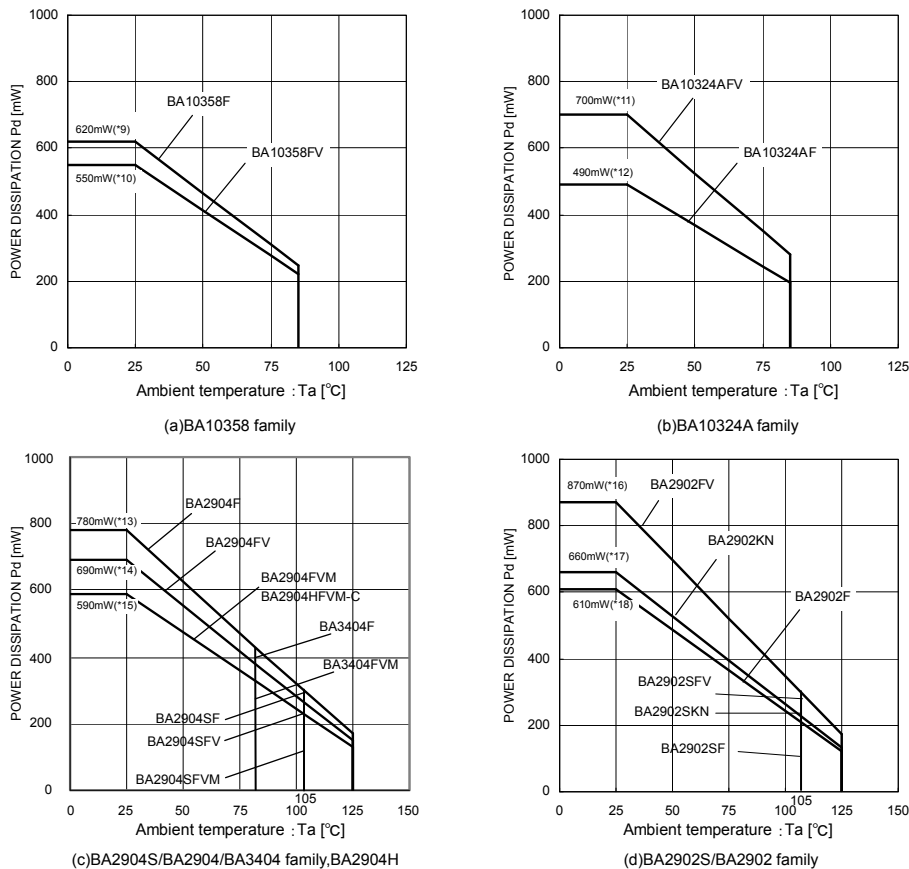

Fig. 124 Thermal resistance and derating curve



(*9)	(*10)	(*11)	(*12)	(*13)	(*14)	(*15)	(*16)	(*17)	(*18)	Unit
6.2	5.5	7.0	4.9	6.2	5.5	4.8	7.0	5.3	4.9	[mW/°C]

When using the unit above Ta=25°C], subtract the value above per degree°C].
Permissible dissipation is the value when FR4 glass epoxy board 70[mm]×70[mm]×1.6[mm](cooper foil area below 3[%]) is mounted.

Fig. 125 Derating curve

●Precautions

1) Unused circuits

When there are unused circuits, it is recommended that they be connected as in Fig.126, setting the non-inverting input terminal to a potential within the in-phase input voltage range (Vicm).

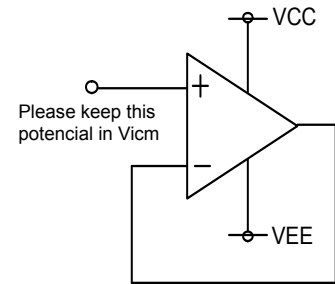

Fig. 126 Example of processing unused

2) Input voltage

Applying $VEE+32[V]$ (BA2904S/BA2904/BA2902S/BA2902 family, BA2904HFVM-C) and $VEE+36[V]$ (BA3404 family) to the input terminal is possible without causing deterioration of the electrical characteristics or destruction, irrespective of the supply voltage. However, this does not ensure normal circuit operation. Please note that the circuit operates normally only when the input voltage is within the common mode input voltage range of the electric characteristics.

3) Power supply (single / dual)

The op-amp operates when the voltage supplied is between VCC and VEE. Therefore, the single supply op-mp can be used as a dual supply op-amp as well.

4) Power dissipation (Pd)

Using the unit in excess of the rated power dissipation may cause deterioration in electrical characteristics due to the rise in chip temperature, including reduced current capability. Therefore, please take into consideration the power dissipation (Pd) under actual operating conditions and apply a sufficient margin in thermal design. Refer to the thermal derating curves for more information.

5) Short-circuit between pins and erroneous mounting

Incorrect mounting may damage the IC. In addition, the presence of foreign substances between the outputs, the output and the power supply, or the output and GND may result in IC destruction.

6) Operation in a strong electromagnetic field

Operation in a strong electromagnetic field may cause malfunctions.

7) Radiation

This IC is not designed to withstand radiation.

8) IC handling

Applying mechanical stress to the IC by deflecting or bending the board may cause fluctuation of the electrical characteristics due to piezoelectric (piezo) effects.

9) IC operation

The output stage of the IC is configured using Class C push-pull circuits. Therefore, when the load resistor is connected to the middle potential of VCC and VEE, crossover distortion occurs at the changeover between discharging and charging of the output current. Connecting a resistor between the output terminal and GND, and increasing the bias current for Class A operation will suppress crossover distortion.

10) Board inspection

Connecting a capacitor to a pin with low impedance may stress the IC. Therefore, discharging the capacitor after every process is recommended. In addition, when attaching and detaching the jig during the inspection phase, ensure that the power is turned OFF before inspection and removal. Furthermore, please take measures against ESD in the assembly process as well as during transportation and storage.

11) Output capacitor

Discharge of the external output capacitor to VCC is possible via internal parasitic elements when VCC is shorted to VEE, causing damage to the internal circuitry due to thermal stress. Therefore, when using this IC in circuits where oscillation due to output capacitive load does not occur, such as in voltage comparators, use an output capacitor with a capacitance less than 0.1 μ F.

● Ordering part number

B	A	2	9	0	4	F	V	-	E	2	
Part No.		Part No. 10358, 10324A 2904S, 2904 2904H, 3404 B902S, 2902				Package F: SOP8 SOP14 FV: SSOP-B8 SSOP-B14 FVM: MSOP8 KN: VQFN16		Packaging and forming specification E2: Embossed tape and reel (SOP8/SOP14/SSOP-B8/SSOP-B14/VQFN16) TR: Embossed tape and reel (MSOP8)			

SOP8

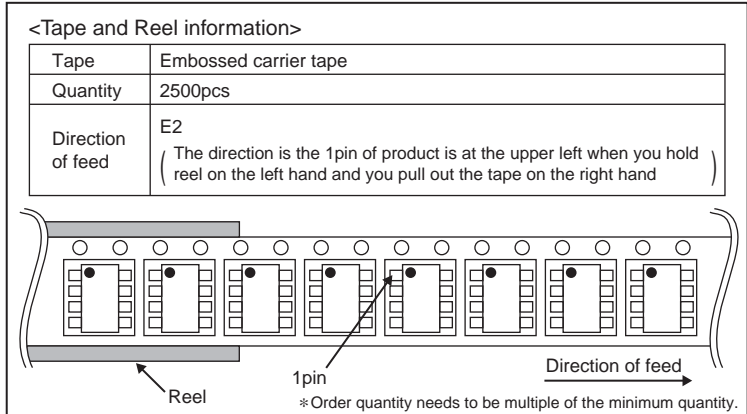
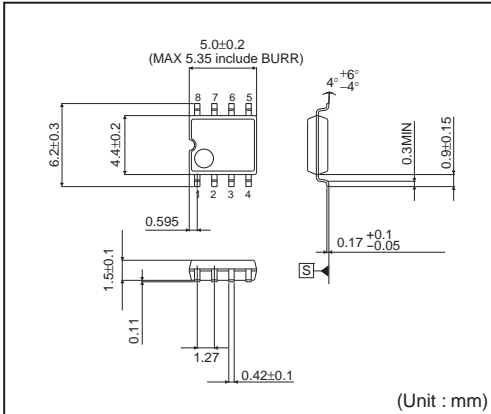

SOP14

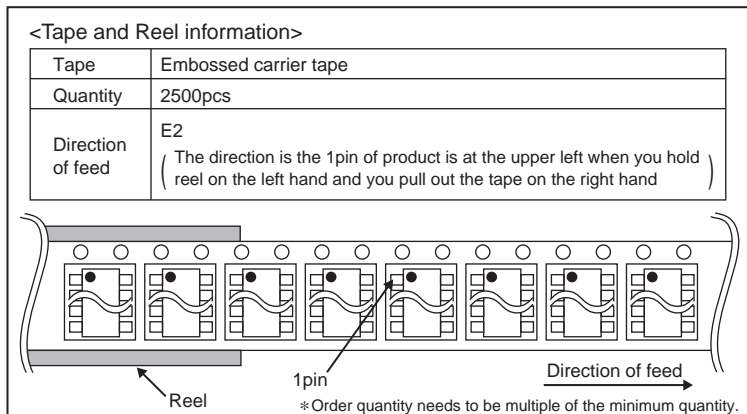
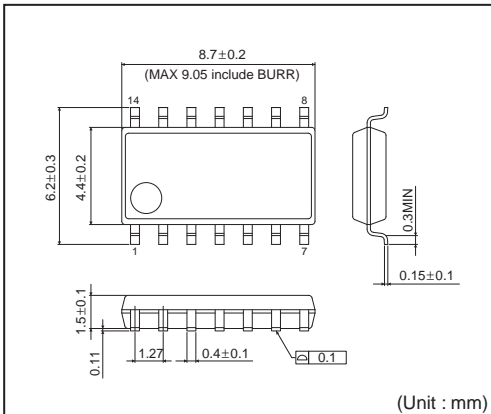

SSOP-B8

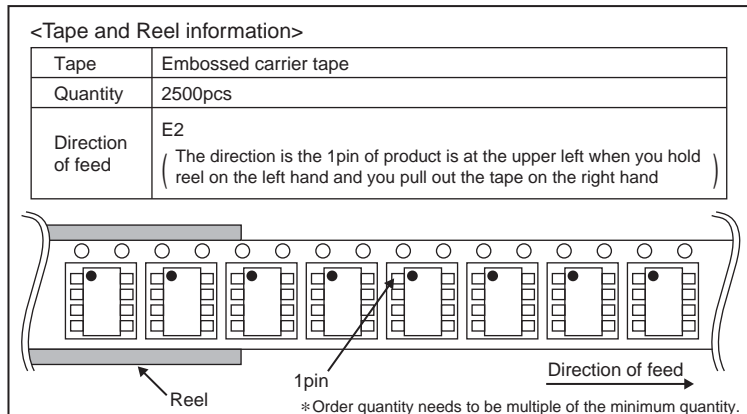
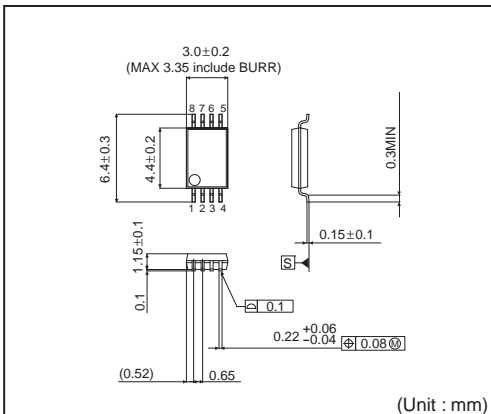

SSOP-B14

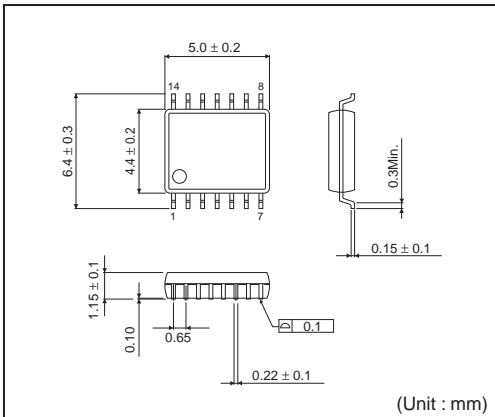

<Tape and Reel information>

Tape	Embossed carrier tape
Quantity	2500pcs
Direction of feed	E2 (The direction is the 1pin of product is at the upper left when you hold reel on the left hand and you pull out the tape on the right hand)

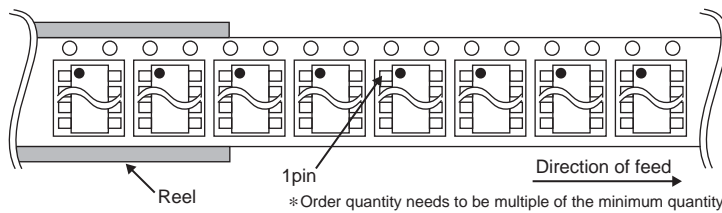

MSOP8

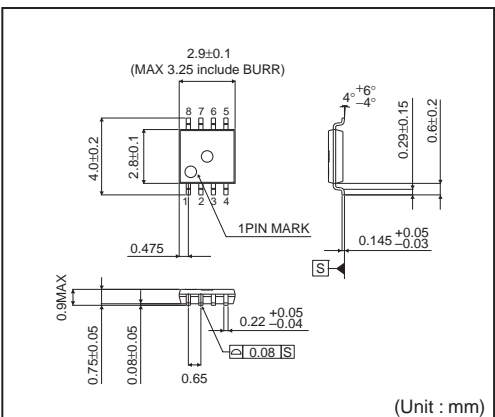

<Tape and Reel information>

Tape	Embossed carrier tape
Quantity	3000pcs
Direction of feed	TR (The direction is the 1pin of product is at the upper right when you hold reel on the left hand and you pull out the tape on the right hand)

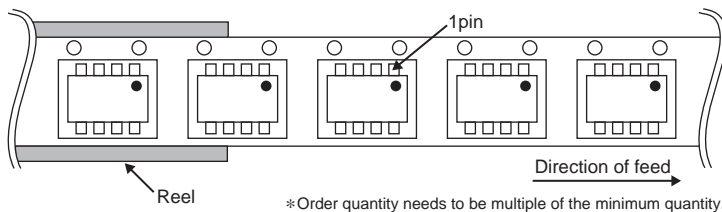

VQFN16

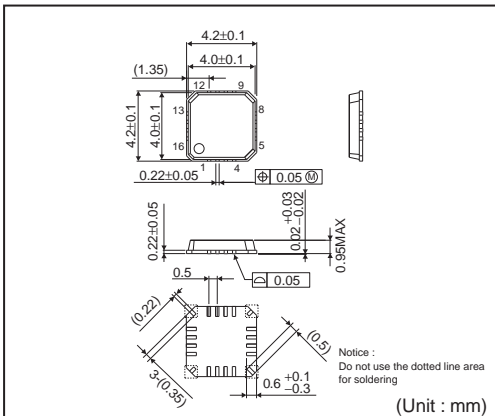

<Tape and Reel information>

Tape	Embossed carrier tape (with dry pack)
Quantity	2500pcs
Direction of feed	E2 (The direction is the 1pin of product is at the upper left when you hold reel on the left hand and you pull out the tape on the right hand)

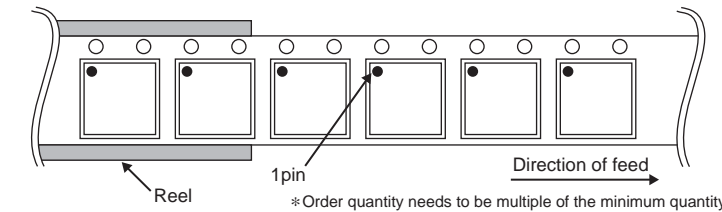

Notes

No copying or reproduction of this document, in part or in whole, is permitted without the consent of ROHM Co.,Ltd.

The content specified herein is subject to change for improvement without notice.

The content specified herein is for the purpose of introducing ROHM's products (hereinafter "Products"). If you wish to use any such Product, please be sure to refer to the specifications, which can be obtained from ROHM upon request.

Examples of application circuits, circuit constants and any other information contained herein illustrate the standard usage and operations of the Products. The peripheral conditions must be taken into account when designing circuits for mass production.

Great care was taken in ensuring the accuracy of the information specified in this document. However, should you incur any damage arising from any inaccuracy or misprint of such information, ROHM shall bear no responsibility for such damage.

The technical information specified herein is intended only to show the typical functions of and examples of application circuits for the Products. ROHM does not grant you, explicitly or implicitly, any license to use or exercise intellectual property or other rights held by ROHM and other parties. ROHM shall bear no responsibility whatsoever for any dispute arising from the use of such technical information.

The Products specified in this document are intended to be used with general-use electronic equipment or devices (such as audio visual equipment, office-automation equipment, communication devices, electronic appliances and amusement devices).

The Products specified in this document are not designed to be radiation tolerant.

While ROHM always makes efforts to enhance the quality and reliability of its Products, a Product may fail or malfunction for a variety of reasons.

Please be sure to implement in your equipment using the Products safety measures to guard against the possibility of physical injury, fire or any other damage caused in the event of the failure of any Product, such as derating, redundancy, fire control and fail-safe designs. ROHM shall bear no responsibility whatsoever for your use of any Product outside of the prescribed scope or not in accordance with the instruction manual.

The Products are not designed or manufactured to be used with any equipment, device or system which requires an extremely high level of reliability the failure or malfunction of which may result in a direct threat to human life or create a risk of human injury (such as a medical instrument, transportation equipment, aerospace machinery, nuclear-reactor controller, fuel-controller or other safety device). ROHM shall bear no responsibility in any way for use of any of the Products for the above special purposes. If a Product is intended to be used for any such special purpose, please contact a ROHM sales representative before purchasing.

If you intend to export or ship overseas any Product or technology specified herein that may be controlled under the Foreign Exchange and the Foreign Trade Law, you will be required to obtain a license or permit under the Law.



Thank you for your accessing to ROHM product informations.
More detail product informations and catalogs are available, please contact us.

ROHM Customer Support System

<http://www.rohm.com/contact/>