

1SMB5913BT3 Series

Preferred Device

3 Watt Plastic Surface Mount Zener Voltage Regulators

This complete new line of 3 Watt Zener diodes offers the following advantages.

Features

- Zener Voltage Range – 3.3 V to 200 V
- ESD Rating of Class 3 (>16 kV) per Human Body Model
- Flat Handling Surface for Accurate Placement
- Package Design for Top Side or Bottom Circuit Board Mounting
- Pb-Free Packages are Available

Mechanical Characteristics:

CASE: Void-free, transfer-molded plastic

FINISH: All external surfaces are corrosion resistant and leads are readily solderable

MAXIMUM LEAD TEMPERATURE FOR SOLDERING PURPOSES:
260°C for 10 Seconds

LEADS: Modified L-Bend providing more contact area to bond pads

POLARITY: Cathode indicated by polarity band

FLAMMABILITY RATING: UL 94 V-0

MAXIMUM RATINGS

| Rating | Symbol | Value | Unit |
|--|-----------------|-------------|----------------------------|
| Maximum Steady State Power Dissipation @ $T_L = 75^\circ\text{C}$ Measured at Zero Lead Length Derate Above 75°C | P_D | 3.0 | W |
| Thermal Resistance from Junction-to-Lead | $R_{\theta JL}$ | 40 | $\text{mW}/^\circ\text{C}$ |
| | | 25 | $^\circ\text{C}/\text{W}$ |
| Maximum Steady State Power Dissipation @ $T_A = 25^\circ\text{C}$ (Note) Derate Above 25°C | P_D | 550 | mW |
| Thermal Resistance from Junction-to-Ambient | $R_{\theta JA}$ | 4.4 | $\text{mW}/^\circ\text{C}$ |
| | | 226 | $^\circ\text{C}/\text{W}$ |
| Operating and Storage Temperature Range | T_J, T_{stg} | -65 to +150 | $^\circ\text{C}$ |

Stresses exceeding Maximum Ratings may damage the device. Maximum Ratings are stress ratings only. Functional operation above the Recommended Operating Conditions is not implied. Extended exposure to stresses above the Recommended Operating Conditions may affect device reliability.

1. FR-4 board, using recommended footprint.



ON Semiconductor®

<http://onsemi.com>

PLASTIC SURFACE MOUNT
ZENER VOLTAGE
REGULATOR DIODES
3.3–200 V, 3 W DC POWER

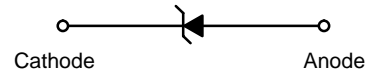

SMB
CASE 403A
PLASTIC

MARKING DIAGRAM



A = Assembly Location
Y = Year
WW = Work Week
9xxB = Device Code (Refer to page 3)
▪ = Pb-Free Package
(Note: Microdot may be in either location)

ORDERING INFORMATION

| Device | Package | Shipping† |
|--------------|------------------|------------------|
| 1SMB59xxBT3 | SMB | 2500/Tape & Reel |
| 1SMB59xxBT3G | SMB (Pb-Free) | 2500/Tape & Reel |

†For information on tape and reel specifications, including part orientation and tape sizes, please refer to our Tape and Reel Packaging Specifications Brochure, BRD8011/D.

DEVICE MARKING INFORMATION

See specific marking information in the device marking column of the Electrical Characteristics table on page 3 of this data sheet.

Preferred devices are recommended choices for future use and best overall value.

1SMB5913BT3 Series

ELECTRICAL CHARACTERISTICS

($T_L = 30^\circ\text{C}$ unless otherwise noted,
 $V_F = 1.5\text{ V Max.}$ @ $I_F = 200\text{ mA(dc)}$ for all types)

| Symbol | Parameter |
|----------|------------------------------------|
| V_Z | Reverse Zener Voltage @ I_{ZT} |
| I_{ZT} | Reverse Current |
| Z_{ZT} | Maximum Zener Impedance @ I_{ZT} |
| I_{ZK} | Reverse Current |
| Z_{ZK} | Maximum Zener Impedance @ I_{ZK} |
| I_R | Reverse Leakage Current @ V_R |
| V_R | Reverse Voltage |
| I_F | Forward Current |
| V_F | Forward Voltage @ I_F |
| I_{ZM} | Maximum DC Zener Current |

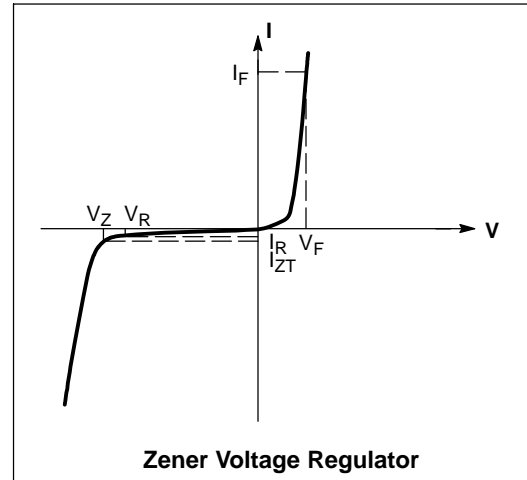

1SMB5913BT3 Series

ELECTRICAL CHARACTERISTICS (Devices listed in **bold, italic** are ON Semiconductor Preferred devices.)

($T_L = 30^\circ\text{C}$ unless otherwise noted, $V_F = 1.5\text{ V Max.}$ @ $I_F = 200\text{ mA(dc)}$ for all types)

| Device* (Note 2) | Device Marking | Zener Voltage (Note 3) | | | | Zener Impedance (Note 4) | | | Leakage Current | | I_{ZM} mA(dc) |
|-----------------------|-------------------|------------------------|------------|--------------|-------------|--------------------------|---------------------|-------------|-----------------|-------------|--------------------|
| | | V_Z (Volts) | | | @ I_{ZT} | Z_{ZT} @ I_{ZT} | Z_{ZK} @ I_{ZK} | | I_R @ V_R | | |
| | | Min | Nom | Max | mA | Ω | Ω | mA | μA | Volts | |
| 1SMB5913BT3, G | 913B | 3.13 | 3.3 | 3.47 | 113.6 | 10 | 500 | 1 | 100 | 1 | 454 |
| 1SMB5914BT3, G | 914B | 3.42 | 3.6 | 3.78 | 104.2 | 9 | 500 | 1 | 75 | 1 | 416 |
| 1SMB5915BT3, G | 915B | 3.70 | 3.9 | 4.10 | 96.1 | 7.5 | 500 | 1 | 25 | 1 | 384 |
| 1SMB5916BT3, G | 916B | 4.08 | 4.3 | 4.52 | 87.2 | 6 | 500 | 1 | 5 | 1 | 348 |
| 1SMB5917BT3, G | 917B | 4.46 | 4.7 | 4.94 | 79.8 | 5 | 500 | 1 | 5 | 1.5 | 319 |
| 1SMB5918BT3, G | 918B | 4.84 | 5.1 | 5.36 | 73.5 | 4 | 350 | 1 | 5 | 2 | 294 |
| 1SMB5919BT3, G | 919B | 5.32 | 5.6 | 5.88 | 66.9 | 2 | 250 | 1 | 5 | 3 | 267 |
| 1SMB5920BT3, G | 920B | 5.89 | 6.2 | 6.51 | 60.5 | 2 | 200 | 1 | 5 | 4 | 241 |
| 1SMB5921BT3, G | 921B | 6.46 | 6.8 | 7.14 | 55.1 | 2.5 | 200 | 1 | 5 | 5.2 | 220 |
| 1SMB5922BT3, G | 922B | 7.12 | 7.5 | 7.88 | 50 | 3 | 400 | 0.5 | 5 | 6 | 200 |
| 1SMB5923BT3, G | 923B | 7.79 | 8.2 | 8.61 | 45.7 | 3.5 | 400 | 0.5 | 5 | 6.5 | 182 |
| 1SMB5924BT3, G | 924B | 8.64 | 9.1 | 9.56 | 41.2 | 4 | 500 | 0.5 | 5 | 7 | 164 |
| 1SMB5925BT3, G | 925B | 9.5 | 10 | 10.5 | 37.5 | 4.5 | 500 | 0.25 | 5 | 8 | 150 |
| 1SMB5926BT3, G | 926B | 10.45 | 11 | 11.55 | 34.1 | 5.5 | 550 | 0.25 | 1 | 8.4 | 136 |
| 1SMB5927BT3, G | 927B | 11.4 | 12 | 12.6 | 31.2 | 6.5 | 550 | 0.25 | 1 | 9.1 | 125 |
| 1SMB5928BT3, G | 928B | 12.35 | 13 | 13.65 | 28.8 | 7 | 550 | 0.25 | 1 | 9.9 | 115 |
| 1SMB5929BT3, G | 929B | 14.25 | 15 | 15.75 | 25 | 9 | 600 | 0.25 | 1 | 11.4 | 100 |
| 1SMB5930BT3, G | 930B | 15.2 | 16 | 16.8 | 23.4 | 10 | 600 | 0.25 | 1 | 12.2 | 93 |
| 1SMB5931BT3, G | 931B | 17.1 | 18 | 18.9 | 20.8 | 12 | 650 | 0.25 | 1 | 13.7 | 83 |
| 1SMB5932BT3, G | 932B | 19 | 20 | 21 | 18.7 | 14 | 650 | 0.25 | 1 | 15.2 | 75 |
| 1SMB5933BT3, G | 933B | 20.9 | 22 | 23.1 | 17 | 17.5 | 650 | 0.25 | 1 | 16.7 | 68 |
| 1SMB5934BT3, G | 934B | 22.8 | 24 | 25.2 | 15.6 | 19 | 700 | 0.25 | 1 | 18.2 | 62 |
| 1SMB5935BT3, G | 935B | 25.65 | 27 | 28.35 | 13.9 | 23 | 700 | 0.25 | 1 | 20.6 | 55 |
| 1SMB5936BT3, G | 936B | 28.5 | 30 | 31.5 | 12.5 | 28 | 750 | 0.25 | 1 | 22.8 | 50 |
| 1SMB5937BT3, G | 937B | 31.35 | 33 | 34.65 | 11.4 | 33 | 800 | 0.25 | 1 | 25.1 | 45 |
| 1SMB5938BT3, G | 938B | 34.2 | 36 | 37.8 | 10.4 | 38 | 850 | 0.25 | 1 | 27.4 | 41 |
| 1SMB5939BT3, G | 939B | 37.05 | 39 | 40.95 | 9.6 | 45 | 900 | 0.25 | 1 | 29.7 | 38 |
| 1SMB5940BT3, G | 940B | 40.85 | 43 | 45.15 | 8.7 | 53 | 950 | 0.25 | 1 | 32.7 | 34 |
| 1SMB5941BT3, G | 941B | 44.65 | 47 | 49.35 | 8 | 67 | 1000 | 0.25 | 1 | 35.8 | 31 |
| 1SMB5942BT3, G | 942B | 48.45 | 51 | 53.55 | 7.3 | 70 | 1100 | 0.25 | 1 | 38.8 | 29 |
| 1SMB5943BT3, G | 943B | 53.2 | 56 | 58.8 | 6.7 | 86 | 1300 | 0.25 | 1 | 42.6 | 26 |
| 1SMB5944BT3, G | 944B | 58.9 | 62 | 65.1 | 6 | 100 | 1500 | 0.25 | 1 | 47.1 | 24 |
| 1SMB5945BT3, G | 945B | 64.6 | 68 | 71.4 | 5.5 | 120 | 1700 | 0.25 | 1 | 51.7 | 22 |
| 1SMB5946BT3, G | 946B | 71.25 | 75 | 78.75 | 5 | 140 | 2000 | 0.25 | 1 | 56 | 20 |
| 1SMB5947BT3, G | 947B | 77.9 | 82 | 86.1 | 4.6 | 160 | 2500 | 0.25 | 1 | 62.2 | 18 |
| 1SMB5948BT3, G | 948B | 86.45 | 91 | 95.55 | 4.1 | 200 | 3000 | 0.25 | 1 | 69.2 | 16 |
| 1SMB5949BT3, G | 949B | 95 | 100 | 105 | 3.7 | 250 | 3100 | 0.25 | 1 | 76 | 15 |
| 1SMB5950BT3, G | 950B | 104.5 | 110 | 115.5 | 3.4 | 300 | 4000 | 0.25 | 1 | 83.6 | 13 |
| 1SMB5951BT3, G | 951B | 114 | 120 | 126 | 3.1 | 380 | 4500 | 0.25 | 1 | 91.2 | 12 |
| 1SMB5952BT3, G | 952B | 123.5 | 130 | 136.5 | 2.9 | 450 | 5000 | 0.25 | 1 | 98.8 | 11 |
| 1SMB5953BT3, G | 953B | 142.5 | 150 | 157.5 | 2.5 | 600 | 6000 | 0.25 | 1 | 114 | 10 |
| 1SMB5954BT3, G | 954B | 152 | 160 | 168 | 2.3 | 700 | 6500 | 0.25 | 1 | 121.6 | 9 |
| 1SMB5955BT3, G | 955B | 171 | 180 | 189 | 2.1 | 900 | 7000 | 0.25 | 1 | 136.8 | 8 |
| 1SMB5956BT3, G | 956B | 190 | 200 | 210 | 1.9 | 1200 | 8000 | 0.25 | 1 | 152 | 7 |

2. **TOLERANCE AND TYPE NUMBER DESIGNATION** The type numbers listed indicate a tolerance of $\pm 5\%$.

3. **ZENER VOLTAGE (V_Z) MEASUREMENT**

Nominal Zener voltage is measured with the device junction in thermal equilibrium with ambient temperature at 25°C .

4. **ZENER IMPEDANCE (Z_Z) DERIVATION** Z_{ZT} and Z_{ZK} are measured by dividing the ac voltage drop across the device by the ac current applied. The specified limits are for $I_{Z(ac)} = 0.1 I_{Z(dc)}$ with the ac frequency = 60 Hz.

* The "G" suffix indicates Pb-Free package available.

1SMB5913BT3 Series

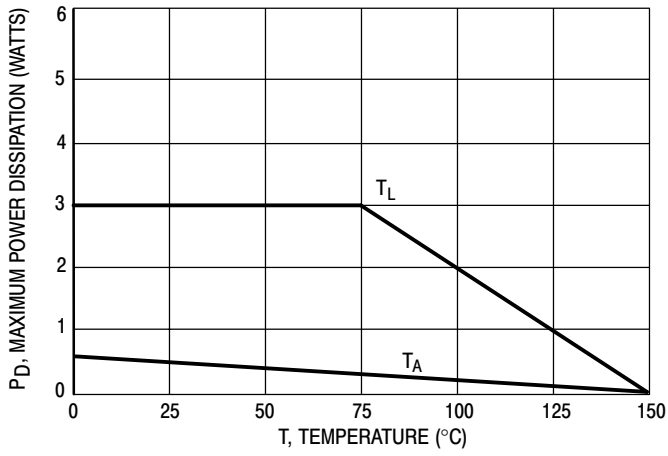

Figure 1. Steady State Power Derating

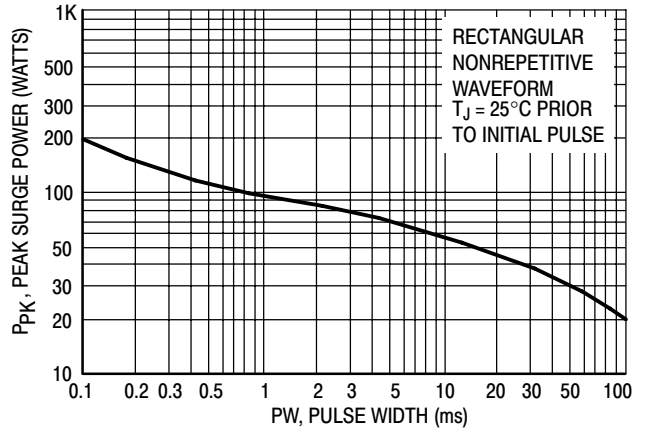

Figure 2. Maximum Surge Power

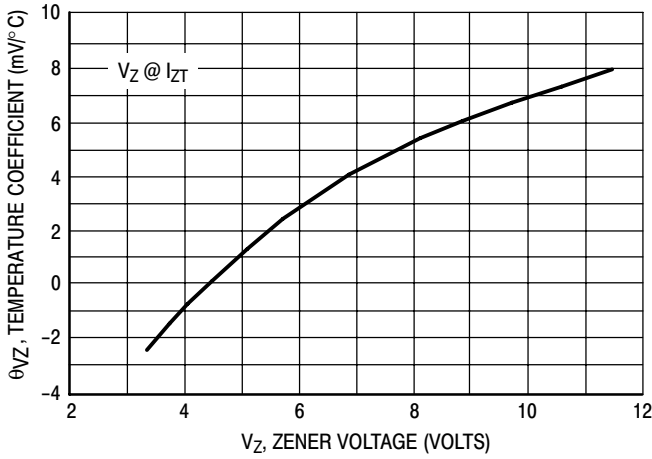

Figure 3. Zener Voltage - To 12 Volts

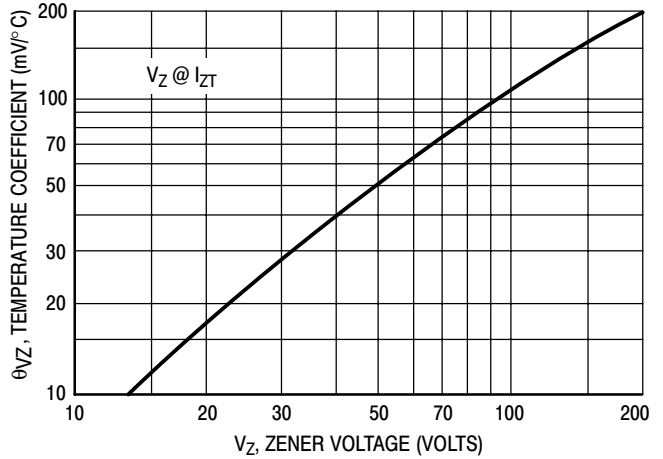

Figure 4. Zener Voltage - 14 To 200 Volts

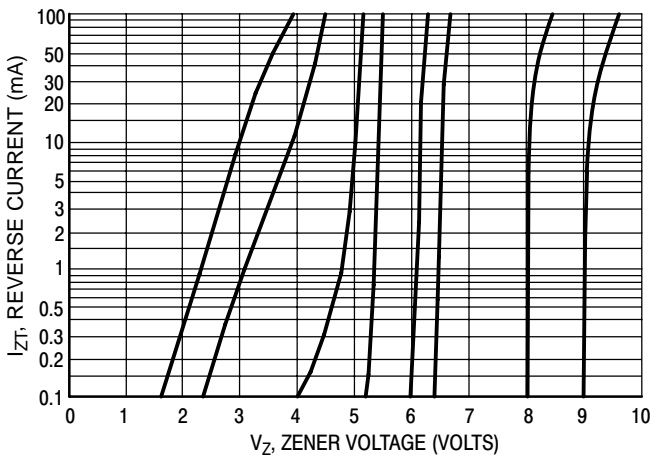

Figure 5. $V_Z = 3.3$ thru 10 Volts

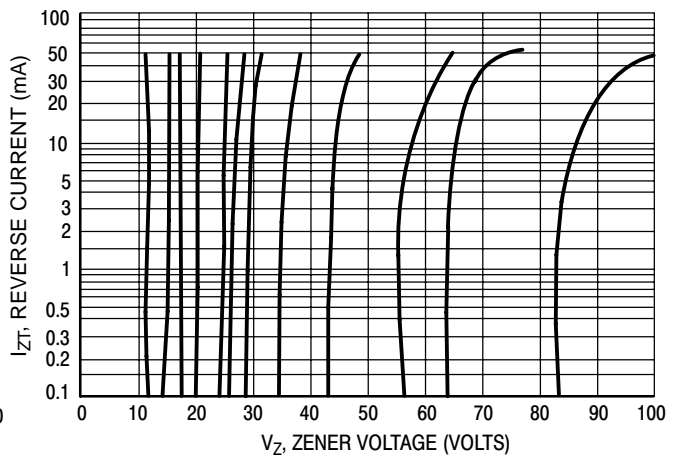

Figure 6. $V_Z = 12$ thru 82 Volts

1SMB5913BT3 Series

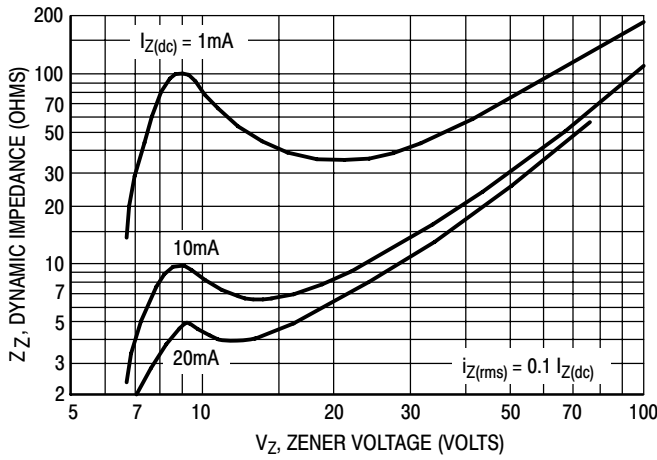

Figure 7. Effect of Zener Voltage

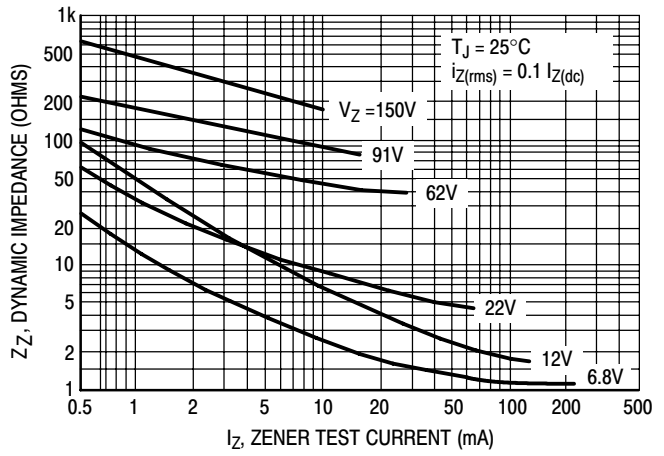

Figure 8. Effect of Zener Current

Rating and Typical Characteristic Curves ($T_A = 25^\circ\text{C}$)

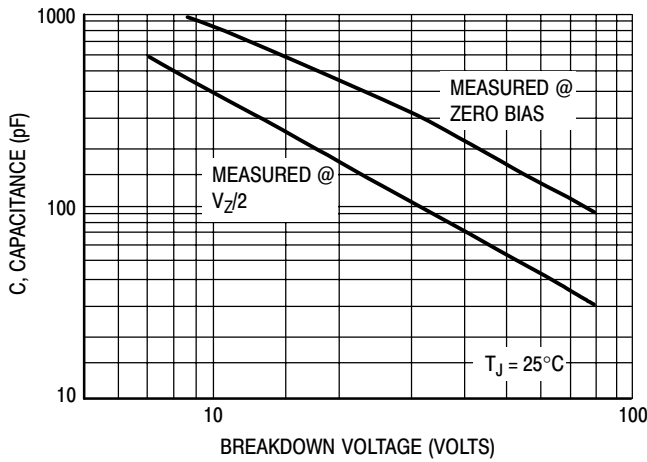

Figure 9. Capacitance Curve

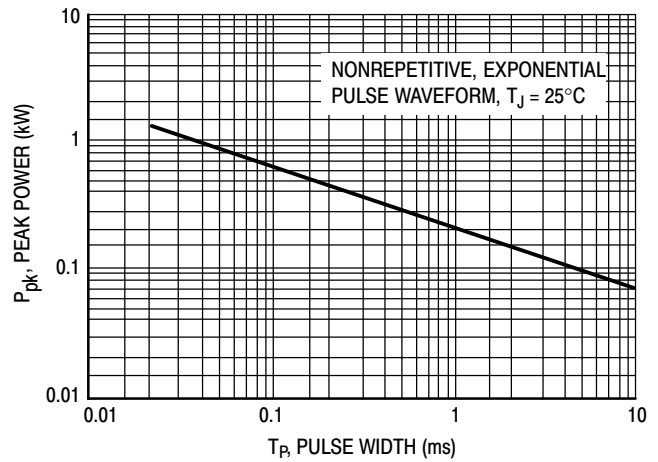

Figure 10. Typical Pulse Rating Curve

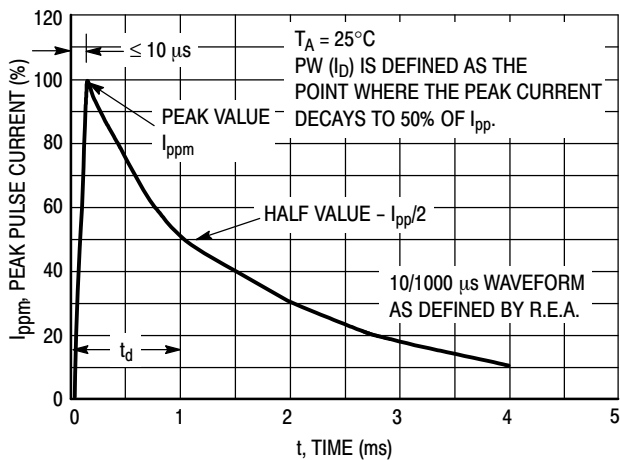

Figure 11. Pulse Waveform

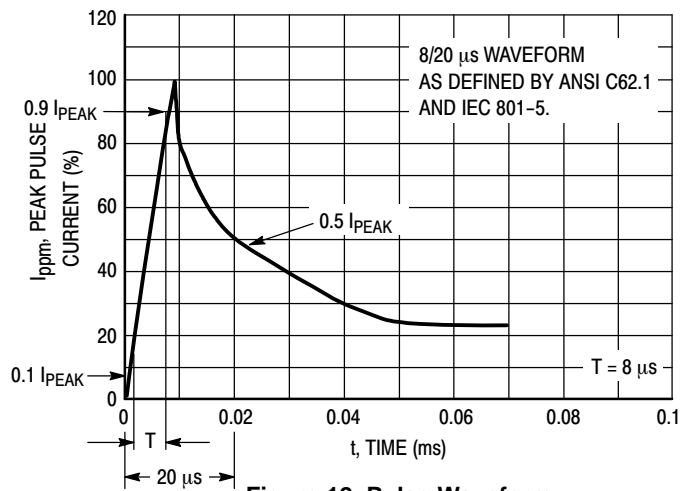
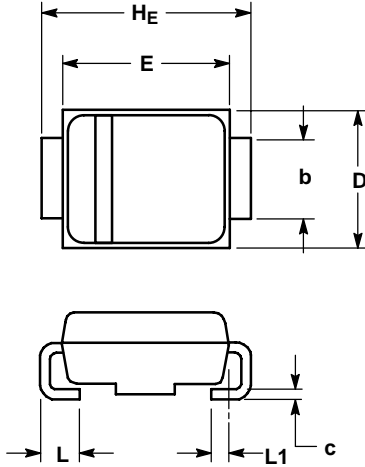

Figure 12. Pulse Waveform

1SMB5913BT3 Series

PACKAGE DIMENSIONS

SMB
CASE 403A-03
ISSUE E



- NOTES:
1. DIMENSIONING AND TOLERANCING PER ANSI Y14.5M, 1982.
2. CONTROLLING DIMENSION: INCH.
3. D DIMENSION SHALL BE MEASURED WITHIN DIMENSION P.

| DIM | MILLIMETERS | | | INCHES | | |
|-----|-------------|------|------|-----------|-------|-------|
| | MIN | NOM | MAX | MIN | NOM | MAX |
| A | 1.90 | 2.13 | 2.41 | 0.075 | 0.084 | 0.095 |
| A1 | 0.05 | 0.10 | 0.15 | 0.002 | 0.004 | 0.006 |
| b | 1.96 | 2.03 | 2.11 | 0.077 | 0.080 | 0.083 |
| c | 0.15 | 0.23 | 0.30 | 0.006 | 0.009 | 0.012 |
| D | 3.30 | 3.56 | 3.81 | 0.130 | 0.140 | 0.150 |
| E | 4.06 | 4.32 | 4.57 | 0.160 | 0.170 | 0.180 |
| HE | 5.21 | 5.44 | 5.59 | 0.205 | 0.214 | 0.220 |
| L | 0.76 | 1.02 | 1.27 | 0.030 | 0.040 | 0.050 |
| L1 | 0.51 REF | | | 0.020 REF | | |

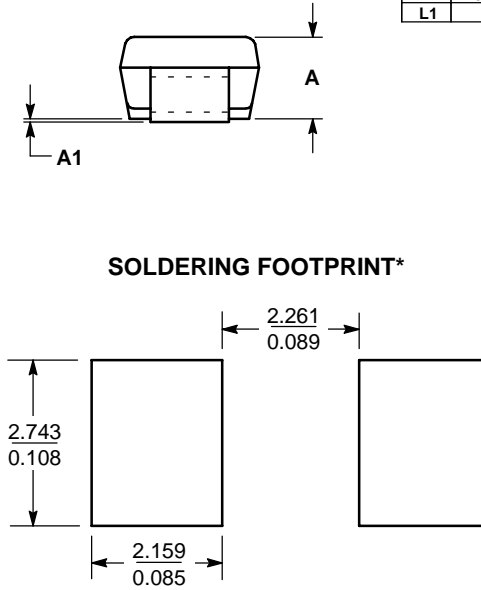

SCALE 8:1 $\left(\frac{\text{mm}}{\text{inches}}\right)$

*For additional information on our Pb-Free strategy and soldering details, please download the ON Semiconductor Soldering and Mounting Techniques Reference Manual, SOLDERRM/D.

ON Semiconductor and are registered trademarks of Semiconductor Components Industries, LLC (SCILLC). SCILLC reserves the right to make changes without further notice to any products herein. SCILLC makes no warranty, representation or guarantee regarding the suitability of its products for any particular purpose, nor does SCILLC assume any liability arising out of the application or use of any product or circuit, and specifically disclaims any and all liability, including without limitation special, consequential or incidental damages. "Typical" parameters which may be provided in SCILLC data sheets and/or specifications can and do vary in different applications and actual performance may vary over time. All operating parameters, including "Typicals" must be validated for each customer application by customer's technical experts. SCILLC does not convey any license under its patent rights nor the rights of others. SCILLC products are not designed, intended, or authorized for use as components in systems intended for surgical implant into the body, or other applications intended to support or sustain life, or for any other application in which the failure of the SCILLC product could create a situation where personal injury or death may occur. Should Buyer purchase or use SCILLC products for any such unintended or unauthorized application, Buyer shall indemnify and hold SCILLC and its officers, employees, subsidiaries, affiliates, and distributors harmless against all claims, costs, damages, and expenses, and reasonable attorney fees arising out of, directly or indirectly, any claim of personal injury or death associated with such unintended or unauthorized use, even if such claim alleges that SCILLC was negligent regarding the design or manufacture of the part. SCILLC is an Equal Opportunity/Affirmative Action Employer. This literature is subject to all applicable copyright laws and is not for resale in any manner.

PUBLICATION ORDERING INFORMATION

LITERATURE FULFILLMENT:
Literature Distribution Center for ON Semiconductor
P.O. Box 5163, Denver, Colorado 80217 USA
Phone: 303-675-2175 or 800-344-3860 Toll Free USA/Canada
Fax: 303-675-2176 or 800-344-3867 Toll Free USA/Canada
Email: orderlit@onsemi.com

N. American Technical Support: 800-282-9855 Toll Free
USA/Canada
Europe, Middle East and Africa Technical Support:
Phone: 421 33 790 2910
Japan Customer Focus Center
Phone: 81-3-5773-3850

ON Semiconductor Website: www.onsemi.com
Order Literature: <http://www.onsemi.com/orderlit>

For additional information, please contact your local Sales Representative