

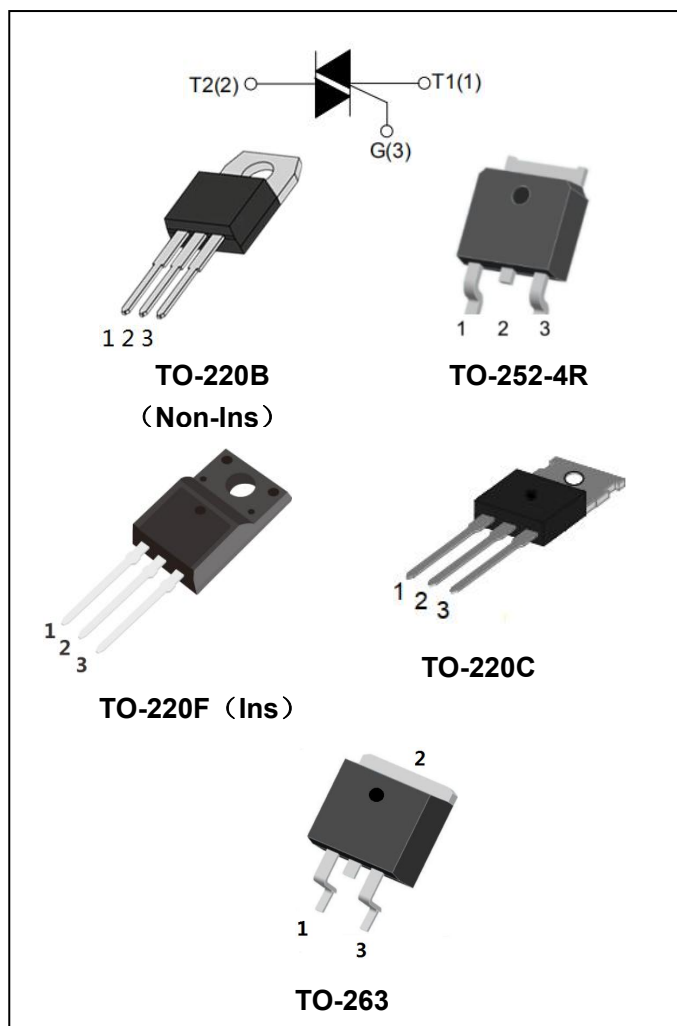

BT137 Series 8A Triacs

DESCRIPTION:

With low holding and latching current, BT137 Series triacs are especially recommended for use on middle and small resistance type power load.



MAIN FEATURES:

symbol	value	unit
$I_{T(RMS)}$	8	A
V_{DRM}/V_{RRM}	600/800	V
V_{TM}	≤ 1.6	V

ABSOLUTE MAXIMUM RATINGS:

Parameter	Symbol	Value	Unit
Storage junction temperature range	T_{stg}	-40~150	$^{\circ}C$
Operating junction temperature range	T_j	-40~125	$^{\circ}C$
Repetitive peak off-state voltage ($T_j=25^{\circ}C$)	V_{DRM}	600/800	V
Repetitive peak reverse voltage ($T_j=25^{\circ}C$)	V_{RRM}	600/800	V
RMS on-state current	$I_{T(RMS)}$	8	A
Non repetitive surge peak on-state current (full cycle, F=50Hz)	I_{TSM}	65	A
I^2t value for fusing ($t_p=10ms$)	I^2t	21	A^2s



Jiangsu Weida Semiconductor Co., Ltd.

BT137 Series 8A Triacs

Critical rate of rise of on-state current ($I_G=2 \times I_{GT}$)	di/dt	I - II - III	50	A/ μ s
		IV	10	
Peak gate current		I_{GM}	2	A
Average gate power dissipation		$P_{G(AV)}$	0.5	W
Peak gate power		P_{GM}	5	W

ELECTRICAL CHARACTERISTICS ($T_j=25^\circ\text{C}$ unless otherwise specified)

Parameter	Test Condition	Quadrant		Value				Unit
				D	E	F	G	
I_{GT}	$V_D=12\text{V}, R_L=33\Omega$	I - II - III	MAX	5	10	25	50	mA
		IV		10	25	70	100	
V_{GT}		I - II - III - IV		1.3				V
V_{GD}	$V_D=V_{DRM}$	I - II - III - IV	MIN	0.2				V
I_H	$I_T=100\text{mA}$		MAX	10	20	40	60	mA
I_L	$I_G=1.2I_{GT}$	I - III - IV	MAX	10	30	50	70	mA
		II		20	40	70	100	
dV/dt	$V_D=0.66 \times V_{DRM}$ $T_j=125^\circ\text{C}$ Gate open		MIN	20	50	100	200	V/ μ s

STATIC CHARACTERISTICS

Symbol	Test Condition			Value	Unit
V_{TM}	$I_{TM}=10\text{A}$ $t_p=380\mu\text{s}$	$T_j=25^\circ\text{C}$	MAX	1.6	V
I_{DRM} I_{RRM}	$V_{DRM}=V_{RRM}$	$T_j=25^\circ\text{C}$	MAX	5	μA
		$T_j=125^\circ\text{C}$		0.5	mA



Jiangsu Weida Semiconductor Co., Ltd.

BT137 Series 8A Triacs

THERMAL RESISTANCES

Symbol	Test Condition	Value	Unit
$R_{th(j-c)}$	TO-252-4R	2.0	°C/W
	TO-220B(Non-Ins)/ TO-220C	1.8	
	TO-220F	2.8	
	TO-263	3.0	

ORDERING INFORMATION

BT Triacs	137-600 $I_{T(RMS)}:8A$	D V_{DRM}, V_{RRM} : 600: 600V 800: 800V	D: $I_{GT1-3} \leq 5mA, I_{GT4} \leq 10mA$ E: $I_{GT1-3} \leq 10mA, I_{GT4} \leq 25mA$ F: $I_{GT1-3} \leq 25mA, I_{GT4} \leq 70mA$ G: $I_{GT1-3} \leq 50mA, I_{GT4} \leq 100mA$
---------------------	-----------------------------------	--	--

PACKAGE MECHANICAL DATA

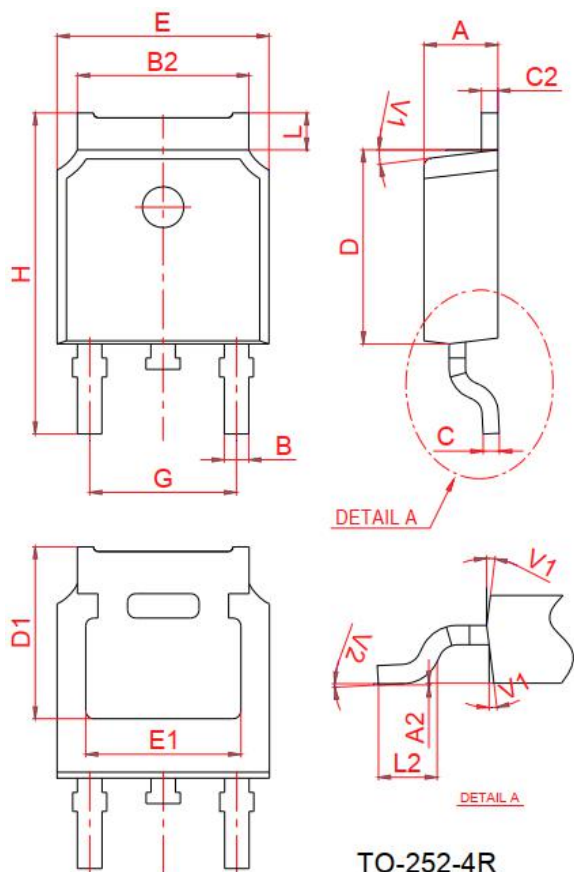

Ref.	Dimensions					
	Millimeters			Inches		
	Min.	Typ.	Max.	Min.	Typ.	Max.
A	2.2		2.4	0.087		0.094
A2	0		0.1	0		0.004
B	0.66		0.86	0.026		0.034
B2	5.1		5.46	0.201		0.215
C	0.46		0.58	0.018		0.023
C2	0.44		0.58	0.017		0.023
D	5.9		6.3	0.232		0.248
D1	5.30REF			0.211REF		
E	6.4		6.8	0.252		0.268
E1	4.63			0.182		
G	4.372		4.772	0.172		0.188
H	9.8		10.4	0.386		0.409
L	1.09		1.21	0.043		0.048
L2	1.35		1.65	0.053		0.065
V1		7°			7°	
V2	0°		6°	0°		6°



Jiangsu Weida Semiconductor Co., Ltd.

BT137 Series 8A Triacs

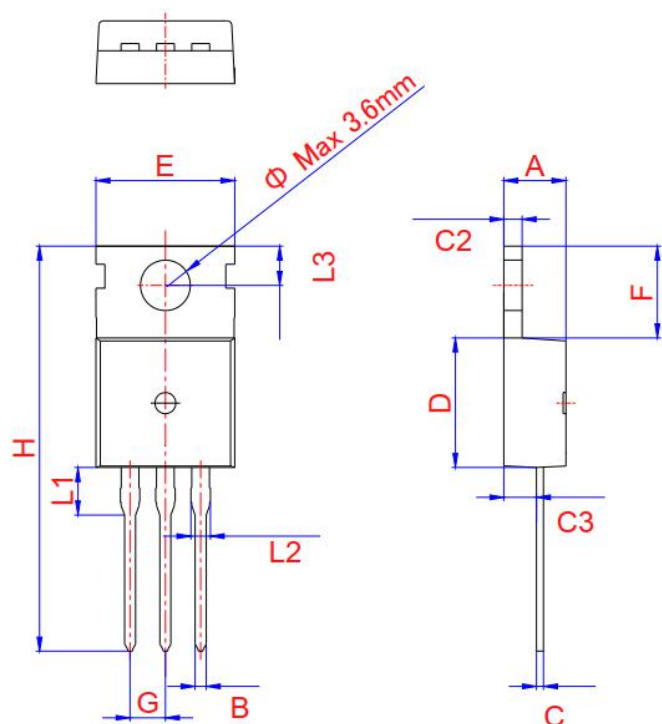

TO-220C

Ref.	Dimensions					
	Millimeters			Inches		
	Min.	Typ.	Max.	Min.	Typ.	Max.
A	4.3		4.5	0.169		0.177
B	0.7		0.9	0.028		0.035
C	0.45		0.6	0.018		0.024
C2	1.23	1.30	1.32	0.048	0.051	0.052
C3	2.2		2.6	0.087		0.102
D	8.9		9.9	0.35		0.39
E	9.9	10.1	10.3	0.39	0.398	0.406
F	6.3		6.9	0.248		0.272
G		2.54			0.1	
H	28		29.8	1.102		1.173
L1		3.39			0.133	
L2	1.14		1.7	0.045		0.067
L3	2.65		2.95	0.104		0.116
Φ		3.6			0.142	

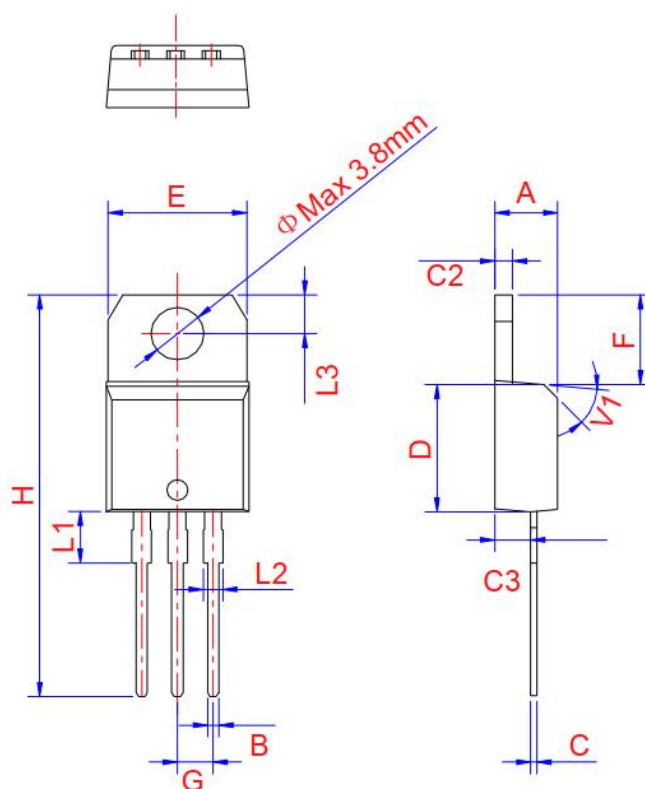

TO-220B Non-Ins

Ref.	Dimensions					
	Millimeters			Inches		
	Min.	Typ.	Max.	Min.	Typ.	Max.
A	4.4	4.47	4.6	0.173	0.176	0.181
B	0.61		0.88	0.024		0.035
C	0.46	0.50	0.7	0.018	0.02	0.028
C2	1.21	1.27	1.32	0.048	0.050	0.052
C3	2.4		2.72	0.094		0.107
D	8.6		9.7	0.339		0.382
E	9.8		10.4	0.386		0.409
F	6.55		6.95	0.258		0.274
G		2.54			0.1	
H	28		29.8	1.102		1.173
L1		3.75			0.148	
L2	1.14		1.7	0.045		0.067
L3	2.65		2.95	0.104		0.116
V1		45°			45°	



Jiangsu Weida Semiconductor Co., Ltd.
BT137 Series 8A Triacs

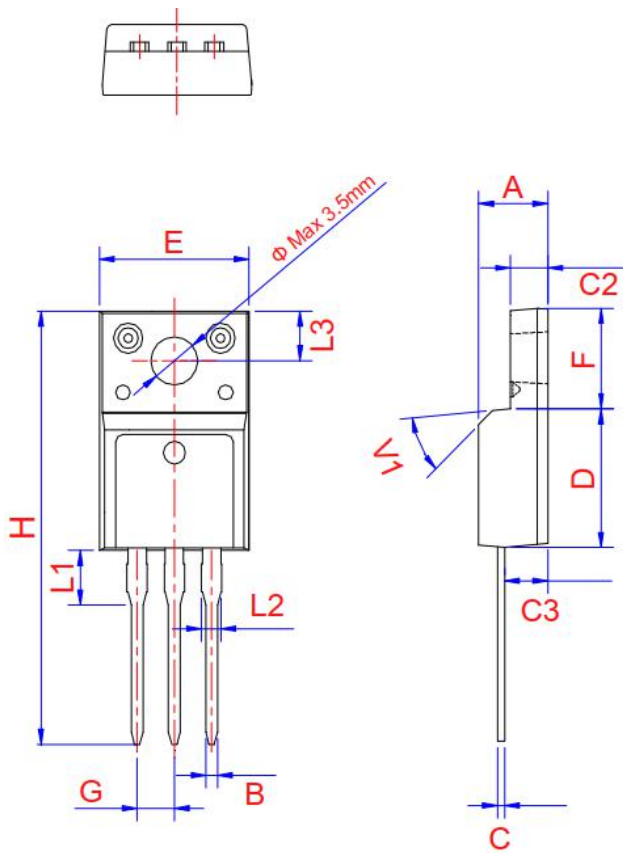

TO-220F Ins

Ref.	Dimensions					
	Millimeters			Inches		
	Min.	Typ.	Max.	Min.	Typ.	Max.
A	4.5		4.9	0.177		0.193
B	0.74	0.8	0.83	0.029	0.031	0.033
C	0.47		0.65	0.019		0.026
C2	2.45		2.75	0.096		0.108
C3	2.6		3	0.102		0.118
D	8.8		9.3	0.346		0.366
E	9.8		10.4	0.386		0.41
F	6.4		6.8	0.252		0.268
G		2.54			0.1	
H	28		29.8	1.102		1.173
L1		3.63			0.148	
L2	1.14		1.7	0.045		0.067
L3	2.65	3.3	0		0.13	0.116
V1		45°			45°	

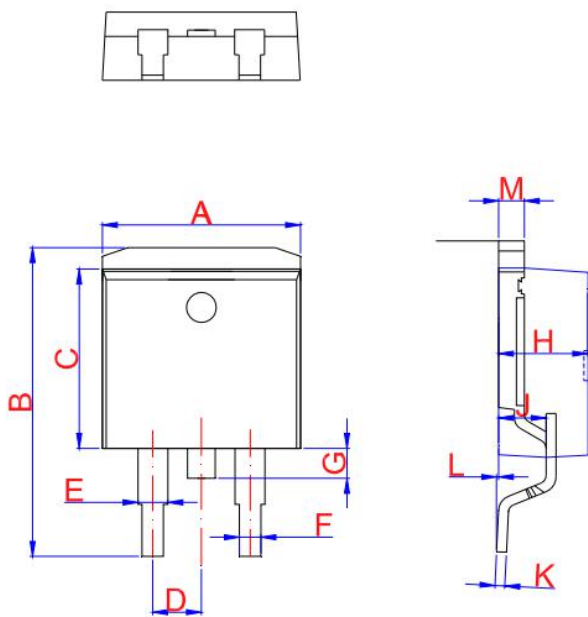

TO-263

Ref.	Dimensions					
	Millimeters			Inches		
	Min.	Typ.	Max.	Min.	Typ.	Max.
A	9.9		10.3	0.390		0.406
B	14.7		15.8	0.579		0.622
C	8.5		8.9	0.370		0.378
D		2.54			0.100	
E	1.20		1.40	0.047		0.055
F	0.75		0.85	0.029		0.033
G			1.75			0.069
H	4.40	4.60	4.80	0.173	0.181	0.189
J	2.40	2.60	2.80	0.094	0.102	0.110
L	0	0.1	0.25	0	0.004	0.010
M	1.17	1.27	1.37	0.046	0.05	0.054



Jiangsu Weida Semiconductor Co., Ltd.

BT137 Series 8A Triacs

FIG.1: Maximum power dissipation versus RMS on-state current

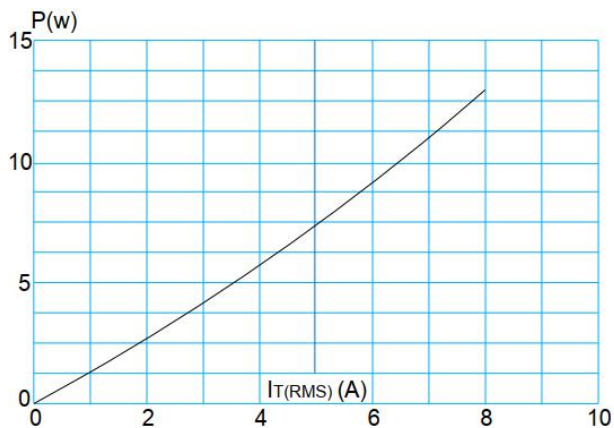

FIG.2: RMS on-state current versus case temperature

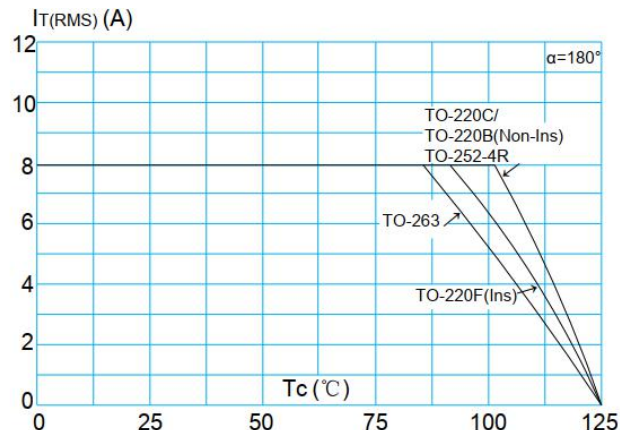

FIG.3: Surge peak on-state current versus number of cycles

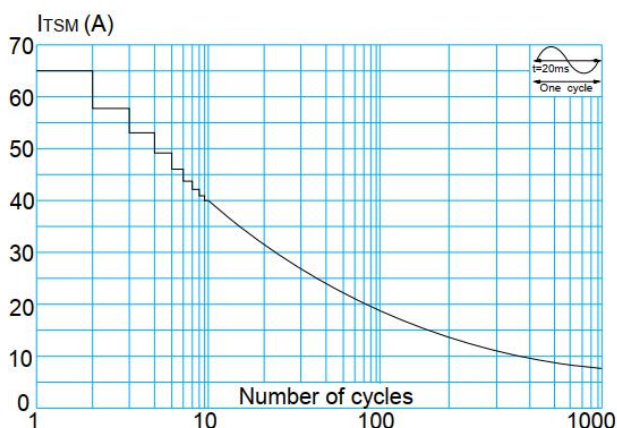

FIG.4: On-state characteristics (maximum values)

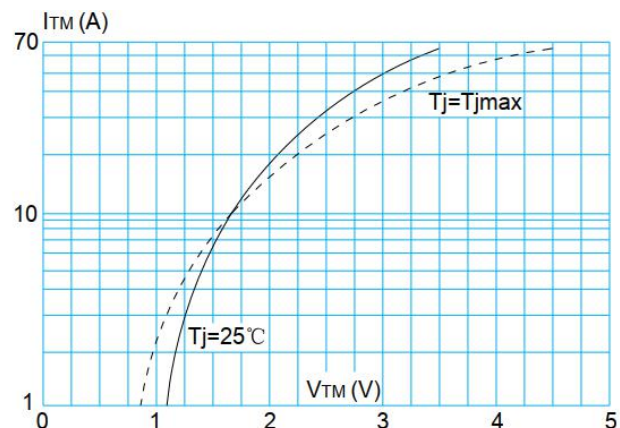

FIG.5: Non-repetitive surge peak on-state current for a sinusoidal pulse with width $t_p < 20\text{ms}$, and corresponding value of I^2t ($I - II - III: dI/dt < 50\text{A}/\mu\text{s}; IV: dI/dt < 10\text{A}/\mu\text{s}$)

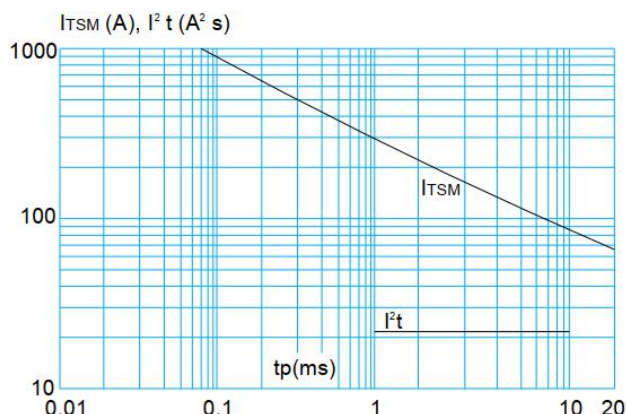
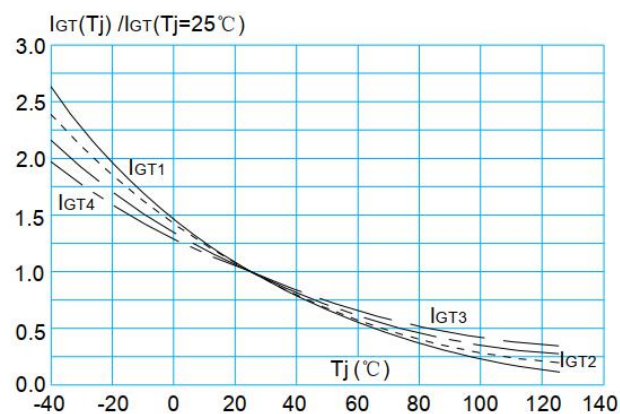

FIG.6: Relative variations of gate trigger current versus junction temperature





Jiangsu Weida Semiconductor Co., Ltd.

BT137 Series 8A Triacs

FIG.7: Relative variations of holding current versus junction temperature

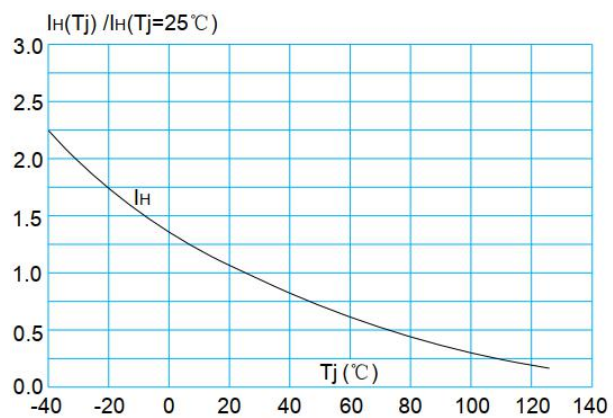
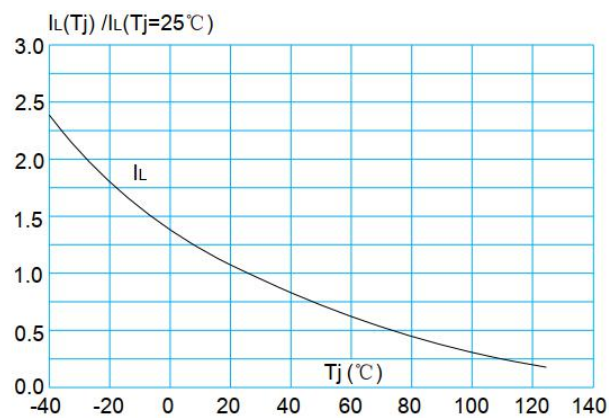

FIG.8: Relative variations of latching current versus junction temperature





Jiangsu Weida Semiconductor Co., Ltd.

BT137 Series 8A Triacs

Information furnished in this document is believed to be accurate and reliable. However, Jiangsu Weida Semiconductor Co., Ltd assumes no responsibility for the consequences of use without consideration for such information nor use beyond it.

Information mentioned in this document is subject to change without notice, apart from that when an agreement is signed, Jiangsu Weida Semiconductor Co., Ltd complies with the agreement.

Products and information provided in this document have no infringement of patents. Jiangsu Weida Semiconductor Co., Ltd assumes no responsibility for any infringement of other rights of third parties which may result from the use of such products and information.