

International
IOR Rectifier

16CTQ...
 16CTQ...S
 16CTQ...-1

SCHOTTKY RECTIFIER

16 Amp

Major Ratings and Characteristics

Characteristics	Values	Units
$I_{F(AV)}$ Rectangular waveform	16	A
V_{RRM}	60/100	V
I_{FSM} @ tp = 5 μ s sine	850	A
V_F @ 8Apk, $T_J = 125^\circ\text{C}$ (per leg)	0.58	V
T_J range	-55 to 175	$^\circ\text{C}$

Description/ Features

This center tap Schottky rectifier series has been optimized for low reverse leakage at high temperature. The proprietary barrier technology allows for reliable operation up to 175°C junction temperature. Typical applications are in switching power supplies, converters, free-wheeling diodes, and reverse battery protection.

- 175° C T_J operation
- Center tap configuration
- Low forward voltage drop
- High purity, high temperature epoxy encapsulation for enhanced mechanical strength and moisture resistance
- High frequency operation
- Guard ring for enhanced ruggedness and long term reliability

Case Styles

16CTQ...	16CTQ...S	16CTQ...-1
		
TO-220	D ² PAK	TO-262

Voltage Ratings

Parameters	16CTQ060 16CTQ060S 16CTQ060-1	16CTQ80 16CTQ80S 16CTQ80-1	16CTQ100 16CTQ100S 16CTQ100-1
V_R Max. DC Reverse Voltage (V)	60	80	100
V_{RWM} Max. Working Peak Reverse Voltage (V)			

Absolute Maximum Ratings

Parameters	Values	Units	Conditions
$I_{F(AV)}$ Max. Average Forward Current (Per Leg) * See Fig. 5 (Per Device)	8	A	50% duty cycle @ $T_C = 148^\circ\text{C}$, rectangular wave form
	16		
I_{FSM} Max. Peak One Cycle Non-Repetitive Surge Current (Per Leg) * See Fig. 7	850	A	5 μs Sine or 3 μs Rect. pulse 10ms Sine or 6ms Rect. pulse
	275		
E_{AS} Non-Repetitive Avalanche Energy (Per Leg)	7.50	mJ	$T_J = 25^\circ\text{C}$, $I_{AS} = 0.50$ Amps, $L = 60$ mH
I_{AR} Repetitive Avalanche Current (Per Leg)	0.50	A	Current decaying linearly to zero in 1 μsec Frequency limited by T_J max. $V_A = 1.5 \times V_R$ typical

Electrical Specifications

Parameters	Values	Units	Conditions
V_{FM} Max. Forward Voltage Drop (Per Leg) * See Fig. 1 (1)	0.72	V	@ 8A $T_J = 25^\circ\text{C}$
	0.88	V	@ 16A
	0.58	V	@ 8A $T_J = 125^\circ\text{C}$
	0.69	V	@ 16A
I_{RM} Max. Reverse Leakage Current (Per Leg) * See Fig. 2 (1)	0.55	mA	$T_J = 25^\circ\text{C}$
	7.0	mA	$T_J = 125^\circ\text{C}$ $V_R = \text{rated } V_R$
$V_{F(TO)}$ Threshold Voltage	0.415	V	$T_J = T_J \text{ max.}$
r_t Forward Slope Resistance	11.07	m Ω	
C_T Max. Junction Capacitance (Per Leg)	500	pF	$V_R = 5V_{DC}$, (test signal range 100Khz to 1Mhz) 25°C
L_S Typical Series Inductance (Per Leg)	8.0	nH	Measured lead to lead 5mm from package body
dv/dt Max. Voltage Rate of Change (Rated V_R)	10000	V/ μs	

(1) Pulse Width < 300 μs , Duty Cycle <2%

Thermal-Mechanical Specifications

Parameters	Values	Units	Conditions
T_J Max. Junction Temperature Range	-55 to 175	$^\circ\text{C}$	
T_{stg} Max. Storage Temperature Range	-55 to 175	$^\circ\text{C}$	
R_{thJC} Max. Thermal Resistance Junction to Case (Per Leg)	3.25	$^\circ\text{C/W}$	DC operation
R_{thJC} Max. Thermal Resistance Junction to Case (Per Package)	1.63	$^\circ\text{C/W}$	DC operation
R_{thCS} Typical Thermal Resistance, Case to Heatsink	0.50	$^\circ\text{C/W}$	Mounting surface, smooth and greased (only for TO-220)
wt Approximate Weight	2(0.07)	g(oz.)	
T Mounting Torque	Min.	6(5)	Kg-cm (lbf-in)
	Max.	12(10)	

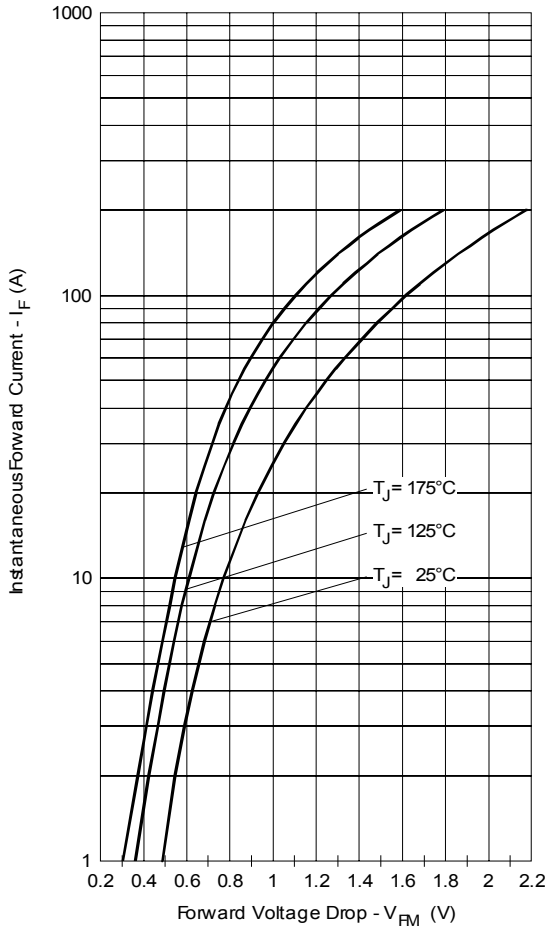

Fig. 1 - Max. Forward Voltage Drop Characteristics (PerLeg)

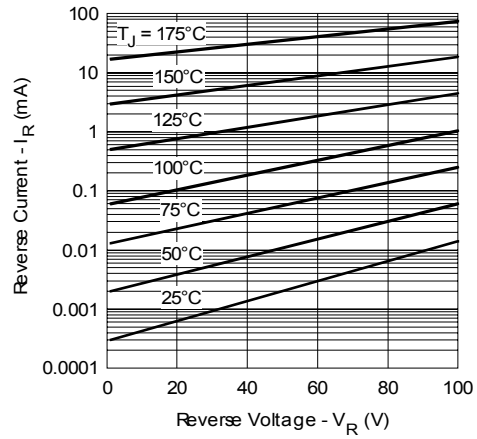

Fig. 2 - Typical Values Of Reverse Current Vs. Reverse Voltage (Per Leg)

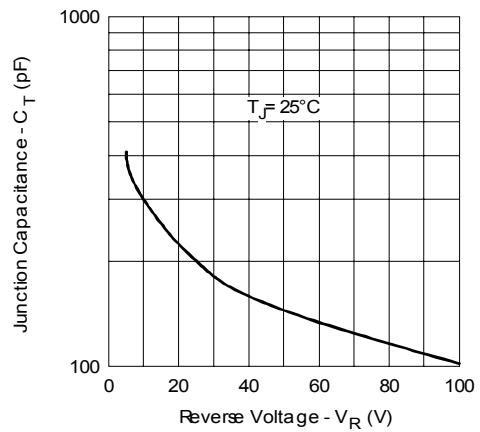

Fig. 3 - Typical Junction Capacitance Vs. Reverse Voltage (Per Leg)

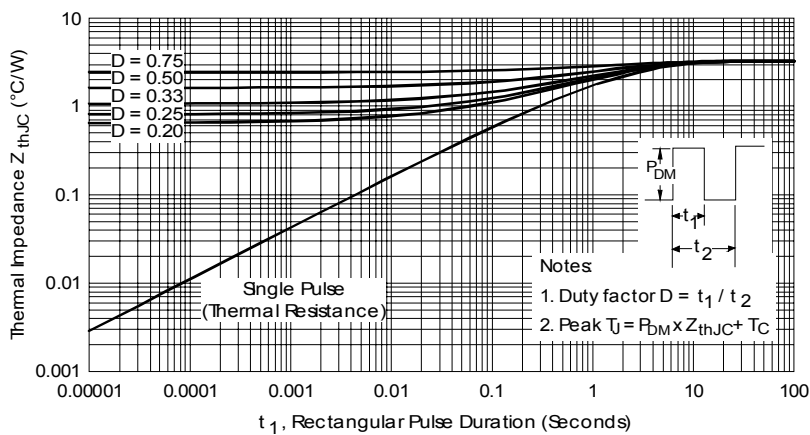

Fig. 4 - Max. Thermal Impedance Z_{thJC} Characteristics (Per Leg)

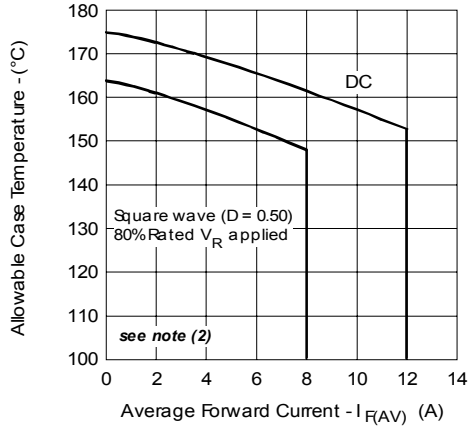

Fig. 5- Max. Allowable Case Temperature Vs. Average Forward Current (PerLeg)

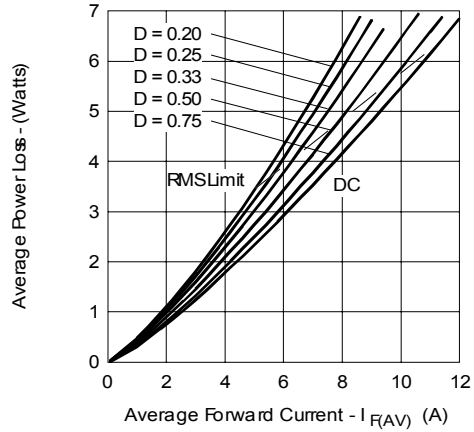

Fig. 6- Forward Power Loss Characteristics (PerLeg)

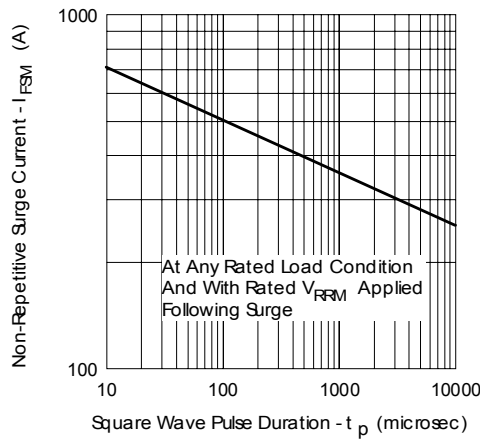

Fig. 7- Max. Non-Repetitive Surge Current (PerLeg)

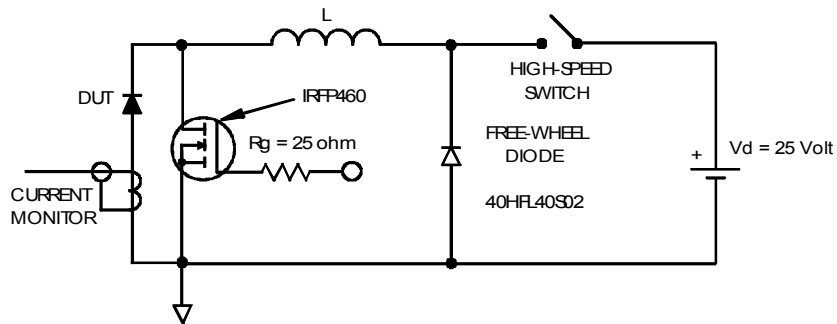

Fig. 8- Unclamped Inductive Test Circuit

(2) Formula used: $T_c = T_j - (P_d + P_{d_{REV}}) \times R_{thJC}$;

P_d = Forward Power Loss = $I_{F(AV)} \times V_{FM} @ (I_{F(AV)} / D)$ (see Fig. 6);

$P_{d_{REV}}$ = Inverse Power Loss = $V_{R1} \times I_R (1 - D)$; $I_R @ V_{R1} = 10 V$

Outline Table

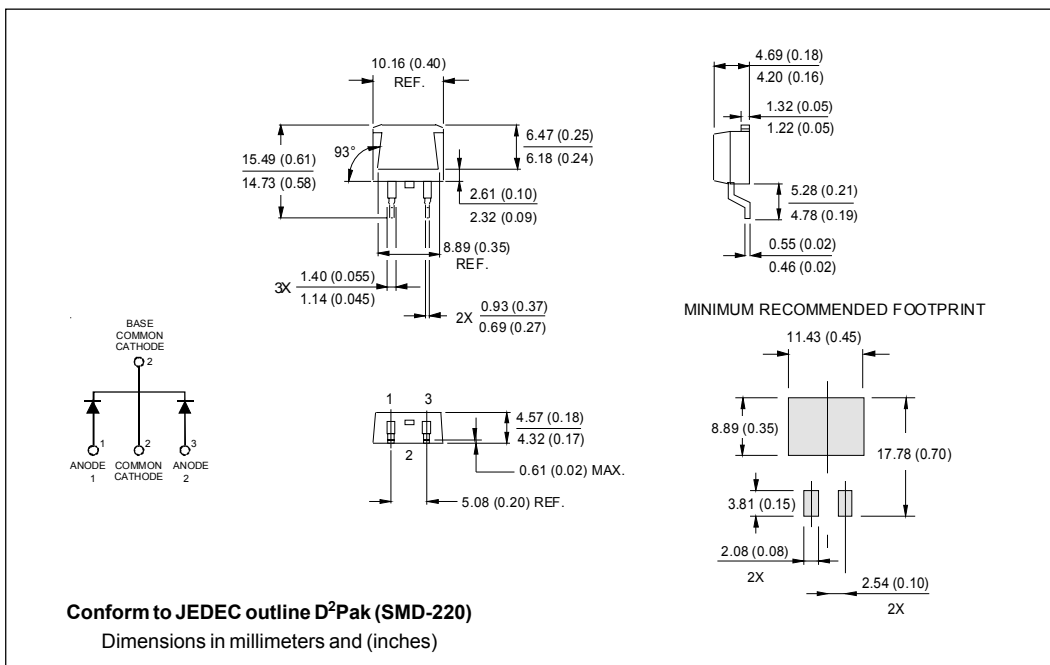
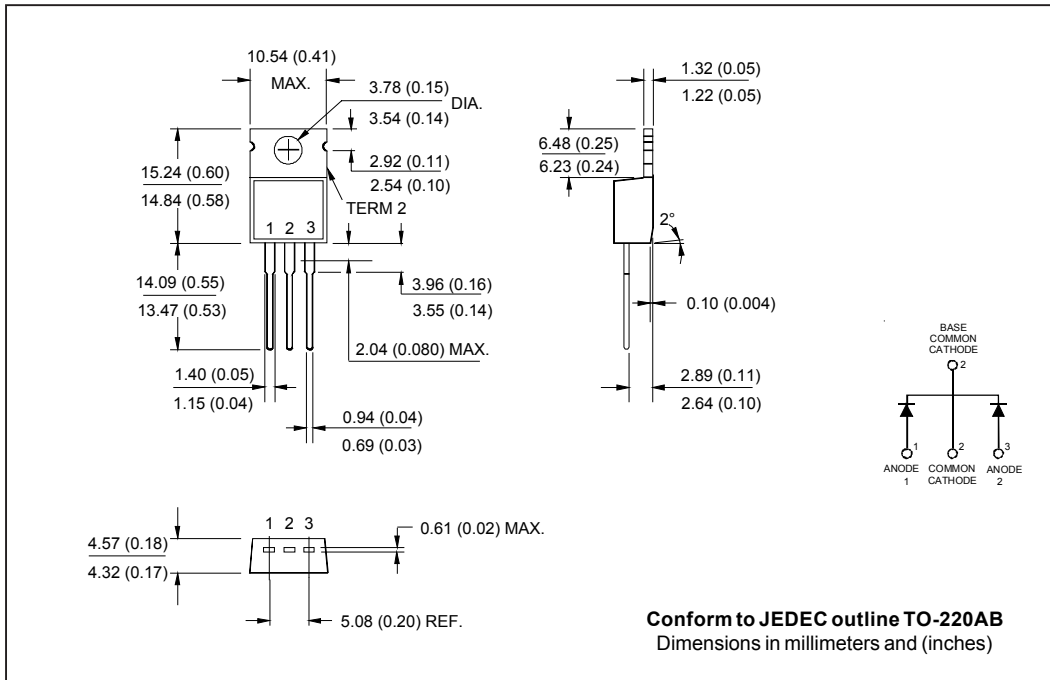

Outline Table

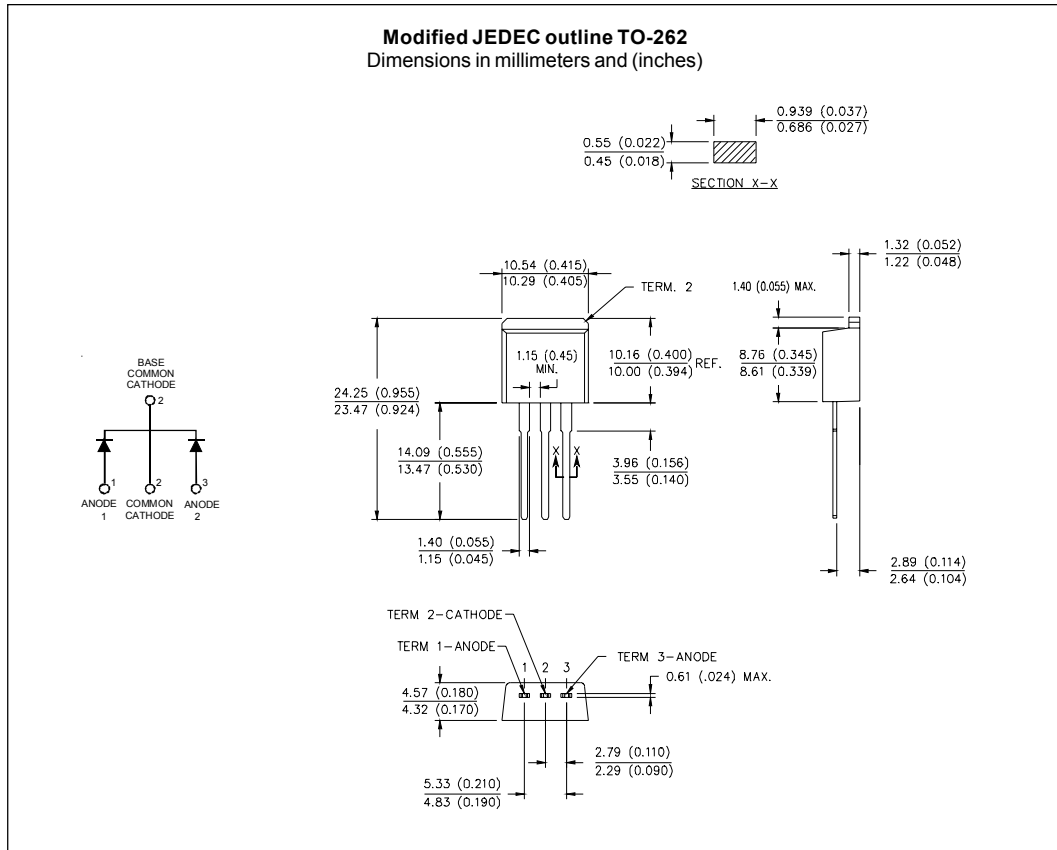

Marking Information

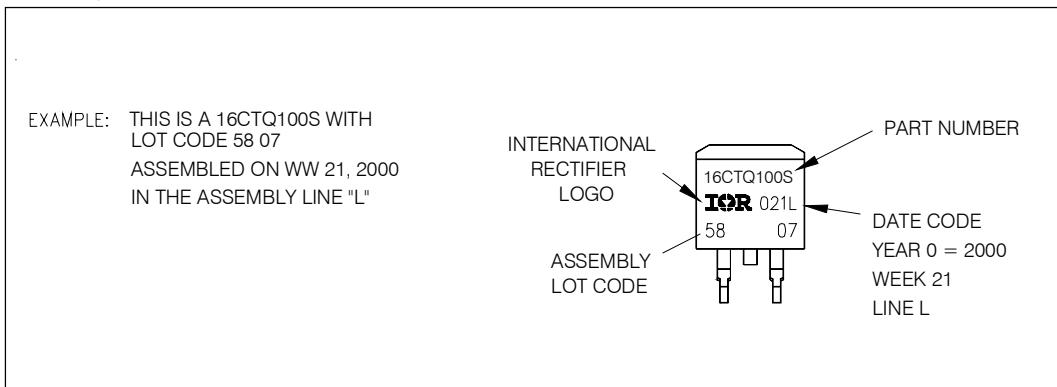

```

16CTQ100
*****
* SPICE Model Diode *
*****
.SUBCKT 16CTQ100 ANO CAT
D1 ANO 1 DMOD (0.07089)
*Define diode model
.MODEL DMOD D(IS=21.21E-06,N=1.578,RS=7.804E-03,Ikf=0.9497,Xti=2,Eg=1.11
+ Cjo=1.278E-09,M=0.4736,Vj=0.4972,Fc=0.5,Isr=1.114e-21,Nr=4.755,
+ Bv=119.9,Ibv=215.5E-06,Tt=18.2E-09)
*****

.ENDS 16CTQ100

Thermal Model Subcircuit
.SUBCKT 16CTQ100 5 1

CTHERM1      5   4   1.45E+00
CTHERM2      4   3   4.54E+00
CTHERM3      3   2   1.09E+01
CTHERM4      2   1   1.01E+02

RTHERM1      5   4   2.49E+00
RTHERM2      4   3   5.20E-04
RTHERM1      3   2   5.43E-01
RTHERM1      2   1   3.05E-02

.ENDS 16CTQ100

```

Data and specifications subject to change without notice.
This product has been designed and qualified for Industrial Level.
Qualification Standards can be found on IR's Web site.

International
IR Rectifier

IR WORLD HEADQUARTERS: 233 Kansas St., El Segundo, California 90245, USA Tel: (310) 252-7105
TAC Fax: (310) 252-7309
Visit us at www.irf.com for sales contact information. 03/04